

Radley®

Portable Inverter Generator



2500
Starting watts

1900
Running watts

Owner's Manual
3 Year limited
warranty



Intertek
5017208

**READ ALL INSTRUCTIONS BEFORE FIRST USE.
KEEP THIS MANUAL FOR FUTURE REFERENCE.
KEEP AWAY FROM CHILDREN.**



**WEAR CSA APPROVED
EYE PROTECTION**



**WEAR EAR
PROTECTION**



**WEAR A
FACE MASK**

PRODUCT SPECIFICATIONS

Model:	BQH2000
Engine Model:	148F-D
Style:	OHV
Displacement (cm ³):	79
Ignition System:	CDI
Start style:	Hand recoil starting
Oil capacity (L):	0.5
Frequency (Hz):	60
Voltage (V):	120
Rated power (kW):	1.9
Maximum power (kW):	2.1
Power factor:	1
Insulation rate:	F
Fuel capacity (L):	4
Operating Temperature (°C)	-5~40
Max. site altitude of installation (m):	1500
Measured sound pressure level (dB(A)):	≤72
Measurement uncertainty (dB(A)):	≤1.5
Guaranteed sound power level (dB(A)):	≤92
Net weight (kg):	18.3

Notes: The generator with different specification and configurations may have different parameters and may change at any time without notice.

Customer Service/Tech Support

1-866-206-0888

www.mecanair.net

TABLE OF CONTENTS

Product specifications1
Table of contents2
Operating safety3
Features and controls7
Operating checklist11
Starting the generator15
Connect to electrical devices17
Stopping the generator19
Parallel operation20
Maintenance21
Maintenance schedule21
Generator maintenance22
Engine maintenance23
Troubleshooting26
Storage and transportation27
Wiring diagram28
Warranty statements29
Parts schematic35
Parts List36

OPERATING SAFETY



Pay attention to this safety alert symbol. Obey all safety messages that follow this symbol to avoid possible property damage, **INJURY** or **DEATH**.

Each safety message is preceded by a safety alert symbol and one of three words, **DANGER**, **WARNING** or **CAUTION**.

DANGER

Indicates a hazardous situation which, if not strictly complied with, will result in substantial property damage, serious injury or DEATH.

WARNING

Indicates a hazardous situation which, if not strictly complied with, may result in property damage, serious injury or DEATH.

CAUTION

Indicates a hazardous situation which, if not strictly complied with, could result in property damage or injury.

WARNING

READ THIS MANUAL COMPLETELY BEFORE OPERATING.

DO NOT operate this generator until you have read ALL safety, operation, and maintenance instructions listed in this manual.

Failure to follow the instructions may result in property damage, INJURY or DEATH.

The warnings and precautions discussed in this manual cannot cover all possible conditions and situations that may occur. It must be understood by the operator that common sense and caution are factors which cannot be built into this product, but must be supplied by the operator.

WARNING

This generator is intended for residential consumer use only.

Air cooled generators cannot be run full time.

No person modifies any part of the generator or any unsuitable usage is allowed.

⚠ DANGER**TOXIC FUMES**

Using a generator indoors CAN KILL YOU IN MINUTES.

Generator exhaust contains carbon monoxide. This is a poison you cannot see or smell. NEVER use inside a home or garage, EVEN IF doors and windows are open. Only use OUTSIDE and far away from open windows, doors, and vents.

⚠ WARNING

CHARGE ONLY 12V LEAD-ACID TYPE BATTERIES. OTHER TYPES OF BATTERIES MAY BURST CAUSING PERSONAL INJURY AND DAMAGE.

RISK OF EXPLOSIVE GAS MIXTURE. READ INSTRUCTIONS BEFORE USING CHARGER.

⚠ WARNING**FIRE**

Operation of this generator may create sparks that can start fires around dry vegetation. This generator may not be equipped with a spark arresting muffler. If the generator will be used around flammable materials, or on land covered with materials such as agricultural crops, forest, brush, grass, or other similar items, then an approved spark arrester must be installed.

In some areas, a spark arrester is required by law. Please contact local fire agencies for laws or regulations relating to fire prevention requirements.

⚠ WARNING**KICKBACK**

Rapid retraction of the starter cord will pull hand and arm towards the generator faster than you can let go.

Unintentional startup can result in an accident.

⚠ WARNING**HOT SURFACE**

Running the generator produces heat. Severe burns can occur on contact.

DO NOT touch generator while operating or just after stopping. Avoid contact with hot exhaust gases.

Maintain at least three feet of clearance on all sides to ensure adequate cooling. Combustible material can catch fire on contact. Maintain at least five feet of clearance from combustible materials.

DANGER



FIRE OR EXPLOSION

Gasoline is highly flammable and extremely explosive.

Fire or explosion can cause severe burns or death.

Keep flammable items away while handling gasoline.

Fill fuel tank outdoors and in a well-ventilated area with the generator stopped.

Always wipe off spilled fuel and wait until the fuel has dried before starting the generator.

DO NOT operate the generator with known leaks in the fuel system.

Use proper fuel storage and handling procedures.

DO NOT store fuel or other flammable materials nearby.

Empty the fuel tank before storing or transporting this generator.

Keep fire extinguisher handy and be prepared if a fire starts.

WARNING



Before each use, check for loose or damaged parts, signs of oil or fuel leaks, and any other condition that may affect proper operation. Repair or replace all damaged or defective parts immediately.

Locate all operating controls and safety labels.

Make sure all the safety guards are in right and working condition. Operate only on level surfaces.

DO NOT expose generator to excessive moisture, dust, or dirt.

Keep all safety guards in place and in proper working order at all times.

DO NOT allow any material to block the cooling slots.

DO NOT allow children or untrained persons to operate the generator.

DO NOT run the generator unattended. Turn off the generator before leaving the area.

DANGER



MOVING PARTS

Moving parts can cause severe injury. Keep hands and feet away.

DO NOT operate generator with covers, shrouds, or guards removed.

DO NOT wear loose-fitting clothing, dangling drawstrings or items that could become caught. Tie up long hair and remove jewelry.

The moving parts may catch operator's hand, feet, hair or clothes such that will cause traumatic amputation or broken bones, fracture.

NEVER place fingers, hands, or body near the generator when it is running.

⚠ DANGER**ELECTRICAL SHOCK**

This generator produces powerful voltage and the electricity CAN KILL YOU.

This generator must be properly connected to an appropriate ground to help prevent electric shock. Failure to properly ground the generator can result in electrocution, especially if the generator is equipped with a wheel kit.

Consult an electrician for local grounding requirements.

Installation should be performed by a certified electrician.

Improper installation can result in electrical shock and death.

To reduce the risk of electrical shock. DO NOT use electrical cords that are worn, frayed, bare or otherwise damaged.

DO NOT touch bare wires or receptacles.

DO NOT operate the generator in wet weather. Keep the generator dry.

DO NOT handle the generator or electrical cords while standing in water, while barefoot, or while hands or feet are wet.

DO NOT allow unqualified persons or children to operate or service the generator.

DO NOT hook up any generator to a buildings electrical system without the proper use and installation of a transfer switch installed by a qualified electrician.

When using the generator for backup power, notify utility company. Use approved transfer generator to isolate the generator from electric utility.

Failure to isolate the generator from power utility can result in death or injury to electric utility workers due to back feed of electrical energy.

DO NOT expose to rain.

⚠ WARNING

Read the instructions provided and be aware of the safety procedures, set up, shut-down, operation and protective apparel to wear when operating this equipment.

NEUTRAL FLOATING:

i) THE GENERATOR (STATOR WINDING) IS ISOLATED FROM THE FRAME AND FROM THE AC RECEPTACLE GROUND PIN.

ii) ELECTRICAL DEVICES THAT REQUIRE A GROUNDED RECEPTACLE PIN CONNECTION WILL NOT FUNCTION IF THE RECEPTACLE GROUND PIN IS NOT FUNCTIONAL.

FEATURES AND CONTROLS

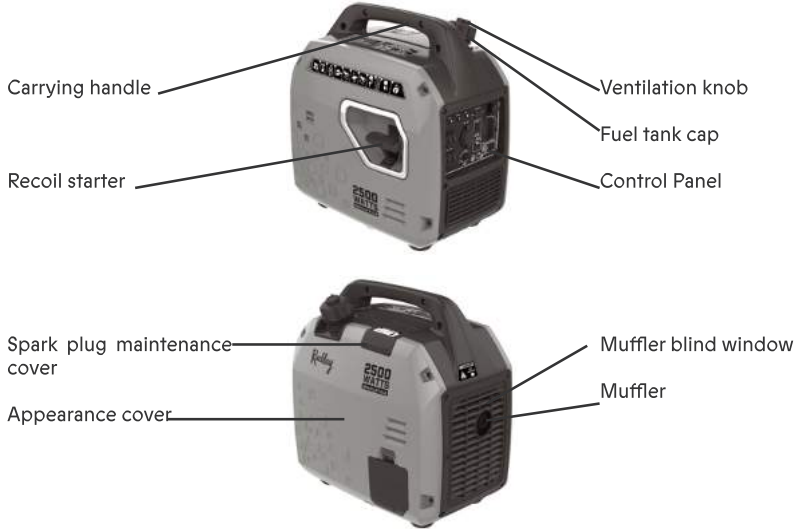

CONTROL PANEL

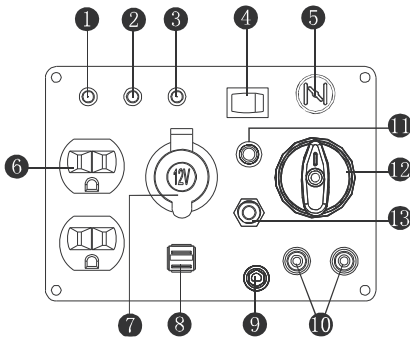

1. Running indicator
2. Overload indicator
3. Oil alarm lamp
4. Energy-saving switch
5. Choke lever
6. AC output receptacle
7. 12V DC
8. USB port
9. Ground terminal
10. Parallel kit term
11. Reset button
12. Two-in-one switch (engine stop & fuel switch)
13. AC Circuit breaker

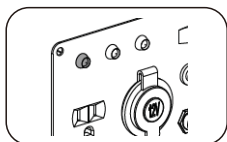

Running indicator (green)

The running indicator lights up when the generator starts and has normal output.

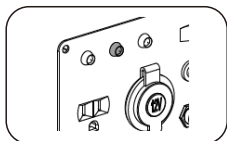

Overload indicator (red)

When the overload indicator is on, it indicates that the generator is overloaded and it may cause overheat of frequency converter, or increase of AC voltage. And then the AC protector works. It will stop the output of the generator to protect the electric equipment and the generator itself. At this time, the running indicator (green) is off and the overload indicator (red) is on, but the engine is still in running state.

When the generator has no output and the overload indicator is on, please take the following steps:

1. Lower the total power of the connected electric devices to the rated output range of the generator.
2. Check the air intake for impurities and check the control parts for abnormal situations. Handle immediately if necessary.
3. Press the reset button.

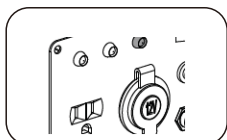

Oil alarm lamp (yellow)

When the oil level drops below the lower limit, the oil protection system will stop the engine automatically and oil alarming lamp will blink by pulling the recoil starter. The engine will not run until the oil has been filled to the proper level.

Note: If engine cuts out or fails to start, turn the two-in-one switch to "RUN" position and then pull the recoil starter. If the oil alarming lamp lights up, it shows lack of oil. Please add appropriate oil and restart the engine.

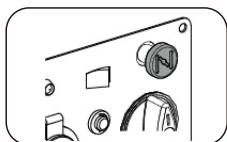

Choke lever

Note: when cold start, close (pull) the choke lever. When warm start, open (push) the choke lever.

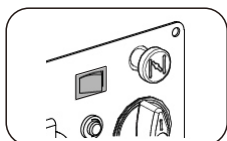

Energy-saving switch

When the energy-saving switch is in "ON" position, the energy saving equipment controls the engine rotate speed according to the connected loads. There will be good fuel consumption and low noise.

When the energy-saving switch is in "OFF" position, the engine will always run in rated rotate speed no matter if it is connected to the loads or not.

Note: Please set the energy-saving switch to "OFF" position

when connecting to air compressor, sump pump etc., because this equipment needs a large starting current.

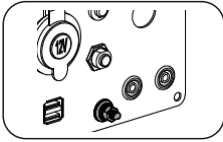

Grounding terminal

The grounding terminal is designed to prevent electric shock by connecting it to the grounding wire. The generator must be properly grounded before operating.

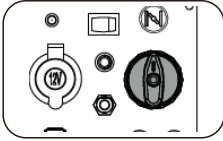

Two-in-one switch (engine stop & fuel switch)

When the switch is in "OFF" position, it indicates that the engine stop switch and fuel switch off.

When the switch is in "RUN" position, it indicates that the engine stop switch and fuel switch are on.

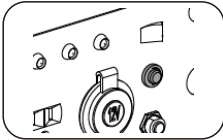

Reset button

The reset button is used to restore output if an overload occurs. To restore output, reduce the loads and press the reset button.

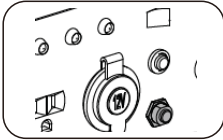

Circuit breaker

The circuit breaker protects the generator against electrical overloads.

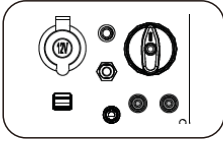

Parallel kit terminal

It is used for parallel operation with another inverter (parallel kit sold separately).

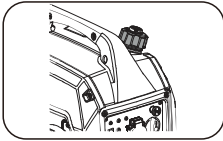

Fuel tank cap

Remove the fuel tank cap by rotating it counterclockwise.

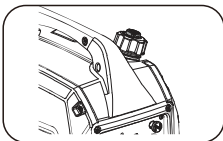

Ventilation knob

The fuel tank cap is equipped with the ventilation knob to prevent leakage of fuel. The ventilation knob must be in the 'ON' position when operating the generator. This injects the fuel into the carburetor and then drives the engine. Turn it to the "OFF" position to avoid fuel leakage when you are carrying or not in use.

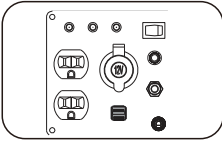

USB

Connect and charge external electrical equipment or provide 5V DC power.

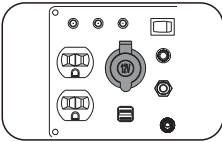

Cigarette lighter socket

Provides 12V power for the load of cigarette lighter plug category or cigarette lighter.

OPERATING CHECKLIST

1. Operating Location

Only use OUTSIDE and place the generator in a well-ventilated area.

Only operate the generator on a flat, level surface and in a clean, dry operating environment.

Allow two feet clearance on all sides of the generator while operating it outdoors.

DANGER

TOXIC FUMES

The exhaust of the generator contains carbon monoxide, Using engine indoors CAN KILL YOU!

NEVER use inside any building or any kind of enclosure, EVEN IF doors and windows are open.

Place the generator in a well-ventilated and clean area. Note the wind direction and air current when placing the generator.

High altitude

This generator may require a high altitude carburetor kit to ensure correct operation at high altitudes. If you always operate your engine at altitudes above 5,000 feet, you should look into a high altitude kit (1,500 meters).

CAUTION

Even with carburetor modification, the generator's horsepower will decrease about 3.5% for each 1,000 feet (300 meters) increase in altitude. The effect of altitude on horsepower will be greater than this if no carburetor modification is made.

CAUTION

Operating the engine at altitudes below 5,000 feet (1,500 meters) with a modified carburetor may cause the generator to overheat and result in serious engine damage. Please restore factory specifications of the carburetor at the dealer when using the engine in a low altitude area.

2. Operating Condition

Check for loose or damaged parts, signs of oil or fuel leaks, and any other conditions that may affect proper operation. Repair or replace all damaged or defective parts immediately.

WARNING

Failing to correct problem(s) before operating the unit could result in property damage, serious injury or DEATH.

Remove any excessive dirt or debris, especially around the muffler and recoil starter. DO NOT move or tip the generator during operation. Use the generator only for intended uses. If you have questions about intended use, ask your local dealer.

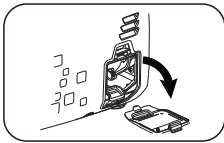

3. Engine oil check

Place the engine on a level surface with engine stopped.

Remove the oil maintenance cover.

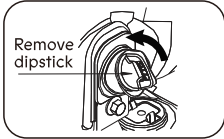

Remove dipstick

Remove the dipstick and wipe it clean.

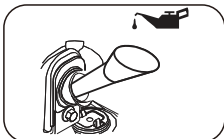

Reinstall dipstick into hole; rest on oil fill neck, DO NOT thread cap into hole.

Remove the dipstick again and check oil level. Level should be between the upper and lower limit.

Fill to the upper limit of the dipstick with the recommended oil if the oil level is low.

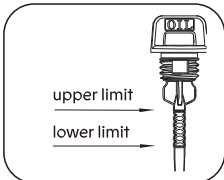

upper limit

lower limit

Reinstall and fully tighten the dipstick.

Refer to **add oil** instruction in **MAINTENANCE** section for more information.

Oil capacity(rated): See Parameters

⚠ WARNING

Oil is a major factor affecting performance and service life. Use 4-stroke automotive detergent oil recommended in the **MAINTENANCE** section of this manual.

⚠ WARNING

This engine is packaged empty and is not filled with oil. Any attempt to crank or start the engine before it has been properly filled with the recommended type and amount of oil may result in engine damage and void your warranty.

⚠ CAUTION

Operate the generator only on level surfaces. The engine is equipped with a low oil sensor (applicable types) that will automatically stop the engine when the oil level falls below the safe limit. To avoid an unexpected shutdown, fill to the upper limit and check the oil level regularly.

4. Generator fuel check

With the generator stopped, check the fuel level. Refill the fuel tank if necessary. Use clean, fresh, regular unleaded gasoline.

DO NOT mix oil with gasoline.

Always wipe up any spilled fuel.

Be sure not to fill above the upper limit mark. Always allow room for fuel expansion.

Fuel capacity (rated): See parameters

⚠ DANGER

Do not fill the fuel tank above the upper limit. Overfilling will cause engine failure or damage the carbon canister (if equipped) and void your warranty.

⚠ DANGER  

FIRE OR EXPLOSION

Gasoline is highly flammable and extremely explosive.

Keep flammable items away while handling gasoline.

Fill fuel tank outdoors and in a well-ventilated area with the generator stopped.

Always wipe off spilled fuel and wait until the fuel has dried before starting the generator.

DO NOT operate the generator with known leaks in the fuel system. Regularly check if there is any leak on fuel system.

Use proper fuel storage and handling procedures. DO NOT store fuel or other flammable materials nearby.

Keep a fire extinguisher handy and be prepared if a fire starts.

NEVER use the generator or carburetor cleaner products in the fuel tank or permanent damage may occur.

It is important to prevent gum deposits from forming in essential fuel system parts, such as the carburetor, fuel filter, fuel hose or tank during storage. Also, experience indicates that alcohol-blended fuels (called gasohol, ethanol or methanol) can attract moisture, which leads to separation and formation of acids during storage.

Acidic fuel can damage the fuel system of the generator while in storage. Be sure to review the instructions given in "Storage" section.

Gasoline/Alcohol blends: up to 10%alcohol, 90%unleaded gasoline by volume is approved as a fuel. Other gasoline/alcohol blends are not approved.

Effects of old, stale or contaminated fuel are not warrantable.

CAUTION

To minimize gum deposits in your fuel system and to insure easy starting, do not use gasoline left over from the previous season.

CAUTION

Pressure can build up in the fuel tank. Allow the generator to cool for at least two minutes before removing fuel cap.

Loosen the fuel cap slowly to release any pressure in the tank.

CAUTION

Allow the generator to cool for at least two minutes before removing fuel cap when adding fuel.

Loosen the fuel cap slowly to relieve any pressure in the tank.

5. Generator grounding

The generator must be properly connected to an appropriate ground. It helps prevent electrical shock if a ground fault condition exists in the generator or in connected electrical devices, especially when the unit is equipped with a wheel kit.

Proper grounding also helps dissipate static electricity, which often builds up in ungrounded devices.

⚠ DANGER

Electrical Shock

Failure to properly ground the generator can result in electric shock.

A ground terminal has been provided on the generator.

For remote grounding, connect a length of heavy gauge (4mm²) copper wire between the generator ground terminal and a copper rod driven into the ground.

Local electrical codes may also require proper grounding of the unit. We strongly recommend that you consult with a qualified electrician for grounding requirements in your area.

STARTING THE GENERATOR

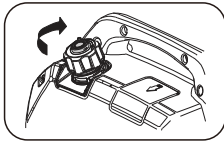

1. Perform operating checklist and remove all loads.
2. Turn the ventilation knob to "ON" position when the generator is running to make sure the fuel is flowing.

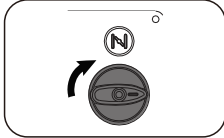

3. Turn the two-in-one switch to the "RUN" protector.

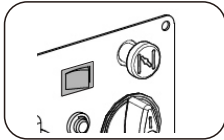

4. Turn the energy saving switch to the "ON" position. (Note: Please set the energy-saving switch to "OFF" position when it needs large starting current.)

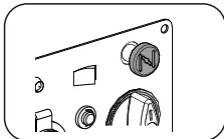

5. Pull out the choke lever to close the choke valve.

⚠ CAUTION

Choke position for starting may vary depending upon temperature and other factors. If restarting a warm engine, there's no need to pull out the choke lever.

⚠ CAUTION

Check starter cord conditions before operating. Have it replaced immediately by local authorized dealer if cord is frayed.

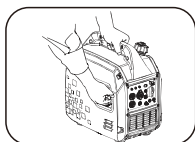
**6. Manual start**

When starting engine, grasp the recoil starter handle and pull slowly until resistance is felt. Then pull rapidly to avoid kickback. When pulling the recoil starter, firmly grasp the carrying handle to avoid tumbling of the generator.

⚠ WARNING**KICKBACK**

Rapid retraction of the starter cord will pull hand and arm towards the engine faster than you can let go. Unintentional startup can result in entanglement, traumatic amputation or laceration. Broken bones, fractures, bruises or sprains could result.

If the starter cannot drive the engine to rotate, turn off the starter immediately. Do not attempt to start the engine again before finding the causes of the fault. Prohibit the unauthorized change of other battery for restart.

⚠ WARNING

The engine start time cannot exceed 15 minutes. If the engine fails to start, allow the starting motor to cool for one minute before restarting. Failure to operate according to this rule will damage the starting motor.

⚠ CAUTION

If the engine fails to start after 3 attempts or cuts out after starting, inspect and ensure that the generator is placed on a horizontal surface and enough engine oil is injected.

If engine is equipped with an engine oil alarm, it is possible to prevent engine start when the engine oil in the crankcase is lower than the minimum level.

During running time, routinely inspect the engine oil. See maintenance section for recommended maintenance period.

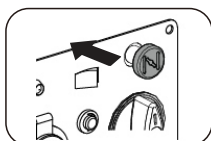

7. After the engine starts successfully, and the temperature has been increased, push the choke lever to open the choke valve. If the engine runs unstably (shaking exists), push the choke lever to the HALF open position. Then push it to the FULL open position after engine runs smoothly.

⚠ CAUTION

If the engine is warm, open the choke lever when restarting the engine.

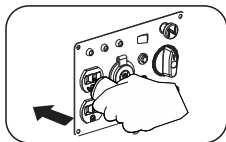

8. After all of the above operations have been done, the engine can be normally loaded.

⚠ WARNING

It is prohibited to start or close the generator when the output terminal of the generator is connected to an electric device and the electric device is "ON".

CONNECT TO ELECTRICAL DEVICES

1. Inspect power cord for damage before using. There is a hazard of electrical shock from crushing, cutting or heat damage.
2. Make sure that the generator has been properly grounded. If the electric devices require grounding, the generator must be grounded.
3. Allow the engine to stabilize and warm up for a few minutes after starting.
4. Make sure that the electric devices are in the "OFF" position.
5. Connect and start the electric devices.
6. Turn off all electric devices and disconnect them from the generator.
7. If the generator supplies for several loads or electric devices, start the smallest one first and the largest one last.

⚠ CAUTION

If connected devices overheat, turn them off and disconnect them from the generator.

**ELECTRICAL SHOCK**

To reduce the risk of electrical shock, DO NOT use electrical cords that are worn, frayed, bare or otherwise damaged.

DO NOT touch bare wires or receptacles.

DO NOT handle the generator or electrical cords while standing in water, while barefoot, or while hands or feet are wet.

Loading capacity**⚠ WARNING****DO NOT overload the generator.**

Exceeding the generator's capacity can damage the generator and/or electrical devices connected to it.

You must make sure your generator can supply enough rated (running) and (starting) watts for the electrical devices at the same time. Follow these simple steps to calculate the running and starting watts necessary for your purposes.

- a. Count the electrical devices you will power at the same time.
- b. The amount of power you need to run with the devices is the total rated (running) watts of these items.
- c. Starting power is the power needed shortly when electric devices start. Since not all devices start at the same time, starting power can be estimated by the max power of all devices plus the total power counted in step b.

⚠ WARNING

It is necessary to equip with circuit protector or switch to isolate the generator from the electric utility when the generator is mainly used for backup. Failure to isolate the generator from the power utility may result in injury or death and damage to the generator due to back feed of electrical energy.

WATTAGE REFERENCE CHART

Electric equipment		Rate power (W)	Starting power (W)
Appliances	Tablet computer 27"	80	100
	Energy saving lamp	5-50	5-50
	Electric cooker	1000	1000
	Computer	250	250
	Electric fan	50	100
	Washing machine	250	500
	Refrigerator	50	300
Power tools	Air conditioner	1600	3200
	Electric hammer	1000	1500
	Impact hammer	3000	6000
	Water pump	2200	5000
	Electric welding machine	5000	7500
	Air compressor	5000	10000

STOPPING THE GENERATOR

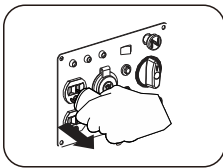

1. Remove the connectors of all electric equipment from the generator panel.

WARNING

NEVER stop the engine with electrical devices connected and running.

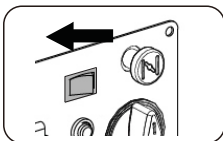

2. Turn the energy saving switch to the "ON" position.

3. Allow the generator to run with no load for a few minutes to stabilize internal temperatures of the engine and generator.

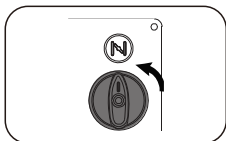

4. Turn the two-in-one switch to “OFF” position.

PARALLEL OPERATION (If applicable)

Make sure that the generator is in a good running state before connecting it to other generators. The total power of electric devices should not exceed rated power of the generator.

When electric motor starts, the overload indicator (red) will light up and normally it will stop within 4 seconds. If it cannot stop, please consult your local dealer.

During parallel operation, energy-saving switches of generators should be in the same position.

1. Connect one generator to other generator(s) in parallel. Use the parallel kit to make the parallel connection (the parallel kit needs to be purchased separately).
2. Start the engine in proper order and make sure that the running indicator (green) is normal.
3. Connect the plug of electric devices to the AC receptacle of parallel kit.
4. Run the electric devices.

⚠ CAUTION

When you overload too much, the overload indicator (red) blinks continuously, and the generator might be damaged. When you overload too little, the overload indicator (red) lights up continuously, it might shorten the service life of the generator.

When continuously operating the generator, power cannot exceed the rated power of the generator.

The total power of electric devices cannot exceed the rated power of the generator. The manufacturers of electric devices or tools always list the rated power of similar models or serial number.

MAINTENANCE

It is the operator's responsibility to complete all scheduled maintenance in a timely manner. Correct any issue before operating the generator. Always follow the inspection and maintenance recommendations and schedules in this manual.

DANGER

Accidental starts can cause severe injury or death. Remove and ground spark plug wire before performing any service.

WARNING

Improper maintenance or failure to correct a problem before operation can cause a malfunction and result in property damage, serious injury or DEATH. Improper maintenance will void your warranty.

CAUTION

The filter element may contain PAHs; PAHs are harmful for your health. Please wear gloves for protection during air filter maintenance.

MAINTENANCE SCHEDULE

Stop the generator before servicing, disconnect all electric devices and battery (if equipped), and cool down the generator completely.

Service the generator in a clean, dry and flat area, so that no accidents would happen during servicing.

Follow the service intervals indicated in the chart below. Service your generator more frequently when operating in adverse conditions.

Contact your local authorized service dealer for your generator or engine maintenance needs.

MAINTENANCE CHART

		Each time before use	The first month or 10 hours ²	Every three months or 50 hours ²	Every six months or 100 hours ²	Every year or 300 hours ²
Engine oil	Inspection	●				
	Replacement		●		●	
Air filter	Inspection	●				
	Cleaning			● ³		
Spark plug	Inspection & Adjustment				●	
	Replacement					●
Spark Extinguisher ¹	Cleaning				●	
Idle speed	Inspection & Adjustment					● ⁴
Valve clearance	Inspection & Adjustment					● ⁴
Carbon canister ¹	Inspection	Every two years ⁴				
Low permeability oil tube ¹	Inspection	Every two years ⁴				
Oil Tube	Inspection	Every two years ⁴				

NOTE:

1. Applicable types (if available).
2. Before each season and after (whichever comes first).
3. Service more frequently under severe, dusty, dirty conditions.
4. To be performed by knowledgeable, experienced owners or the authorized dealer.

GENERATOR MAINTENANCE

Use a damp cloth to clean exterior surfaces of the generator. Use a soft brush to clean the dirt and oil.

Use an air compressor (25 PSI) to clear dirt and debris from the generator.

Inspect all air vents and cooling slots to ensure that they are clean and unobstructed.

WARNING

DO NOT use water to clean the generator. Water can enter the generator through the cooling slots and damage the generator windings.

⚠ WARNING

DO NOT modify the generator in any way.

DO NOT tamper with or modify the speed regulator. Generator supplies correct rated frequency and voltage when running at factory settings.

Tampering or modifying the factory set will void your warranty.

ENGINE MAINTENANCE

Engine oil

Only use four-stroke engine oil of SJ, SL or equivalent level which are in accordance with or higher than API standard.

Check the API label on oil bottle or other container, and make sure the SJ, SL or equivalent level letter is in the label.

SAE IOW-30 is recommended for general, all-temperature use other viscosities shown in the chart may be used when the average temperature in your area is within the indicated range.

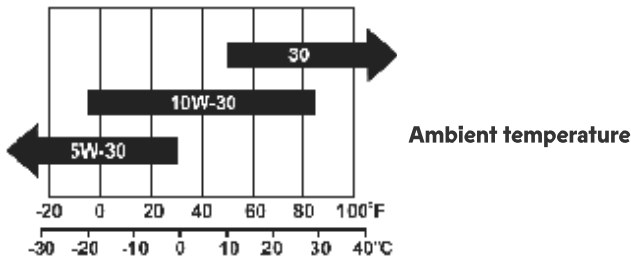

Oil capacity (rated): See parameters

Add oil

- a. Place the engine on a level surface.
- b. Remove the dipstick and wipe it clean.

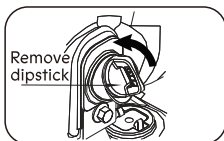

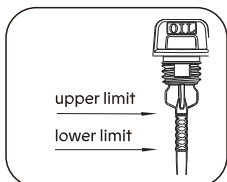
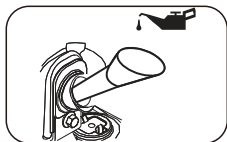

c. Add recommended oil to the upper limit.

d. Fully tighten the dipstick.

⚠ CAUTION

Oil level check

Reinstall dipstick into tube; rest on oil fill neck. DO NOT thread cap into hole.

e. Properly dispose of any used oil at an approved waste management facility.

Change oil

⚠ CAUTION

Change oil when the engine is warm from operation.

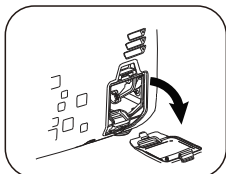

a. Place the engine on a level surface which is 300mm higher than the ground.

b. Remove the oil maintenance cover.

c. Place the waste oil box on the ground.

d. Remove the oil dipstick, and tilt the machine to pour the oil.

e. Add recommended oil to the upper limit.

f. Fully tighten the dipstick.

g. Properly dispose of any used oil at an approved waste management facility.

h. Reinstall the oil maintenance cover.

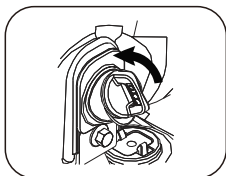

⚠ WARNING

The engine is not filled with oil at the factory. If operated before it has been properly filled with the recommended type and amount of oil may result in engine damage and void your warranty.

Air filter

- Remove the air filter cover.
- Loosen the filter clamp and remove the cover of the air filter.
- Remove the foam filter element.
- Wash in liquid detergent and warm water.
- Squeeze thoroughly dry in a clean cloth.
- Saturate in clean engine oil.
- Squeeze in a clean absorbent cloth to remove all excess oil.
- Assemble the filter element onto the filter unit.
- Assemble the filter clamp.
- Reinstall the appearance cover.

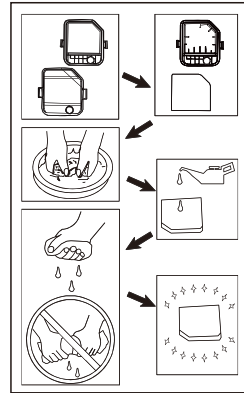

⚠ WARNING

DO NOT run the engine without the air filter, or serious damage and danger can result.

Spark plug

- Clean any dirt from the spark plug cap and spark plug base.
- Remove the spark plug cap.
- Use a socket wrench to loosen and remove the spark plug.
- Inspect the spark plug and spark plug washer, if it is broken or worn, replace with new one. Clean the spark plug with a wire brush if reusing.
- Check spark plug gap.

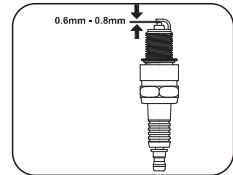

Carefully bend the side of the electrode to adjust the gap if necessary.

Spark plug gap: 0.6mm-0.8mm

- Carefully thread the plug into the engine by hand.
- After the spark plug is seated, use spark plug wrench to tighten the plug.

Spark Plug Tighten Torque: 15-20 N.m

- Attach the spark plug wire to the plug.

⚠ WARNING

Only use recommended spark plug or equivalent. DO NOT use spark plugs that have improper heat range.

Spark Arrester (Applicable types)

- a. Allow the engine to cool completely before servicing the spark arrester.
- b. Remove the muffler blind window first.
- c. Remove the spark arrester screen.
- d. Carefully remove the carbon deposits from the spark arrester screen with a wire brush.
- e. Replace the spark arrester if it is damaged.
- f. Reinstall the spark arrester in the muffler and reinstall the muffler blind window

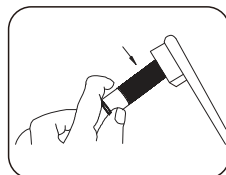

TROUBLESHOOTING

Failure	Trouble	Solution
Generator fails to start.	Two-in-one switch is in "OFF" position.	Turn two-in-one switch to the "RUN" position.
	Lack of fuel.	Fill fuel tank per instructions in this manual.
	Lack of engine oil.	Check oil level. This engine is equipped with a low oil sensor. The engine cannot be started unless the oil level is above the prescribed lower limit.
	No ignition.	Remove the spark plug cap. Clean any dirt around the plug base, and then remove the spark plug. Install the spark plug in the plug cap. Turn the two-in-one switch to "RUN" position. Grounding the electrode to any engine ground, pull the recoil starter to see if sparks jump across the gap. If there is no spark, replace the plug. Reinstall the plug and start engine according to instructions in this manual. Consult Customer Service if necessary.
	Spark plug is splashed by Fuel.	Remove the spark plug and wipe off the fuel.
	The generator cuts out after running for a certain time.	Turn the ventilation knob on the fuel tank cap to "ON" position. Check the fuel and oil level. Add them if necessary
Generator has no output.	Breaker trip.	Reset circuit breakers.
	Inadequate cord sets or extension cords.	Check cord sets or extension cords capabilities in section controls; cable size in this manual. Consult Customer Service if necessary.

STORAGE AND TRANSPORTATION

Storage

The generator should be started at least once every 2 weeks and allowed to run for at least 20 minutes. Follow the instructions below for longer term storage if the generator will be out of service for 2 months or more.

DANGER

Fire or explosion

Gasoline is highly flammable and extremely explosive. Empty the fuel tank and shut off fuel valve before storing or transporting this generator.

1. Allow the generator to cool completely before storage.
2. Turn off the fuel supply at the fuel valve.
3. Drain all fuel completely from the fuel hose and carburetor to prevent gum from forming.
4. Change the oil.
5. Remove the spark plug and pour about 15 ml of oil into the cylinder. Crank the engine slowly to distribute the oil and lubricate the cylinder.
6. Clean the generator according to the instructions in the maintenance section.
7. Store the unit in a clean, dry area out of direct sunlight.

Transportation

To prevent fuel spillage when transporting or during temporary storage, the generator should be secured upright in its normal operating position, with the engine switch OFF. The fuel valve lever should be turned OFF.

WARNING

When transporting:

Do not overfill the tank. Do not operate the generator while it is on a vehicle. Take the generator off the vehicle and use it in a well-ventilated place. Avoid a place exposed to direct sunlight when putting the generator on a vehicle. If the generator is left in an enclosed vehicle for many hours, high temperature inside the vehicle could cause fuel to vaporize resulting in a possible explosion. Do not drive on a rough road for an extended period with the generator on board. If you must transport the generator on a rough road, drain the fuel from the generator beforehand.

WIRING DIAGRAM

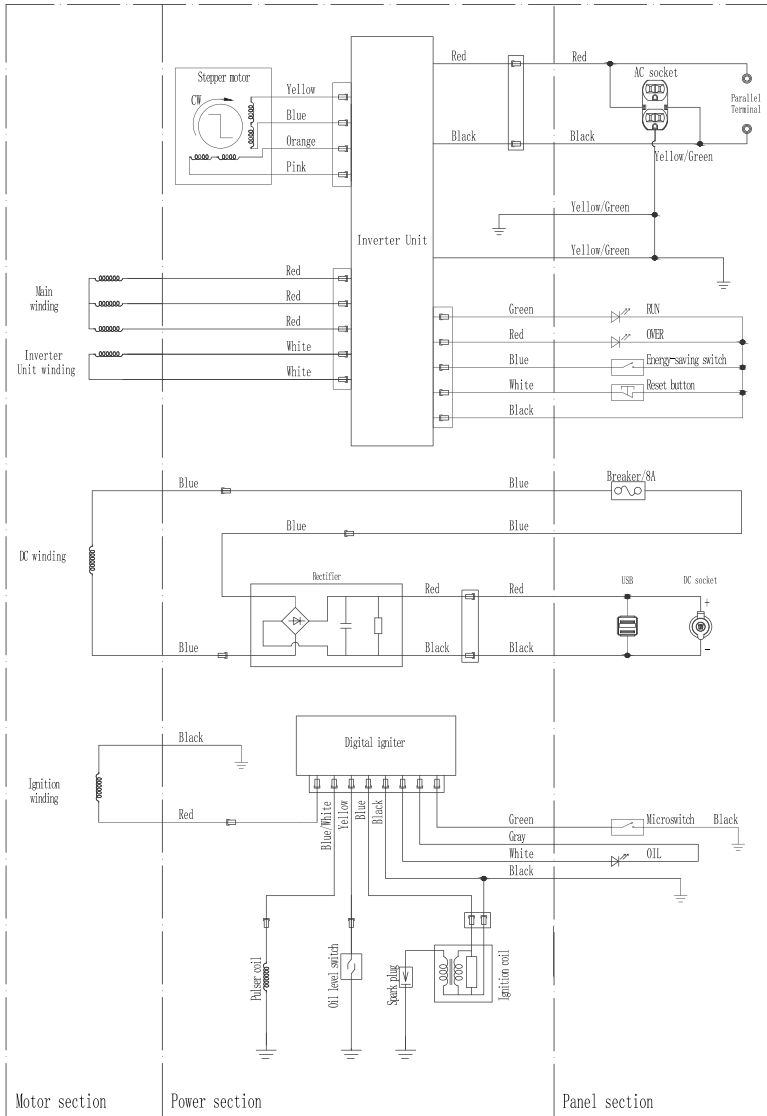

WARRANTY STATEMENTS

FEDERAL EXHAUST AND EVAPORATIVE EMISSIONS CONTROL WARRANTY STATEMENT

YOUR WARRANTY RIGHTS AND OBLIGATIONS

The United States Environmental Protection Agency (EPA), and MECANAIR INC. (MECANAIR) are pleased to explain the exhaust and evaporative emissions (“emissions”) control system’s warranty on your 2020 small off-road engine or equipment (SORE). New equipment that use small off-road engines must be designed, built, and equipped to meet the State’s stringent anti-smog standards. MECANAIR must warrant the emissions control system on your SORE for the periods of time listed below provided there has been no abuse, neglect or improper maintenance of your small off-road engine or equipment leading to the failure of the emissions control system.

Your emissions control system may include parts such as the carburetor or fuel-injection system, the ignition system, catalytic converter, fuel tanks, fuel lines (for liquid fuel and fuel vapors), fuel caps, valves, canisters, filters, clamps and other associated components. Also included may be hoses, belts, connectors, and other emission-related assemblies.

Where a warrantable condition exists, MECANAIR will repair your SORE at no cost to you including diagnosis, parts and labor.

MANUFACTURER'S WARRANTY COVERAGE:

This exhaust and evaporative emissions control system on your SORE is warranted for two years. If any emissions-related part on your SORE is defective, the part will be repaired or replaced by MECANAIR.

OWNER'S WARRANTY RESPONSIBILITIES:

As the SORE owner, you are responsible for performing the required maintenance listed in your owner's manual. MECANAIR recommends that you retain all receipts covering maintenance on your SORE, but MECANAIR cannot deny warranty coverage solely for the lack of receipts or for your failure to ensure the performance of all scheduled maintenance.

As the SORE owner, you should however be aware that MECANAIR may deny your warranty coverage if your SORE or a part has failed due to abuse, neglect, or

improper maintenance or unapproved modifications.

You are responsible for presenting your SORE to a MECANAIR distribution center or service center as soon as the problem exists. The warranty repairs shall be completed in a reasonable amount of time, not to exceed 30 days.

If you have any questions regarding your warranty rights and responsibilities, you should contact **MECANAIR INC.** at **1-866-206-0888** or at **www.mecanair.net**

DEFECTS WARRANTY REQUIREMENTS:

(a) **Applicability.** This section applies to emissions control systems on small off-road engines or equipment that use small off-road engines subject to the emission standards in this Article. The warranty period begins on the date the engine or equipment is delivered to an ultimate purchaser.

(b) **General Emissions Warranty Coverage.** The engine or equipment must be warranted to the ultimate purchaser and any subsequent owner that the emissions control system when installed was:

(1) Designed, built, and equipped so as to conform with all applicable regulations; and

(2) Free from defects in materials and workmanship that causes the failure of a warranted part for a period of two years.

(c) **The warranty on emissions-related parts will be interpreted as follows:**

(1) Any warranted part that is not scheduled for replacement as required maintenance in the written instructions furnished with each new engine or equipment must be warranted for the warranty period defined in subsection (b)(2). If any such part fails during the period of warranty coverage, it must be repaired or replaced by MECANAIR according to subsection (4) below. Any such part repaired or replaced under the warranty must be warranted for a time not less than the remaining warranty period.

(2) Any warranted part that is scheduled only for regular inspection in the written instructions furnished with each new engine or equipment must be warranted for the warranty period defined in subsection (b)(2). A statement in such written instructions to the effect of "repair or replace as necessary" shall advise owners of

the warranty coverage for emissions related parts. Replacement within the warranty period is covered by the warranty and will not reduce the period of warranty coverage. Any such part repaired or replaced under warranty must be warranted for a time not less than the remaining warranty period.

(3) Any warranted part that is scheduled for replacement as required maintenance in the written instructions furnished with each new engine or equipment must be warranted for the period of time prior to the first scheduled replacement point for that part. If the part fails prior to the first scheduled replacement, the part must be repaired or replaced by the manufacturer according to subsection (4) below. Any such part repaired or replaced under warranty must be warranted for a time not less than the remainder of the period prior to the first scheduled replacement point for the part.

(4) Repair or replacement of any warranted part under the warranty provisions of this article must be performed at no charge to the owner at a warranty station.

(5) Notwithstanding the provisions of subsection (4) above, warranty services or repairs must be provided at distribution centers that are franchised to service the subject engines or equipment.

(6) The owner must not be charged for diagnostic labor that leads to the determination that a warranted part is in fact defective, provided that such diagnostic work is performed at a warranty station.

(7) Throughout the emissions control system's warranty period set out in subsection (b)(2), MECANAIR must maintain a supply of warranted parts sufficient to meet the expected demand for such parts and must obtain additional parts if that supply is exhausted.

(8) Manufacturer-approved replacement parts that do not increase the exhaust or evaporative emissions of the engine or evaporative emission system must be used in the performance of any warranty maintenance or repairs and must be provided without charge to the owner. Such use will not reduce the warranty obligations of MECANAIR.

(9) The use of add-on or modified parts may be grounds for disallowing a warranty claim made in accordance with this Article. MECANAIR will not be liable under this Article to warrant failures of warranted parts caused by the use of an add-on or modified part.

(10) MECANAIR shall provide any documents that describe MECANAIR's warranty

procedures or policies within five working days of request by the Executive Officer.

(d) A list of all emissions warranty parts must be included with each new engine or equipment subject to this Article. The emissions warranty parts list shall include all parts whose failure would increase exhaust or evaporative emissions, and contains the following parts (if applicable):

(1) Fuel Metering System

- Carburetor and internal parts (and/or pressure regulator or fuel injection system).
- Air/fuel ratio feedback and control system.
- Cold start enrichment system.

(2) Air Induction System

- Controlled hot air intake system.
- Intake manifold.
- Air filter.

(3) Ignition System

- Spark Plugs.
- Magneto or electronic ignition system.
- Spark advance/retard system.

(4) Exhaust Gas Recirculation (EGR) System

- EGR valve body, and carburetor spacer if applicable.
- EGR rate feedback and control system.

(5) Air injection System

- Air pump or pulse valve.
- Valves affecting distribution of flow.
- Distribution manifold.

(6) Catalyst or Thermal Reactor System

- Catalytic converter.
- Thermal reactor.
- Exhaust manifold.

(7) Particulate Controls

- Traps, filters, precipitators, and any other device used to capture particulate emissions.

(8) Miscellaneous Items Used in Above Systems

- Vacuum, temperature, and time sensitive valves and switches.

- Electronic controls.
- Hoses, belts, connectors, and assemblies.
- (9) Evaporative Controls
 - Fuel Tank
 - Fuel Cap
 - Fuel Lines (for liquid fuel and fuel vapors)
 - Fuel Line Fittings
 - Clamps
 - Pressure Relief Valves
 - Control Valves
 - Control Solenoids
 - Electronic Controls
 - Vacuum Control Diaphragms
 - Control Cables
 - Control Linkages
 - Purge Valves
 - Gaskets
 - Liquid/Vapor Separator
 - Carbon Canister
 - Canister Mounting Brackets
 - Carburetor Purge Port Connector

Note: Any other warranty statements apply to engines or equipment units shall not limit the emissions warranty period (two years) or its applicability to subsequent owners after the ultimate purchaser.

WARRANTY

RADLEY PORTABLE INVERTER GENERATOR WARRANTY

If this Radley tool fails due to a defect in material or workmanship within three years from the date of purchase, return it to any Home Hardware store with the original bill of sale for exchange. This warranty does not include expendable parts including but not limited to blades, brushes, belts, light bulbs and/or batteries. This warranty covers defects in material or workmanship only. It does not cover normal wear and tear, failure due to abuse/misuse, or defects caused by careless or accidental mishandling. If this Radley product is used for commercial or rental purposes, this warranty does not apply.

PARTS SCHEMATIC

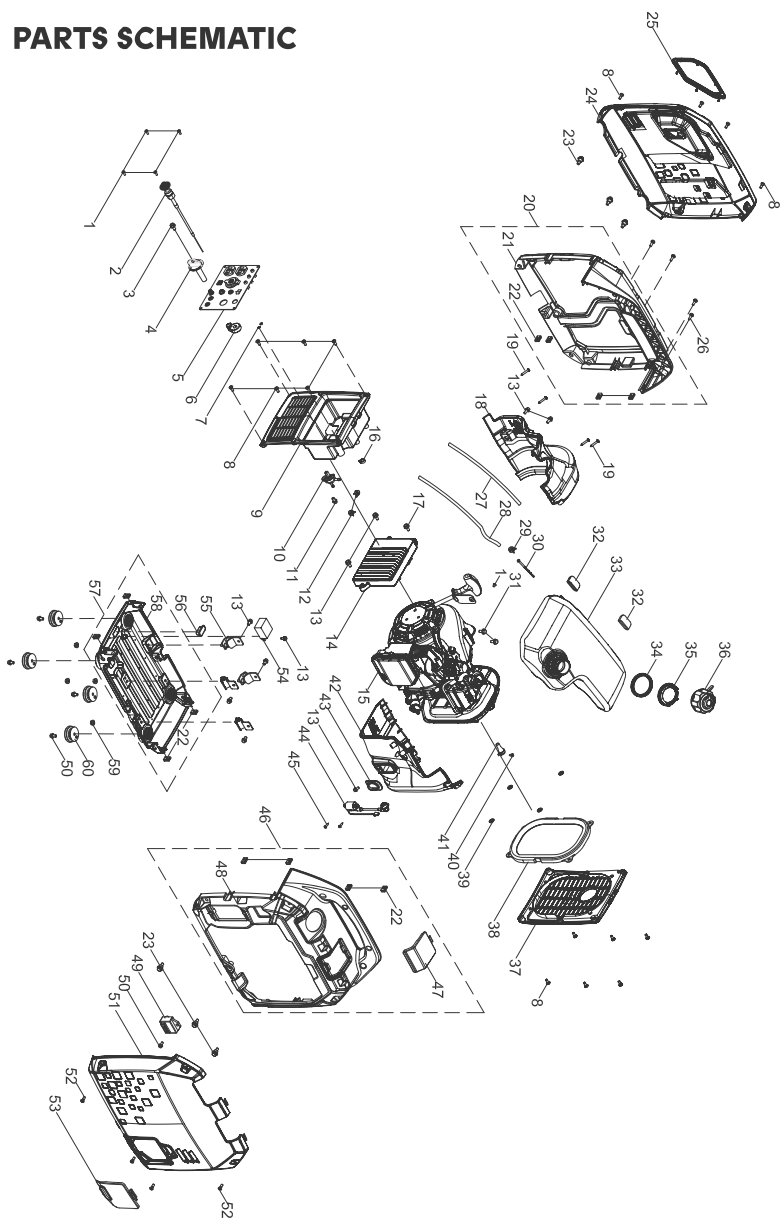

PARTS LIST

⚠ WARNING: When servicing, use only original equipment replacement parts. The use of any other parts may create a safety hazard or cause damage to the portable inverter generator.

Any attempt to repair or replace electrical parts on this portable inverter generator may create a safety hazard unless repairs are performed by a qualified technician.

Customer Service /Tech Support 1-866-206-0888.

No.	Description	Qty.
1	Screw, M4x10	5
2	Throttle Cable	1
3	Bolt, M4x18	1
4	Fuel Switch Lever	1
5	Control Panel	1
6	Main Shaft Slide	1
7	Bearing Clamp Ring	2
8	Bolt	16
9	Left Hull	1
10	Fuel Switch	1
11	Bolt, M6x14	1
12	Clamp	2
13	Bolt, M6x12	10
14	Inverter	1
15	Engine	1
16	Clip	1
17	Bolt, M5x12	1
18	Cylinder Head Baffle	1
19	Self-tapping Screw, ST4.2x25	4
20	Left Hull	1
21	Left Hull	1
22	Fuel Tank Mount Thread Tab	12
23	Alignment Bolt	6
24	Left Cover Board	1

No.	Description	Qty.
25	Appearance Protect	1
26	Screw, M5x16	4
27	Fuel Hose Jacket	1
28	Fuel Hose	1
29	Clamp	1
30	Fuel Filter	1
31	Bolt, M6x18	2
32	Damping Pad	2
33	Fuel Tank	1
34	Damping Pad	1
35	Nut	1
36	Fuel Cap	1
37	Service Window	1
38	Gasket, Muffler	1
39	Bearing Clamp Ring	5
40	Self-tapping Screw, ST4.2x9.5	1
41	Spark Arrester	1
42	Cylinder Head Baffle	1
43	O-Ring, Dipstick	1
44	Ignition Coil	1
45	Self-tapping Screw, ST4.8x20	2
46	Right Hull	1
47	Service Window	1
48	Right Hull	1

No.	Description	Qty.
49	Ignition Module	1
50	Bolt, M6x12	5
51	Right Cover Board	1
52	Phillips Bolt	4
53	Oil Window	1
54	Rectifier	1
55	Damping Pad	4
56	Damping Pad	1
57	Switch Box Base	1
58	Switch Box Base	1
59	Nut, M6	4
60	Rubber Cap	4