

# Radley®

26 cc • 2 Cycle

# Grass Trimmer



3 Year  
limited  
warranty

15" / 38cm  
cutting swath

Owner's Manual



READ ALL INSTRUCTIONS BEFORE FIRST USE.  
KEEP THIS MANUAL FOR FUTURE REFERENCE.  
KEEP AWAY FROM CHILDREN.

## PRODUCT SPECIFICATIONS

<b>2 CYCLE LAWN TRIMMER</b>	
Engine displacement	26 CC
Engine type	2-stroke
Line size	0.08" / 2 mm
Cutting swath	15" / 38 mm
Fuel tank capacity	16.9 oz / 500 mL
Fuel to oil mix ratio	50:1

**NOTE** Do not use E15 or E85 fuel (fuel containing ethanol greater than 10%) in this product. It is a violation of federal law and will damage the engine and void your warranty. FUEL MIXTURE for this product is powered by a 2-cycle engine and requires pre-mixing gasoline and 2-cycle oil in a 50:1 ratio. Pre-mix unleaded gasoline and 2-cycle engine oil in a clean container approved for gasoline. DO NOT mix quantities larger than usable in a 30-day period.

### **Need Assistance?**

Call us on our toll free customer support line:

1-833-818-4111 - Monday through Friday, 9am – 5pm, Eastern Standard Time

- Technical questions
- Replacement parts
- Parts missing from package

## TABLE OF CONTENTS

Product specifications .....	1
Table of contents .....	2
General safety warnings .....	3-5
Symbols .....	6
Operation/quick start symbols.....	7
Know your 2-cycle lawn trimmer.....	8
Included pieces .....	9
Assembly and operation.....	9-17
Handling fueling and refueling	
fuel mixutre/2-stroke oil/mixing .....	11-12
Starting the engine .....	13
Stopping the engine .....	14
Throttle operation .....	14
To extend line .....	14
Proper trimmer operations .....	15-16
General safety tips and operation .....	15
Replacing trimmer line .....	16-17
Storing and maintenance .....	17-19
General maintenance .....	17
Cleaning the air filter/fuel cap/maintenance schedule .....	18-19
Storing the lawn trimmer .....	19
Troubleshooting .....	20
Exploded view /parts list.....	21-27
Warranty .....	28

## SAFETY INSTRUCTIONS

- Do not allow children or untrained individuals to use this unit.
- Never start or run the engine inside a closed area; breathing exhaust fumes can kill.
- Always wear eye protection with side shields marked to comply with ANSI Z87.1 along with hearing protection. Failure to do so could result in objects being thrown into your eyes and other possible serious injuries.
- Keep all bystanders, children, and pets at least 50' /15.2 m away.
- Wear heavy long pants, long sleeves, boots, and gloves. Do not wear loose fitting clothing, short pants, sandals, jewelry of any kind, or go barefoot.
- Do not operate this unit when you are tired, ill, or under the influence of alcohol, drugs, or medication.
- Do not operate in poor lighting.
- Keep all parts of your body away from any moving parts and all hot surfaces of the unit.
- Wear a face filter mask in dusty conditions to reduce the risk of injury associated with the inhalation of dust.
- Check the work area before each use. Remove all objects such as rocks, broken glass, nails, wire, or string which can be thrown or become entangled in the machine.
- Keep firm footing and balance. Do not overreach. Overreaching can result in loss of balance or exposure to hot surfaces.
- Never operate the unit without a spark arrestor screen; this screen is located inside the muffler.
- Use only identical manufacturer's replacement parts and accessories.
- Use of any other parts may create a hazard or cause product damage.
- Maintain the unit per maintenance instructions in this Operator's Manual.
- Inspect the unit before each use for loose fasteners, fuel leaks, etc. Replace damaged parts.
- Do not use on a ladder, rooftop, tree, or other unstable support. Stable footing on a solid surface enables better control of the trimmer in unexpected situations.
- Before cleaning, repairing, or inspecting, shut off the engine and make certain all moving parts have stopped. Disconnect the spark plug wire and keep the wire away from the plug to prevent starting.
- Service on the trimmer must be performed by qualified repair personnel only. Service or maintenance performed by unqualified personnel could result in injury to the user or damage to the product.
- The cutting attachment should never rotate at idle during normal use. The cutting attachment may rotate at idle during carburetor adjustments.

**READ ALL INSTRUCTIONS BEFORE USING THIS 2 CYCLE LAWN TRIMMER**

- Use only as directed in this operator's manual.
- Never use blades, flailing devices, wire, or rope on trimmer attachment. Never use flailing devices, wire, or rope on any attachment.
- To reduce the risk of hearing loss associated with sound level(s), hearing protection is required.
- To reduce the risk of injury associated with contacting rotating parts, stop the engine before installing or removing attachments. Always disconnect the spark plug before performing maintenance or accessing any movable parts.
- Never run the unit without the proper equipment attached. Always ensure the grass shield is installed.
- This product is intended for infrequent use by homeowners and other occasional users for such general applications as trimming grass and edging lawns, etc. It is not intended for prolonged use. Exposure to vibrations through prolonged use of gasoline-powered hand tools could cause blood vessel or nerve damage in the fingers, hands and joints of people prone to circulation disorders or abnormal swelling. Prolonged use in cold weather has been linked to blood vessel damage in otherwise healthy people. If symptoms occur such as numbness, pain, loss of strength, change in skin color or texture, or loss of feeling in the fingers, hands or joints, discontinue use of the tool and seek medical attention. For such use, it may be appropriate to use a product having an anti-vibration feature.

### **FUEL SAFETY**

- Fuel is highly flammable. Take precautions when using to reduce the chance of serious personal injury.
- Store fuel in a cool, well-ventilated area, safely away from spark and/or flame-producing equipment.
- Store fuel in containers specifically designed for this purpose.
- Only refuel outdoors and do not smoke while refueling.
- Add fuel before starting the engine. Never remove the cap of the fuel tank or add fuel while the engine is running or when the engine is hot.
- Do not smoke while handling fuel.
- Mix and store fuel in a container approved for gasoline.
- Mix fuel outdoors where there are no sparks or flames.
- Loosen fuel cap slowly to release pressure and to keep fuel from escaping around the cap.
- Tighten the fuel cap securely after refueling.
- Wipe spilled fuel from the unit. Move 30' / 9 m away from refueling site before starting engine.
- Never attempt to burn off spilled fuel under any circumstances.
- To reduce the risk of fire and burn injury, handle fuel with care. It is highly flammable.

**SAVE THESE INSTRUCTIONS FOR REFERENCE**

- If fuel is spilled, do not attempt to start the engine but move the machine away from the area of spillage and avoid creating any source of ignition until fuel vapors have dissipated.
- Replace all fuel tank and container caps securely.
- Empty fuel tank into a container approved for gasoline and restrain the unit from moving before transporting in a vehicle.
- When draining the fuel tank, use an approved fuel storage container in a well-ventilated area.
- Select bare ground, stop engine, and allow to cool before refueling.
- Save these instructions. Refer to them frequently and use them to instruct others who may use this product. If you loan someone this tool, loan them these instructions also.

**READ ALL INSTRUCTIONS BEFORE USING THIS 2 CYCLE LAWN TRIMMER**









## SAFETY INFORMATION

### IMPORTANT

Please read these instructions fully before assembling and operating.



### SYMBOLS

The following table depicts and describes safety symbols that may appear on this product. Read, understand, and follow all instructions on the machine before attempting to assemble and operate.

	<p><b>READ THE OPERATOR'S MANUAL(S)</b> – Read, understand, and follow all instructions in the user manual before attempting to assemble and operate.</p>		<p><b>WARNING - HOT SURFACE</b> To reduce the risk of injury or damage, avoid contact with any hot surface.</p>
	<p><b>SAFETY ALERT –</b> Indicates a precaution, a warning, or a danger.</p>		<p><b>CLEARANCE</b> Keep all objects including others at least 50' / 15.2 m from this machine.</p>
	<p><b>ROTATING STRING TRIMMER HEAD</b> Keep clear of string trimmer head when engine is running. Never point the trimmer at yourself or others. Do not operate unit without proper attachments and guards in place. Stop the engine and allow the trimmer head to stop before cleaning or performing any maintenance. Never put your hand by the trimmer head when engine is running. Contact with rotating parts can cause severe injury.</p>		<p><b>TOXIC FUMES</b> The engine exhaust from this product contains chemicals known to the state of California to cause cancer and birth defects and other reproductive harm. <b>RISK OF ASPHYXIATION</b> This engine emits carbon monoxide, an odorless, colorless poisonous gas. Breathing carbon monoxide can cause nausea, fainting or death. Use only in a well ventilated area.</p>
	<p><b>EYE AND EAR PROTECTION</b> Always wear safety goggles or safety glasses with side shields, and as necessary a full face shield as well as full ear protection when operating this product.</p>		<p><b>THROWN OBJECTS</b> Beware of flying objects that could hit you.</p>
	<p><b>RISK OF FIRE/EXPLOSION</b> Fuel and its vapors are extremely flammable and explosive. Fire can cause severe burns or death. Do not add fuel while the product is operating or still hot. <b>OPEN FLAME ALERT</b> Fuel and its vapors are extremely flammable and explosive. Keep fuel away from smoking, open flames, sparks, pilot lights, heat, and other ignition sources.</p>		









### OPERATION SYMBOLS

Some of the following symbols may be used on this product. Please study them and learn their meaning. Proper interpretation of these symbols will allow you to more safely operate the product.

	<p><b>Choke</b> Move choke lever to “RUN” position. See Starting and Stopping Engine Section.</p>
	<p><b>Choke</b> Move choke lever to “CHOKE” position. See Starting and Stopping Engine Section.</p>

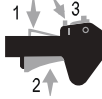
### QUICK START LABEL SYMBOLS

Some of the following symbols may be used on this product. Please study them and learn their meaning. Proper interpretation of these symbols will allow you to more safely operate the product.

	<p>Check fuel if necessary.</p>
	<p>Move choke lever to “CHOKE” position.</p>
<p>A.  B. </p>	<p>Primer bulb: A. For cold starts, press primer bulb 7-10 times. B. For warm starts, DO NOT press primer bulb.</p>
	<p>Set the throttle trigger in the starting position, using the throttle set button. To set the throttle trigger for starting, press the throttle trigger lockout (1) by gripping the control handle, pull the throttle trigger (2), then press and hold the throttle set button while releasing the throttle trigger(3).</p>
	<p>Move the ignition switch to the ON (I) position.</p>
	<p>Holding the unit firmly, pull starter handle until the engine starts.</p>
	<p>Allow the engine to warm up to idle for 30-60 seconds.</p>



## KNOW YOUR 2 CYCLE LAWN TRIMMER

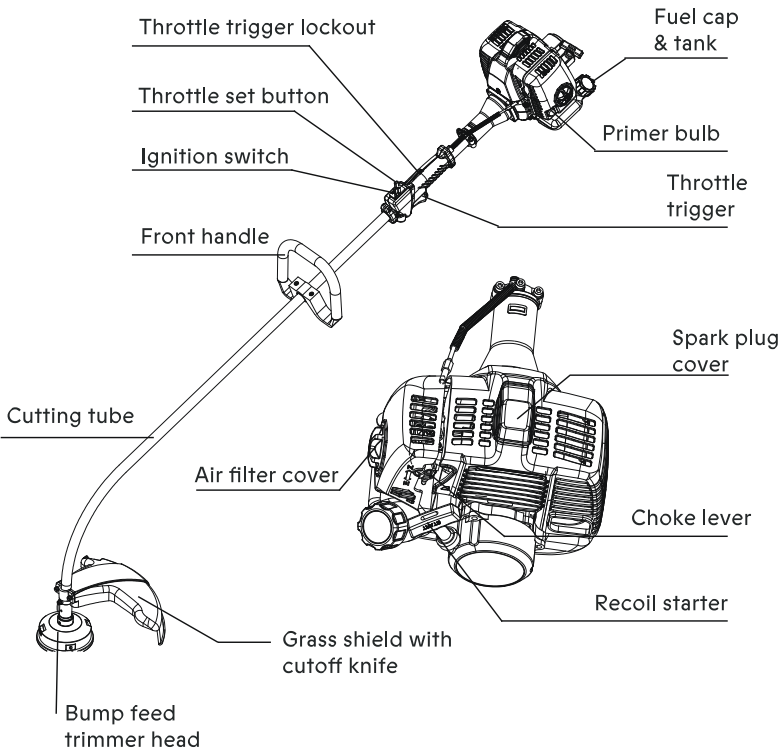

### INCLUDED PIECES

Carefully remove the lawn trimmer from its packaging and check that the following parts are included:

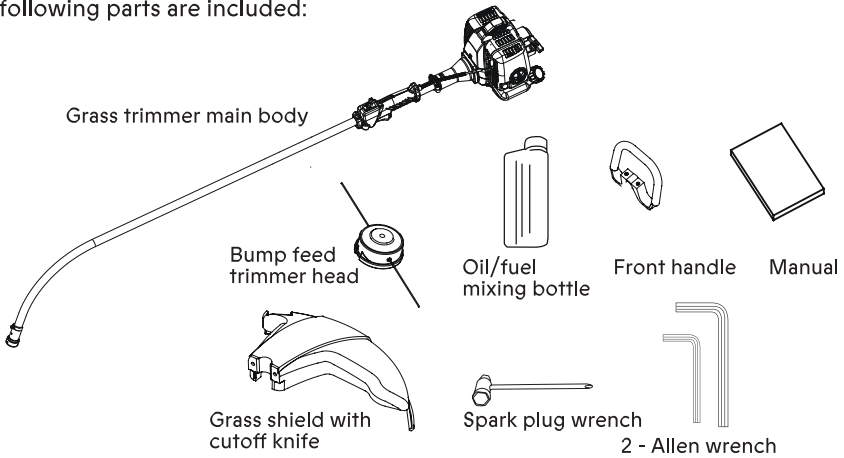

### ASSEMBLY

Your trimmer requires some assembly. If you have any questions regarding the assembly of your trimmer, call our Technical Support Team at 1-833-818-4111. Please have your serial number and model number available.

1. Attach the trimmer handle by placing both pieces of the handle around the trimmer shaft at the desired length. Fasten both pieces together by tightening the bolts clockwise with the Allen wrench provided.

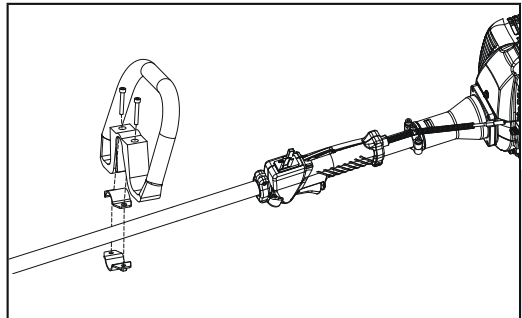

2. Install the grass shield by placing bolts through the grass shield assembly and fasten the bolts to the grass shield clockwise using the Allen wrench provided.

**⚠ NOTE!** Make sure the grass shield is assembled in line with the sleeve edge at the end of the tube.

**⚠ NOTE!** Please remove the cutoff knife cover before use.

**⚠ CAUTION :** Pay attention to the cutoff knife to prevent injury to people!

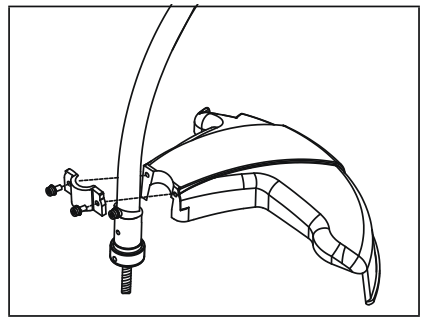

3. Assemble the trimmer head to the unit by placing the trimmer head into the trimmer assembly. Keep the assembly from spinning by placing a screwdriver or Allen wrench in the trimmer head slot. Tighten the trimmer head onto unit by rotating it clockwise.

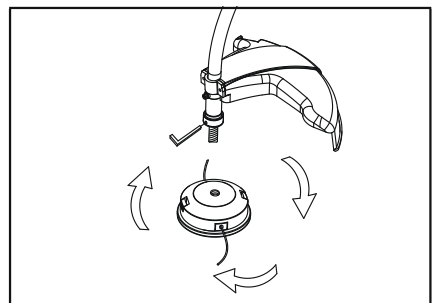

## OPERATION

### HANDLING FUELING AND REFUELING

#### FUEL MIXTURE

**⚠ CAUTION!** The machine is equipped with a two-stroke engine and must always be run using a mixture of gasoline and two-stroke engine oil. It is important to accurately measure the amount of oil to be mixed to ensure that the correct mixture is obtained. When mixing small amounts of fuel, even small inaccuracies can drastically affect the ratio of the mixture.

**⚠ WARNING:** Always ensure there is adequate ventilation when handling fuel.

#### FUEL

**⚠ CAUTION!** Always use a good quality gas/oil mixture (87 gas).

- If you run the engine on a low octane gas (lower than 87), it can result in knocking. This gives rise to a high engine temperature, which can result in serious engine damage.
- When working at continuous high revs, a higher octane is recommended.
- Gas with up to 10% ethanol is acceptable. Do not use E15 and E85 gas.

#### TWO-STROKE OIL

- For best results and performance, use good quality two-stroke oil which is intended for air cooled engines. This engine requires two-stroke oil. Mixture 1:50 (2%).
- Never use two-stroke oil intended for water-cooled outboard engines, also referred to as outboard oil.

Gas/ Litre	Two-stroke oil/litre mixture of 2% - 1:50
1	0.02
2	0.04
3	0.06
4	0.08

#### MIXING

Always mix the gasoline and oil in a clean container intended for fuel.

Always start by filling half the amount of the gasoline to be used. Then add the entire amount of oil. Mix (shake) the fuel mixture. Add the remaining amount of gasoline.

Mix (shake) the fuel mixture thoroughly before filling the machine's fuel tank.

Do not mix more than one month's supply of fuel at a time.

If the machine is not used for some time, the fuel tank should be emptied and cleaned.

**⚠ WARNING:** The catalytic converter muffler gets very hot during and after use. This also applies during idling. Be aware of the fire hazard, especially when working near flammable substances and/or vapors

## FUELING

**⚠ WARNING:** Taking the following precautions, will lessen the risk of fire:

Do not smoke or place hot objects near fuel.

Always shut off the engine before refueling.

Always stop the engine and let it cool for a few minutes before refueling.

When refueling, open the fuel cap slowly so that any excess pressure is released gently.

Tighten the fuel cap carefully after refueling.

Always move the machine away from the refueling area before starting.

1. Place the trimmer on a flat stable surface, with the fuel tank cap facing upwards.
2. Clean the surface around the fuel cap to prevent contamination.
3. Loosen the fuel cap slowly by turning counterclockwise.
4. Pour the fuel mixture carefully into the tank.
5. Only fill the fuel tank to 80% of the full capacity. Fuel level can be seen via the clear fuel tank.
6. Clean and inspect the fuel cap gasket before replacing the fuel cap.
7. Replace the fuel cap and tighten it by turning it clockwise.
8. Wipe spilled fuel from the product.
9. If you spill fuel on the unit, wait 10 minutes after wiping before starting.
10. Move at least 30' / 9 m away from refueling area before starting the product.

**⚠ NOTE:** It is normal for smoke to be emitted from a new engine during first use.

**⚠ WARNING:** Always shut off engine before fueling. Never add fuel to a machine with a running or hot engine. Wait at least 15 minutes to allow for cool down before refueling. Move at least 30' / 9m from refueling site before starting engine. Do not smoke and stay away from open flames and sparks. Failure to safely handle fuel could result in serious personal injury.

**⚠ NOTICE:** Do not use E15 or E85 fuel (fuel containing ethanol greater than 10%) in this product. It is federal violation and will damage your engine and void your warranty.

**⚠ NOTICE:** Gasoline containing up to 10% ethanol by volume (commonly referred to as E10) is acceptable. E15 and E85 are not.

### OPERATION

#### STARTING THE ENGINE

1. To start a cold engine, move the choke lever to the CLOSED position. To restart a warm engine, leave the choke lever in the OPEN position.
2. To start a cold engine, or after refueling an engine that has run out of fuel, press the primer bulb 7-10 times. To restart a warm engine, it is not necessary to press the primer bulb.
3. Set the throttle trigger in the starting position, using the throttle set button. To set the throttle trigger for starting, press the throttle trigger lockout by gripping the control handle, pull the throttle trigger, then press and hold the throttle set button while releasing the throttle trigger.
4. Move the ignition switch to the ON (I) position.
5. Set the trimmer on the ground, resting on the grass shield and the fuel tank guard. Do not allow the bump feed trimmer to contact any obstruction. Always rest the trimmer on the ground for starting, rather than holding it in the operating position. This prevents the end of the trimmer from swinging into something as you start the engine.
6. With your left hand, hold the control handle just ahead of the engine. With your right hand, pull the recoil starter lightly until you feel resistance, then pull briskly. Return the recoil starter gently.
7. If the choke lever was moved to the CLOSED position to start the engine, gradually move it to the OPEN position as the engine warms up. Allow the engine to warm up for at least 30-60 seconds after a cold start. When the engine is warm enough to idle well, pull and release the throttle trigger to disengage the throttle set button. The bump feed trimmer head should not rotate with the engine idling. If there is rotation at idle, adjust the idle speed correctly before using the trimmer. For idle adjustment, consult your authorized servicing dealer.

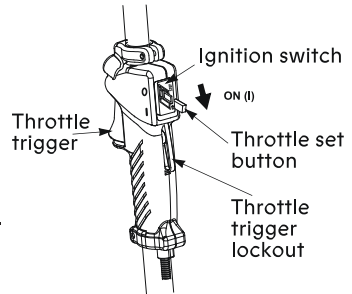
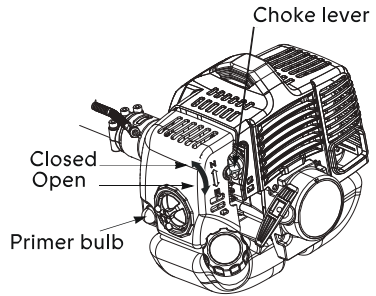

### STOPPING THE ENGINE

1. Release the throttle trigger.
  2. Move the ignition switch to the STOP (O) position.
- Wait for the bump feed trimmer head to stop before allowing the end of the trimmer to contact anything.

**⚠ WARNING!** Maintain proper control of the trimmer until the bump feed trimmer head has completely stopped rotating.

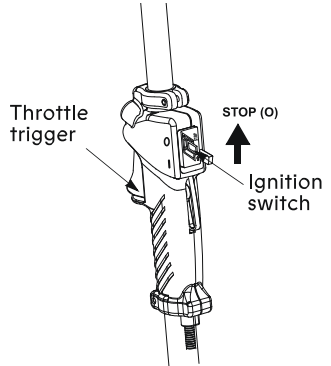

### THROTTLE OPERATION

Pull the throttle trigger toward the control handle to increase engine speed and start the cutting attachment rotation.

The trimmer has the greatest cutting force at maximum engine speed.

Release the throttle trigger to reduce engine speed. At idle, the cutting attachment should coast to a stop.

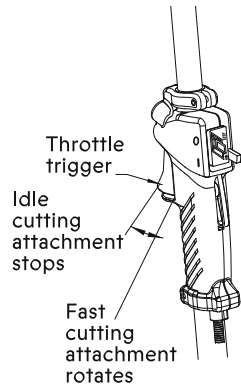

### TO EXTEND LINE

This unit features a bump feed trimmer head. If the cutting swath has decreased due to wear or breaking, firmly bump the bump feed on the trimmer head on the ground to extend the line.

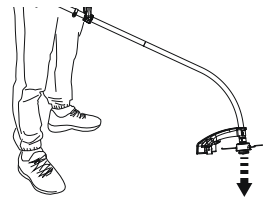

## **PROPER TRIMMER OPERATION**

### **SAFETY:**

Fully familiarize yourself with the IMPORTANT SAFETY INSTRUCTIONS section. Check your equipment before operation, especially the string head, grass shield, muffler, air intakes, and air filters.

Use only recommended or equivalent replacement line in the cutting head. Do not use any other cutting attachment. To install any other type of replacement line or cutting head to this string trimmer can result in serious personal injury.

### **OPERATION**

Assemble the grass trimmer. Refer to the ASSEMBLY section earlier in this manual.

Start the trimmer. Refer to Starting and Stopping earlier in this manual.

Maintain a firm grip on both handles while trimming. Hold the trimmer with your right hand on the throttle and your left hand on the front handle. Keep string head below waist level. Never cut with the string head located over 15"/38.1 cm or more above the ground.

Move the trimmer slowly along outer edge of grass or vegetation to be trimmed.

Cut tall grass from the top down. This will prevent grass from wrapping around the shaft housing and string head which could cause damage from overheating. If grass becomes wrapped around the string head, STOP THE ENGINE, disconnect the spark plug wire, and remove the grass. Prolonged cutting at partial throttle will result in lubricant dripping from the muffler.

### **GENERAL TIPS**

To reduce sound levels, limit the number of pieces of equipment used at any one time.

Keep the trimmer tilted toward the area being cut.

Use the edge of line to do the cutting; do not force the string head into uncut grass.

Fencing, posts, rocks and other items can cause extra wear and possibly breakage of the trimmer line. Take extra care when cutting around these items as they can be damaged by the string.

The curved shaft trimmer cuts when passing the unit from right to left. This will avoid throwing debris at the operator.



**⚠ WARNING!** Always hold the string trimmer away from the body keeping clearance between the body and the product. Any contact with the housing or string trimmer cutting head can result in burns and/or other serious personal injury.

**⚠ WARNING!** Always position the unit on the operator's right side. The use of the unit on the operator's left side will expose the user to hot surfaces and can result in possible burn injury. Any contact with the housing can result in burns and/or other serious personal injury.

**⚠ WARNING!** Never use blades, flailing devices, wire, or rope on this product. Do not use any attachments or accessories not recommended by the manufacturer of this product. The use of attachments or accessories not recommended can result in serious personal injury.

Operate power equipment at reasonable hours only - not early in the morning or late at night when people might be disturbed. Comply with the times listed in local ordinances.

**⚠ WARNING!** Always wear eye protection with side shields marked to comply with ANSI Z87.1, along with hearing protection. Failure to do so could result in objects being thrown into your eyes and other possible serious injuries.

## REPLACING TRIMMER LINE

1. Place the provided Allen wrench or a screwdriver into the cut out on the trimmer head to prevent the assembly from moving.
2. Rotate the head counterclockwise to remove the trimmer head.

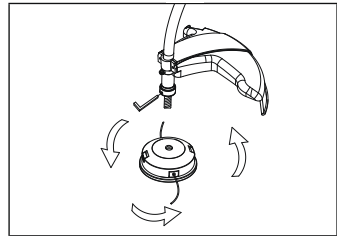

3. Remove the string holder by pressing both tabs as shown at right.

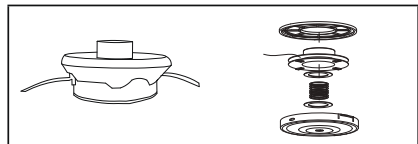

4. Make sure the replacement line is 0.08" / 2 mm line. Fold the replacement string line in half and connect to the spool. Rotate the string around the spool in the direction indicated by the arrows on the spool.

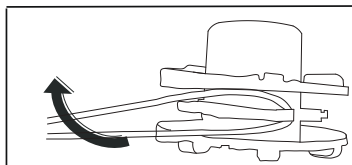

**NOTE:** Fold the replacement string line as direction shown "RH WIND LINE" instead of the opposite direction.

5. Lock the string into the opposite detents leaving about 5" / 120mm on each side.

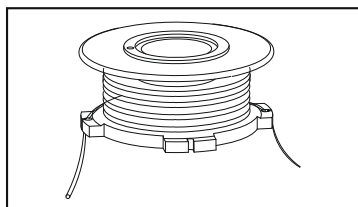

6. Thread the remaining string through the holes on the string trimmer head assembly.
7. Assemble the bump head to the unit by rotating clockwise and adjust the string length as needed.

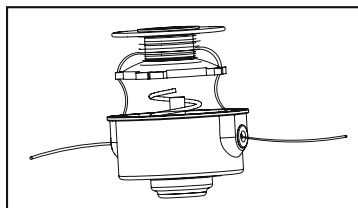

## MAINTENANCE

### GENERAL MAINTENANCE

Avoid using solvents when cleaning plastic parts. Most plastics are susceptible to damage from various types of commercial solvents and may be damaged by their use. Use a clean cloth to remove dirt, dust, lubricant, grease, etc..

**⚠ WARNING!** Before inspecting, cleaning, or servicing the machine, shut off engine, wait for all moving parts to stop, and disconnect spark plug wire and move it away from spark plug. Failure to follow these instructions could result in personal injury or property damage.

**⚠ WARNING!** When servicing, use only identical replacement parts. Use of any other parts could create a hazard or cause product damage.

**⚠ WARNING!** Do not at any time let brake fluids, gasoline, petroleum based products, penetrating oils, etc., come in contact with plastic parts. Chemicals can damage, weaken, or destroy plastic which could result in serious personal injury.

**⚠ WARNING!** Tampering or adjusting the factory set carburetor is a Federal Violation and will void your warranty coverage.

### CLEANING THE AIR FILTER

For proper performance and long life, keep the air filter clean.

1. Move choke knob to CHOKE position (See Start section of manual) to prevent dirt and debris from entering carburetor.
2. Remove the air cleaner cover by turning the cover fastener counterclockwise. Brush away any accumulated dirt from the air filter cover area.

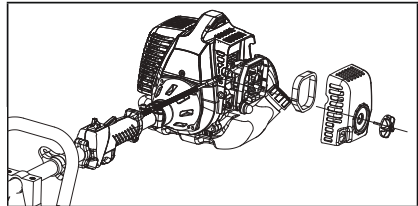

3. Inspect and clean the air filter. To reassemble make sure the filter fits in the cavity and reinstall the filter as shown. Fasten the air filter cover by turning the fasteners clockwise.

### FUEL CAP

**⚠ WARNING!** Check for fuel leaks. A leaking fuel cap is a fire hazard and must be replaced immediately. If you find any leaks, correct the problem before using the product. Failure to do so could result in a fire that could cause serious personal injury.

### SPARK PLUG

1. Remove spark plug and check for worn and rounded center electrode.
2. Clean, adjust or replace with a new spark plug per gap specifications below.

OEM type	CHAMPION RCJ6Y
Replacement type	NGK CMR6A
Gap	0.024" - 0.028"/0.6-0.7 MM

### MAINTENANCE SCHEDULE

Follow the service intervals indicated in the following schedule. Service your trimmer more frequently when operating in adverse conditions. Contact our help line authorized service dealer. Time intervals shown are maximum. Actual use and your experience will determine the frequency of required maintenance.

### BEFORE USE

- Wipe up fuel leaks, fuel spillage.
- Inspect and clean fuel tank.
- Inspect grass shield and trimmer head.

**EVERY 25 HOURS**

- Clean cylinder fins and intake cooling vent.
- Inspect and clean the air filter.

**EVERY 50 HOURS**

- Clean and readjust spark plug gap (gap: 0.6 - 0.7 mm/0.024 - 0.028"), and replace if necessary.
- Clean exhaust port.
- Inspect and clean the air filter.

**ANNUALLY**

- Replace spark plug.

**STORING THE TRIMMER**

Clean all foreign material from the product. Store idle unit indoors in a dry, well-ventilated area that is inaccessible to children. Keep away from corrosive agents such as garden chemicals and deicing salts.

Abide by all ISO and local regulations for the safe storage and handling of gasoline.

**WHEN STORING 1 MONTH OR LESS:**

Fuel stabilizer is an acceptable alternative in minimizing the formation of fuel gum deposits during storage. Add stabilizer to your fuel container (not the fuel tank on the trimmer). Run engine at least 3 minutes after adding stabilizer.

**WHEN STORING MORE THAN A MONTH:**

Drain all fuel from tank into a container approved for gasoline. Run engine until it stops.

## TROUBLESHOOTING

PROBLEM	POSSIBLE CAUSE	SOLUTION
Engine does not start.	Fuel mixture is too rich. Fuel strainer clogged. Fuel line clogged. Flooded engine. Spark plug gap is incorrect.	Open choke. Clean fuel strainer. Clean fuel line. Let unit sit for 15 minutes or remove spark plug and clean per manual. Replace or adjust spark plug per instructions.
Engine dies or accelerates poorly.	Air filter is dirty. Incorrect fuel. Exhaust port / spark arrestor screen blocked.	Clean air filter. Drain and fill with correct fuel/new fuel. Clean exhaust port/spark arrestor screen.
Spool retainer is hard to turn.	Screw threads are dirty or damaged.	Clean threads and lubricate with grease - if no improvement, replace the spool retainer.
Grass wraps around drive shaft housing and string head.	Cutting tall grass at ground level. Operating trimmer at part throttle.	Cut tall grass from the top down to prevent wrapping. Operate trimmer at full throttle.

### EXPLODED PARTS

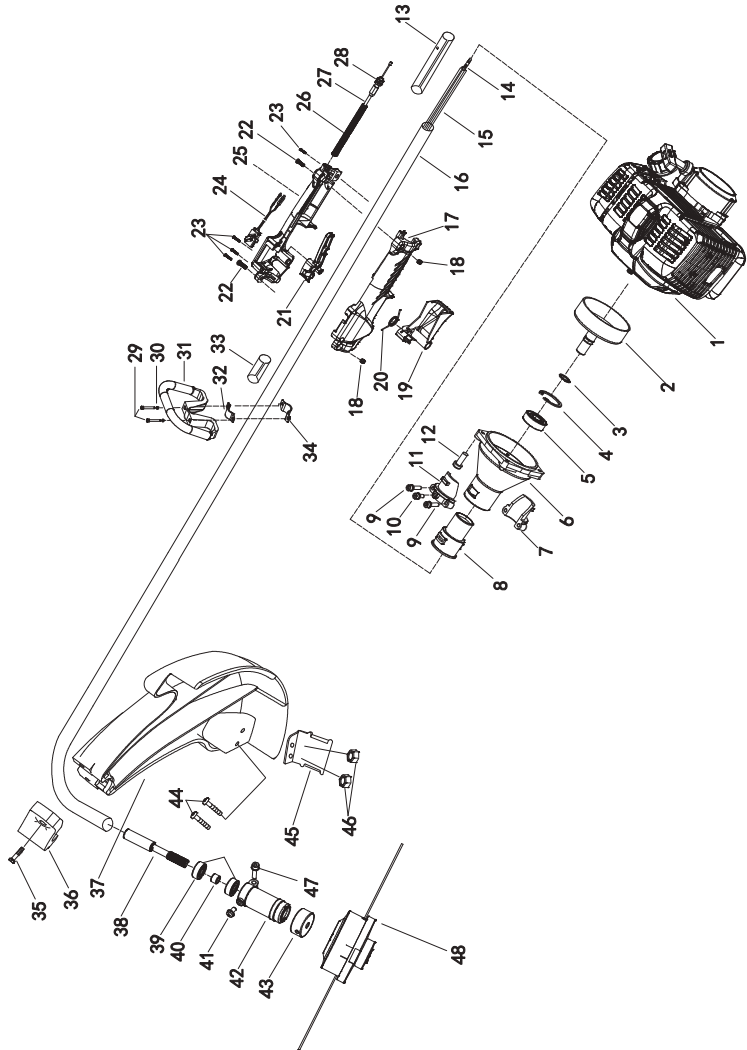

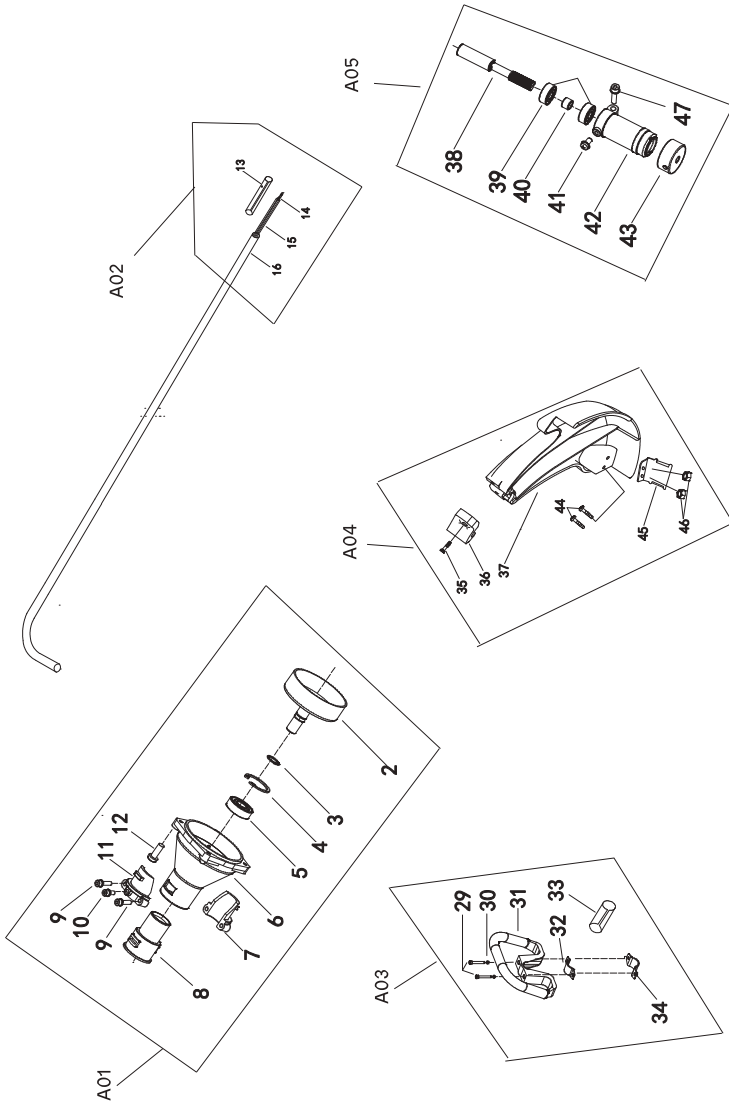

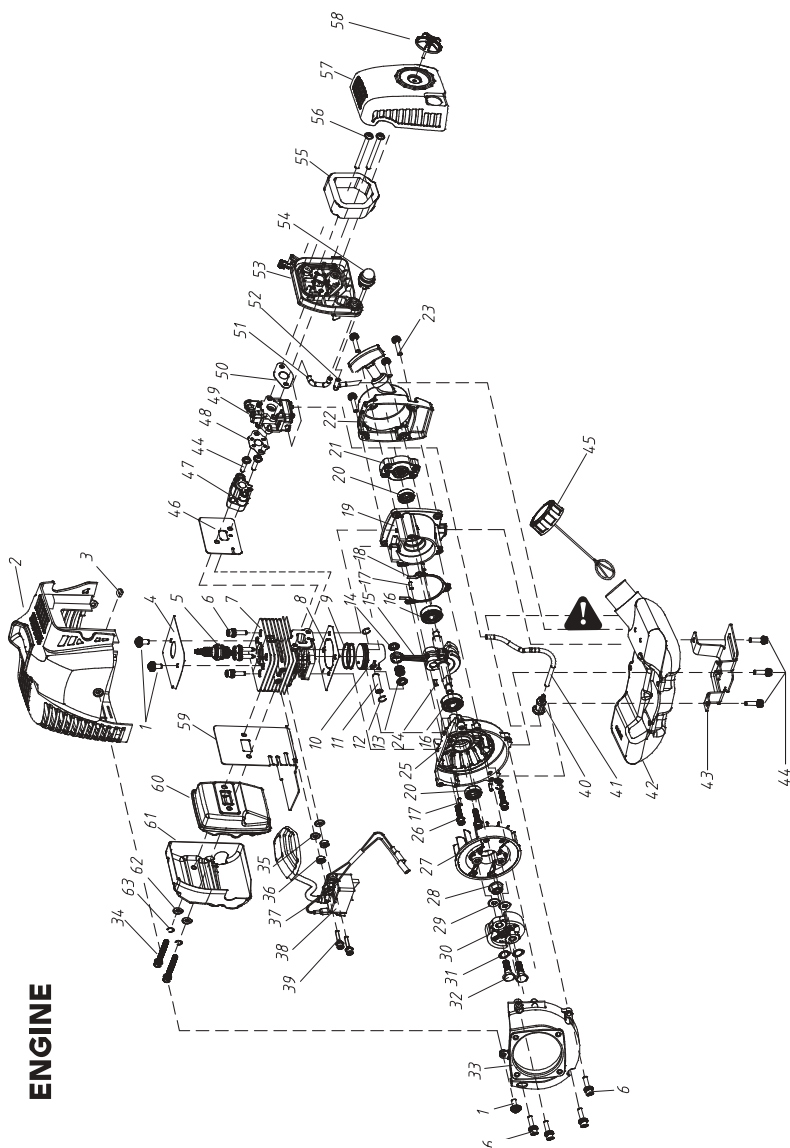

## ENGINE



## PARTS LIST

**⚠ WARNING:** When servicing, use only original equipment replacement parts. The use of any other parts may create a safety hazard or cause damage to the lawn trimmer.

Any attempt to repair or replace parts on this lawn trimmer may create a safety hazard unless repairs are performed by a qualified technician. For more information, call the Toll-free Helpline, at 1-833-818-4111, Monday – Friday, from 9am to 5pm, Eastern Standard Time.

Number	Part sku	Part Name	Quantity
1	APCA021001	Semi-finished engine	1
2	APCA021002	Clutch drum	1
3	APCA021003	Retaining ring	1
4	APCA021004	Retaining ring	1
5	APCA021005	Ball bearing	1
6	APCA021006	Connector pad	1
7	APCA021007	Lower fixing plate	1
8	APCA021008	Rubber cover dia.26	1
9	APCA021009	Inner hexagon screw assembly	2
10	APCA021010	Inner hexagon screw assembly	1
11	APCA021011	Upper fixing plate	1
12	APCA021012	Inner hexagon screw assembly	4
13	APCA021013	Cushion cover	1
14	APCA021014	Flexible shaft assembly	1
15	APCA021015	Plastic support	1
16	APCA021016	Aluminum tube	1
17	APCA021017	Box, left	1
18	APCA021018	Prevailing torque type hexagon nut	2
19	APCA021019	Handgrip	1
20	APCA021020	Spring	1
21	APCA021021	Handgrip	1
22	APCA021022	Screw	2
23	APCA021023	Self-tapping screw	4
24	APCA021024	Stop switch assembly	1
25	APCA021025	Box, right	1
26	APCA021026	Threaded pipe 8x12x210	1
27	APCA021027	Cable	1
28	APCA021028	Hexagon thin nut	2
29	APCA021029	Screw	2
30	APCA021030	Spacer	2
31	APCA021031	Handle	1
32	APCA021032	Handle platen	1
33	APCA021033	Handle cushion cover	1
34	APCA021034	Lower handle platen	1

Number	Part sku	Part Name	Quantity
35	APCA021035	Inner hexagon screw assembly	2
36	APCA021036	Cover of cutter guard	1
37	APCA021037	Cutter guard	1
38	APCA021038	Transmission shaft-connector	2
39	APCA021039	Ball bearing	1
40	APCA021040	Spacer sleeve	2
41	APCA021041	Screw M5x12	1
42	APCA021042	Aluminum connector	2
43	APCA021043	Strain relief	1
44	APCA021044	Screw M5x12	1
45	APCA021045	Small blade	1
46	APCA021046	Prevailing torque type hexagon nut	1
47	APCA021047	Bolt assembly	1
48	APCA021048	String head assembly	1
A01	APCA021049	Connector pad assembly	1
A02	APCA021050	Aluminum tube assembly	1
A03	APCA021051	Handle assembly	1
A04	APCA021052	Cutter guard assembly	1
A05	APCA021053	Connector assembly	1
Engine			1
1	APCA021054	Bolt assembly M5x12	3
2	APCA021055	Engine cover	1
3	APCA021056	Fixing sleeve	1
4	APCA021057	Baffle	1
5	APCA021058	Spark plug RCJ6Y	1
6	APCA021059	Inner hexagon screw assembly M5x20	8
7	APCA021060	Cylinder	1
8	APCA021061	Cylinder gasket	1
9	APCA021062	Piston ring	2
10	APCA021063	Piston	1
11	APCA021064	Piston pin 8x28	1
12	APCA021065	Ring-piston pin	2
13	APCA021066	Needle bearing 8x11x9	1
14	APCA021067	Thrust washer	2
15	APCA021068	Crankshaft assembly	1
16	APCA021069	Bearing 6001/P53	2
17	APCA021070	Bearing pin B3x10	4
18	APCA021071	Gasket-cover	1
19	APCA021072	Rear crankcase	1
20	APCA021073	Oil seal 12x22x7	2
21	APCA021074	Starter bowl assembly	1
22	APCA021075	Starter assembly	1

Number	Part sku	Part Name	Quantity
23	APCA021076	Bolt assembly M5x16	4
24	APCA021077	Woodruff key 3x3.7x12	1
25	APCA021078	Front crankcase	1
26	APCA021079	Inner hexagon screw assembly M5x30	3
27	APCA021080	Flywheel	1
28	APCA021081	Nut M8x1	1
29	APCA021082	Flat washer 6x15x12	2
30	APCA021083	Clutch assembly	1
31	APCA021084	Wave washer	2
32	APCA021085	Bolt shaft	2
33	APCA021086	Flywheel cover	1
34	APCA021087	Inner hexagon screw M5x50	2
35	APCA021088	Spacer 4	2
36	APCA021089	Gasket-muffler	2
37	APCA021090	Engine stop wire	1
38	APCA021091	Coil comp	1
39	APCA021092	Bolt assembly M4x20	2
40	APCA021093	Fuel filter	1
41	APCA021094	Fuel pipe	1
42	APCA021095	Fuel tank	1
43	APCA021096	Fuel tank support	1
44	APCA021097	Bolt assembly M5x20	5
45	APCA021098	Fuel tank cap assembly	1
46	APCA021099	Insulator gasket	1
47	APCA021100	Boot-intake	1
48	APCA021101	Carburetor gasket	8
49	APCA021102	Carburetor	1
50	APCA021103	Air filter base gasket	1
51	APCA021104	Fuel pipe	1
52	APCA021105	Fuel pipe	1
53	APCA021106	Air filter inner cover assembly	1
54	APCA021107	Grease squirt	1
55	APCA021108	Air filter core	1
56	APCA021109	Bolt assembly M5x60	2
57	APCA021110	Air filter cover	1
58	APCA021111	Knob	1
59	APCA021112	Muffler gasket	1
60	APCA021113	Muffler assembly	1
61	APCA021114	Muffler guard	1
62	APCA021115	Spring washer 5	2
63	APCA02116	Flat washer 5	2

## **WARRANTY**

### **RADLEY 2 CYCLE LAWN TRIMMER WARRANTY**

If this Radley tool fails due to a defect in material or workmanship within three years from the date of purchase, it has a three-year repair warranty with the original bill of sale. This warranty does not include expendable parts including but not limited to blades, brushes, belts, light bulbs and/or batteries. This warranty covers defects in material or workmanship only. It does not cover normal wear and tear, failure due to abuse/misuse, or defects caused by careless or accidental mishandling. If this Radley product is used for commercial or rental purposes, this warranty does not apply.



26 cc • 2 Cycle

# Grass Trimmer



3 Year  
limited  
warranty

15" / 38cm  
cutting swath  
Owner's Manual



Radley

EXCLUSIVE TO HOME HARDWARE

For information on the entire line up of Radley power  
tools visit [homehardware.ca](http://homehardware.ca) or your local Home Hardware retail store.

MADE IN CHINA / FABRIQUÉ EN CHINE  
HOME HARDWARE STORES LIMITED  
ST. JACQUES, ONTARIO M0G 2N0  
ORDER ONLINE / COMMANDE EN LIGNE  
[homehardware.ca](http://homehardware.ca)

© 10, 2010 Home Hardware Stores Limited



5074-006