

BENCHMARKTM MC

12" CORDLESS BRUSHLESS 20V MAX* LAWN TRIMMER



Item # 5073-100



5 Year Limited Warranty on tool
3 Year Limited Warranty on battery and charger



E114847
JD5516-BL

**READ ALL INSTRUCTIONS BEFORE FIRST USE.
KEEP THIS MANUAL FOR FUTURE REFERENCE.
KEEP AWAY FROM CHILDREN.
SEE NEXT PAGE FOR CRITICAL TOOL RELATED
PRECAUTIONS**

*Maximum initial battery voltage (measured without a load) is 20 volts.
Normal voltage is 18 volts.



**WEAR CSA APPROVED
EYE PROTECTION**



**WEAR EAR
PROTECTION**



**WEAR A
FACE MASK**

PRODUCT SPECIFICATIONS

GRASS TRIMMER

Head speed	7,200 RPM (no load)
Head type	Dual line automatic feed system
Trimmer line	Use only 0.065"
Cutting swath	12" (maximum)
Pivoting trimmer head	90°
Tool operating weight	6.68LBS (3.03KG)

BATTERY AND CHARGER

Battery voltage	20V 2.5 Ah Li-ion (Maximum charged battery voltage, measured without load, is 20V with a nominal value of 18V)
Charge time	Up to 75 minutes

REPLACEMENT PARTS AVAILABLE AT HOME HARDWARE

Replacement battery	HH #5350-023 (2.5Ah) HH #5350-011 (4Ah)
Replacement charger	HH #5350-010 (2.4A) HH #5350-022 (6A Fast)
Replacement trim line	HH #5073-103
Replacement spool cap cover:	HH #5073-104

CRITICAL TOOL RELATED PRECAUTIONS

1. Ensure grass is not blocking motor vents during and after each use. Blocked vents will result in tool damage or failure.
2. Use only 0.065" size trimmer line with this tool. The use of any other size will result in damage to tool and could result in injury to user.
3. Batteries must be fully charged before first use and must be charged/stored indoors in a cool dry environment. Exposure to temperature extremes will reduce battery performance and lifespan.

READ ALL SAFETY, WARNING, PRECAUTIONS AND MAINTENANCE INFORMATION PROVIDED IN THIS MANUAL.

NEED ASSISTANCE?

Call us on our toll-free customer support line:
1-866-349-8665 (Monday through Friday 9am – 5pm Eastern Standard Time)

- Technical questions
- Replacement parts
- Parts missing from package

TABLE OF CONTENTS

PRODUCT SPECIFICATIONS	1
TABLE OF CONTENTS	2
GENERAL SAFETY WARNINGS	3-7
SPECIFIC SAFETY RULES	7-11
BATTERY & CHARGER SAFETY.....	11-12
BATTERY PACK RECYCLING.....	12
SYMBOLS	13
KNOW YOUR LAWN TRIMMER	14
ASSEMBLY AND OPERATING.....	15-24
MAINTENANCE	25
EXPLODED VIEW.....	26
PARTS LIST	27-28
WARRANTY	29

GENERAL SAFETY WARNINGS

IMPORTANT SAFETY INSTRUCTIONS

READ AND UNDERSTAND ALL SAFETY AND OPERATIONAL INSTRUCTIONS.





Failure to follow the safety rules listed below and other basic safety precautions may result in serious personal injury. KEEP THIS MANUAL, SALES RECEIPTS AND APPLICABLE WARRANTY FORMS FOR FUTURE REFERENCE.







This instruction manual includes the following:





- General Safety Warnings
- Specific Safety Rules and Symbols
- Functional Description
- Assembly
- Operation
- Maintenance

Safety Symbols

The purpose of safety symbols is to alert you of the potential safety RISKS. Recognize and understand them. Follow the instructions provided.

 SYMBOL	MEANING
 DANGER	Failure to obey a DANGER safety alert WILL result in serious personal injury or death to you or to others. Always obey all messages following this symbol to reduce the risk of serious personal injury or death.
 WARNING	Failure to obey a WARNING safety alert MAY result in serious personal injury or death to you or to others. Always obey all messages following this symbol to reduce the risk of potential serious personal injury or death.
 CAUTION	Failure to obey a CAUTION safety alert MAY result in personal injury or property damage to you or to others. Always obey all messages following this symbol to reduce the risk of personal injury or property damage.

SYMBOL	MEANING
<p>NOTICE</p> <p>CAUTION</p>	<p>Failure to obey a NOTICE or a CAUTION (without a safety alert) MAY result in property damage to you or to others. Always obey all messages following this symbol to reduce the risk of property damage.</p>
<p>⚠ DANGER</p>  	<p>ALWAYS WEAR EYE PROTECTION THAT CONFORMS WITH CSA Z94.3 or ANSI SAFETY STANDARD Z87.1</p> <p>FLYING DEBRIS can cause permanent eye damage. Prescription eyeglasses ARE NOT a replacement for proper eye protection. The usage of a safety standard compliant face shield placed over proper safety glasses or goggles can reduce the risk of facial injury.</p> <p>Noncompliant eyewear can cause serious injury if broken during the operation of a power tool.</p>
<p>⚠ WARNING</p> 	<p>Use hearing protection, particularly during extended periods of operation of the tool, or if the operation is noisy.</p>
<p>⚠ WARNING</p> 	<p>WEAR A DUST MASK THAT IS DESIGNED TO BE USED WHEN OPERATING A POWER TOOL IN A DUSTY ENVIRONMENT.</p>
<p>⚠ WARNING</p>   	<p>Always wear nonslip gloves that fit properly to protect your hands and to help you grip the tool.</p> <p>Always wear sturdy clothing with long sleeves and long pants. Never operate the tool while wearing shorts, short sleeve shirts or shirtless.</p> <p>Always wear nonslip safety boots to prevent foot injuries and slipping that could cause loss of control of the tool.</p>

SYMBOL	MEANING
	<p>To avoid electrical hazards, fire hazards or damage to the tool, use proper circuit protection.</p>
	<p>This tool is wired at the factory for 120 V AC operations. It must be connected to a 120 V AC, 15 A circuit that is protected by a time-delayed fuse or circuit breaker. To avoid shock or fire, replace power cord immediately if it is worn, cut or damaged in any way.</p>
 	<p>WARNING: Ventilation openings in batteries and chargers must always be open to allow cooling air to circulate freely. Air vents that are blocked, restricted or covered may result in the battery or charger overheating. Overheating may lead to damage to the tool or cause a fire, resulting in possible serious injury.</p>

ELECTRIC GARDENING TOOL SAFETY

GENERAL SAFETY WARNINGS

WARNING: Read all safety warnings and all instructions. Failure to follow the warnings and instructions may result in electric shock, fire and/or serious injury.

Save all warnings and instructions for future reference.

General Electric Gardening Tool Safety Warnings – Work Area Safety

Do not operate power tools in explosive atmospheres, such as in the presence of flammable liquids, gases or dust. Power tools create sparks which may ignite the liquids, fumes or dust.

Keep children and bystanders away while operating a power tool. Distractions can cause you to lose control.

General Electric Gardening Tool Safety Warnings – Electrical Safety

Battery charger plugs must match the outlet. Never modify the plug in any way. Do not use any adapter plugs with earthed (grounded) chargers. Unmodified plugs and matching outlets will reduce risk of electric shock.

Avoid body contact with earthed or grounded surfaces such as water pipes. There is an increased risk of electrical shock if your body is earthed or grounded.

Do not expose power tools, battery chargers or batteries to rain or wet conditions. Water entering the tool, chargers or batteries will increase the risk of electric shock.

Do not abuse the cord. Never use the power cord for carrying, pulling or unplugging the charger. Keep the power cord away from heat, oil, sharp edges, and moving parts. Damaged or entangled cords increase the risk of electric shock.

When operating the charger outdoors, use an extension cord suitable for outdoor use. Use of a cord suitable for outdoor use reduces the risk of electric shock.

Never operate a power tool in the rain.

If operating a charger in a damp location is unavoidable, use a residual current device (RCD) protected supply. An RCD is also known as a ground fault circuit interrupter (GFCI) or earth leakage circuit breaker (ELCB). Use of an RCD reduces the risk of electric shock.

General Electric Gardening Tool Safety Warnings – Personal Safety

Stay alert, be aware of your surroundings, watch what you are doing and use your best judgment when operating a power tool. Do not use a power tool while you are tired or under the influence of drugs, alcohol, or medication. A moment of inattention while operating a power tool may result in serious personal injury.

Use personal protective equipment. Always wear eye protection. Protective equipment such as a dust mask, non-skid safety shoes or boots, sturdy gloves, durable long pants, long sleeve shirt and hearing protection will reduce the risk of personal injuries.

Prevent unintentional starting. Ensure the switches are in the off-position before connecting the battery to the power tool or plugging it into the power supply. Never pick up or carry the power tool with your finger on the trigger switch. Carrying power tools with your finger on the switch or energizing power tools that have the switch on invite accidents.

Remove any adjustment key or wrench before turning the power tool on. A wrench or a key left attached to a rotating part of the power tool may result in personal injury.

Do not overreach. Keep proper footing and balance at all times. This enables better control of the power tool in unexpected situations.

Dress properly. Do not wear loose clothing or jewellery. Keep your hair, clothing and gloves away from moving parts. Loose clothing, jewellery or long hair can be caught in moving parts.

Do not force the tool. Use the correct tool for the application. The correct power tool will do the job better and safer when used at the rate for which it was designed.

Do not use a power tool if the switch does not turn it on or off. Any power tool that cannot be controlled using the switch is dangerous and must be repaired.

Remove the battery from the power tool or the plug from the power source before making any adjustments, replacing or repairing parts, cleaning the tool, leaving the tool idle or unattended, transporting or storing the tool. Such preventive safety measures reduce the risk of starting the power tool accidentally.

Store idle power tools out of the reach of children and do not allow persons unfamiliar with the power tool or these instructions to operate the power tool. Power tools are dangerous in the hands of untrained users.

Maintain power tools. Check for misalignment or binding of moving parts, breakage of parts and any other condition that may affect the power tool's operation. If damaged, have the power tool repaired before use. Many accidents are caused by poorly maintained power tools.

Use the power tool and accessories in accordance with these instructions, taking into account the working conditions and the work to be performed. Use of the power tool for operations different from those intended could result in a hazardous situation.

General Electric Gardening Tool Safety Warnings – Service

Have your power tool or charger serviced by a qualified repair person using only identical replacement parts. This will ensure that the safety of the power tool or charger is maintained.

SPECIFIC SAFETY RULES

⚠ WARNING: Some dust created by power sanding, sawing, grinding, drilling, and other construction activities contain chemicals known to cause cancer, birth defects, or other reproductive harm. Some samples of these chemicals are:

- lead from lead-based paints
- crystalline silica from bricks and cement and other masonry products
- arsenic and chromium from chemically-treated lumber

Your risk from these exposures varies, depending on how often you do this type of work. To reduce your exposure to these chemicals: work in a well-ventilated area, and work with approved safety equipment, such as those dust masks that are specially designed to filter out microscopic particles.



WARNING: Know your grass trimmer. Do not plug in the charger or install the battery onto the tool until you have read and understand this instruction manual. Learn the tool's applications and limitations, as well as the general and specific potential hazards related to this tool. Following these instructions will reduce the risk of electric shock, fire or serious injury.



WARNING: Always wear appropriate eye protection. Any power tool can throw foreign objects into your eyes and cause permanent eye damage. ALWAYS wear appropriate safety goggles or properly fitted safety glasses that comply with the most recent version of ANSI Z87.1 safety standards. Ordinary vision or sunglasses generally do not provide adequate impact or side shield / wrap around penetration protection. Ordinary glasses ARE NOT safety glasses. To reduce the risk of injury to your face you should also wear a face shield over your safety goggles or safety glasses.



WARNING: Glasses, goggles or face shields not in compliance with ANSI Z87.1 or CAN/CSA – Z94.3 could cause serious injury if they break upon impact.



WARNING: Prevent foot injuries! Never operate when barefoot, or wearing open toed shoes, or sandals. Always wear sturdy protective shoes or boots with nonslip soles when operating the grass trimmer. Steel-toed safety boots are recommended.



WARNING: Protect your hands by wearing heavy-duty, nonslip gloves and to improve your grip and control when handling the grass trimmer.

Cover as much of your body as possible to help protect you from debris and pieces of toxic and allergenic plants being thrown by the grass trimmer.



WARNING: Use hearing protection. Use hearing protection such as ear plugs or ear muffers to protect your hearing, particularly if the trimmer is used for extensive periods or if the surrounding environment of operation exposes the operator to loud noises. When wearing hearing protection, you will have impaired ability to hear alarms, warnings and shouts from approaching people or approaching vehicles. Be extra diligent and observant of hazards and bystanders when wearing hearing protection devices. When someone approaches, turn the trimmer OFF immediately.



WARNING: Never use fixed blades or metal saw blades with this trimmer. Serious injury may result. Never use wire or metal-reinforced line or other material in place of the polymer trimmer line. Pieces of wire or metal reinforced line can break off and can be thrown with great force striking against and injuring the operator or bystanders.



WARNING: The rotating trimmer line and trimmer head will throw objects and debris violently and the objects and debris will ricochet in all directions. You or bystanders can be blinded or injured. Keep children, bystanders, pets and other animals at least 50 feet (15 meters) away from the operating trimmer. Turn the trimmer OFF immediately if approached, or if you are approaching such bystanders. Bystanders should be encouraged to wear eye protection, even if they are kept at a distance. The debris shield on the trimmer is designed to reduce the danger. The debris shield provided with your trimmer may not protect the operator or bystanders from all objects or debris thrown by the rotating polymer line or trimmer head.

Thrown objects may also ricochet and strike the operator or bystander. Utilize extra caution, when the trimmer is being used as an edger or sweeper, especially near, or on paved or hard surfaces, as pieces of metal, concrete, brick, stones, gravel, sand, glass, sticks and other objects can be thrown at high speed and force by the rotating line and such objects can be thrown, skip along or ricochet long distances off of hard surfaces. Do not use this trimmer for sweeping debris that may contain hard objects, e.g. pebbles, stones, sticks, glass, metal, etc. as such hard objects can be thrown with great force and cause injury to the operator or bystanders, and / or damage property, e.g., screens, windows, building siding, glass doors, or vehicles.

NOTE: Avoid operating the trimmer near property that can be easily damaged by thrown or ricocheting objects such as screens, windows, building siding, glass doors and vehicles.



WARNING: To reduce the risk of ricochet / rebound injury, or property damage, work by going away from any nearby solid object such as wall, steps, large stones, tree, etc. Use great care when working close to solid objects. Where hazardous conditions warrant, do not use the power tool, rather do trimming, edging, mowing or sweeping by hand.



WARNING: Inspect the area to be trimmed for hazards before each use. Remove any foreign objects such as sticks, rocks, broken glass, nails, wire, tools, toys, etc. which can be thrown by or become entangled in the trimmer line. Always locate, and then avoid cutting near electrical power lines, power conduit, or extension power cords. Avoid contacting hard objects with the trimmer head as the objects can damage the trimmer head and / or the objects can be thrown causing serious injury.

Use this trimmer only for trimming, scalping, mowing of grass and weeds, and for light edging of lawns, and for sweeping of only light lawn debris on paved areas. Do not use this trimmer for brush cutting, pruning or hedge trimming. Never use this trimmer on gravel or sandy areas.



! WARNING: To reduce the potential of serious injury, cut only from your right toward your left. Cutting on the right side of the guard and moving directionally towards your right will cause the debris and objects to be thrown predominately away from the operator thereby reducing the risk of personal injury to the operator, although the risk of injury due to ricochet is not lessened. Whereas cutting on the left-side of the guard or moving directionally towards your left will cause for comparatively more debris to be thrown towards the operator thereby increasing the risk of personal injury.

Hold the trimmer firmly with both hands to ensure proper control. Never operate the trimmer with one hand.

Keep the trimmer head below waist level and away from all parts of your body. Do not draw the trimmer head towards your feet or legs.

! WARNING: Always remove the battery pack when making adjustments, changing accessories, replacing the trimmer line, removing or untangling debris, leaving the tool idle or unattended, cleaning, servicing, storing or transporting the tool. Such preventive measures reduce the risk of starting the tool accidentally and causing serious injury.

Never use the trimmer with the guard removed, damaged or incorrectly positioned. Serious injury may result.

Maintain firm footing and balance at all times. Do not overreach or use the trimmer from unstable surfaces such as ladders, trees, steep slopes, slippery surfaces, rooftops, etc.

Use only in daylight or in good quality artificial light.

Inspect the trimmer head before each use. If any parts are worn or damaged, replace them before using the trimmer.

Only use the 0.065" line size for the trimmer. Use of any other type could result in serious injury.

Never use the trimmer for anything other than its intended purpose. Use for anything other than trimming grass and weeds can be dangerous. It may also damage the trimmer.

! WARNING: Dust created by use of this product may contain chemicals known to the State of California and medical experts to cause cancer, respiratory injuries, birth defects or other reproductive harm. Some examples of these chemicals are:

- Compounds in fertilizers
- Compounds in insecticides, herbicides and pesticides
- Arsenic and chromium from chemically treated lumber.
- Commercial and household chemicals.

To reduce your exposure to these chemicals, wear approved safety equipment such as dust and / or vapor masks that are specifically designed to filter out microscopic particles or gaseous components. Additionally, dust created by these products may contain allergens, bacteria and viruses, PM 10 and / or PM 2.5 particulates, exposure to such hazardous airborne matter can be reduced by wearing approved safety equipment such as dust masks that are specifically designed to filter out the microscopic particles.

⚠ WARNING: Breathing asbestos or dust with silica in its composition may contain hazardous crystalline silica. Silica is a fundamental component of sand, quartz, brick, clays, granite and many other materials and rocks, including masonry, concrete and cement products. Such crystalline silica dust is dangerous and must be avoided, as it can cause severe or fatal respiratory illness or cancer.

BATTERY & CHARGER SAFETY

⚠ WARNING: Only use the diagnostic charger supplied with this kit to charge the 20V Li-ion battery. Charging any other batteries may damage the charger and possibly cause serious injury.

Do not store or carry the battery in a manner in which metal objects could contact the exposed metal end. Do not place the battery in aprons, pockets, drawers, etc. with loose nails, screws, keys etc. The battery could short circuit causing a fire, personal injury or damage to the battery.

Never attempt to open the battery for any reason. If the housing of the battery breaks or cracks, immediately discontinue use and do not recharge.

Do not charge the battery if it is wet or shows any evidence of corrosion.

A small leakage from the battery may occur under extreme usage, charging or temperature conditions. This does not indicate a failure. However, if the outer seal is broken and this leakage gets on your skin, follow these steps:

1. Wash immediately with soap and water.
2. Neutralize with a mild acid such as lemon juice or vinegar.
3. If liquid gets into your eyes, flush immediately with clean water for a minimum of 10 minutes and seek medical attention.

NOTE: The battery liquid is slightly acidic.

Do not incinerate the battery. It can explode in a fire.

Do not use an extension cord. Plug the charging cord directly into an electrical outlet.

Use the charger only in a standard 120V, 60 Hz electrical outlet.

Do not use the charger in wet or damp conditions. It is intended for indoor use only. Do not use the charger near sinks or tubs. Do not immerse the charger in water.

Do not allow the cord to hang over the edge of a table or counter or touch hot surfaces. The charger should be placed away from sinks and hot surfaces.

12" CORDLESS BRUSHLESS 20V MAX* LAWN TRIMMER **5073-100**

Do not use the charger to charge any batteries other than the grass trimmer batteries. Other batteries may explode.

Do not operate charger if the cord or plug is damaged. Replace the damaged cord and plug immediately.

Do not operate the charger if it has received a sharp blow, been dropped or otherwise damaged in any way. Have a qualified technician examine the charger and repair it if necessary. Do not disassemble the charger.

Do NOT charge the batteries when the work area or the battery temperature is at or below 41°F / 5°C or above 105°F / 40.5°C.

Unplug the charger when not in use and before cleaning or maintenance.

BATTERY PACK RECYCLING







To preserve our natural resources, please recycle or dispose of batteries properly.

The batteries charged by this charger may contain chemicals and metals that are harmful to the environment. Never dispose of rechargeable batteries in your normal household garbage or in landfill sites as they will add to the pollution of the environment.

SYMBOLS

⚠ WARNING: Some of the following symbols may appear on the grass trimmer. Study these symbols and learn their meaning. Proper interpretation of these symbols will allow for more efficient and safer operation of this tool.

V	Volts
A	Amperes
Hz	Hertz
W	Watts
H	Hours
---	Direct current
	Alternating or direct current
	Warning symbol
	Shock hazard
	Striking hazard
	Keep bystanders back at least 50' (15m)

	Read the manual
	Wear safety glasses
	Wear safety goggles
	Wear full-face shield
	Wear hearing protection
	Wear breathing protection
	Wear safety gloves
	Wear safety boots
	No fixed blades
	No saw blades
	Risk of fire



E114847
JD5516-BL

This symbol designates that this tool is listed with U.S. requirements by MET Testing Laboratories, Inc. Conforms to UL 82. Certified to CSA C22.2 No.147:15.

KNOW YOUR LAWN TRIMMER

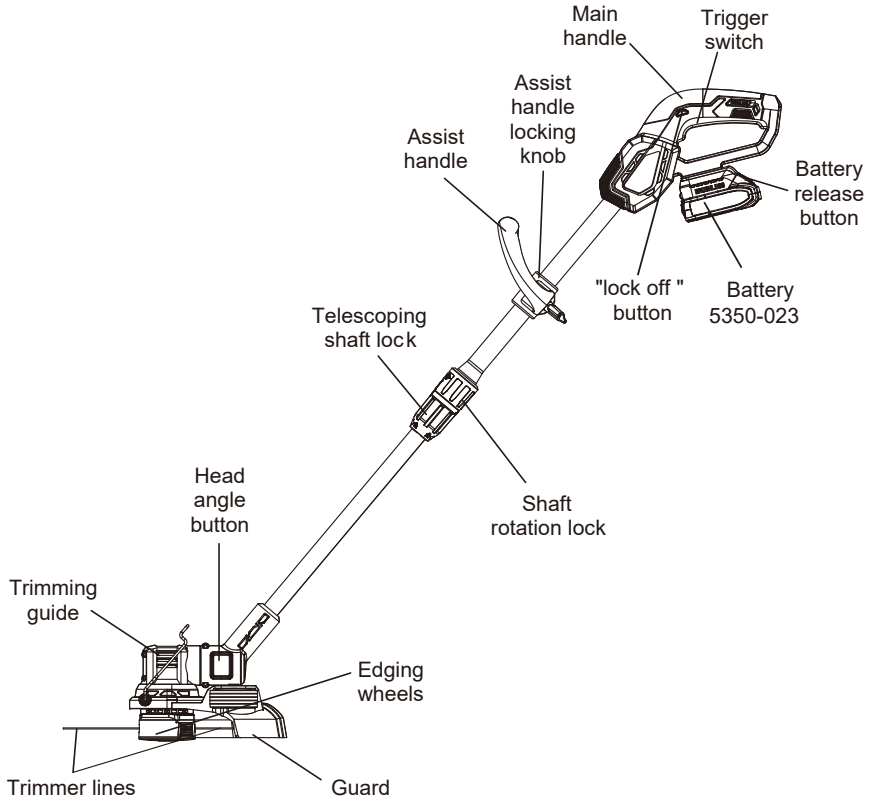

ASSEMBLY AND OPERATING

CHECKING THE BATTERY CHARGER STATUS

The level of charge remaining in the battery can be checked by using the battery LED power indicator that is contained on the end of the battery.

NOTE: The battery charge remaining may be checked while the battery is installed in the tool with the ON/OFF switch turned OFF. It may also be checked while the battery is removed from the tool. **DO NOT** check the battery charge remaining while the battery is in the charger. You will get a false reading and you may also damage the battery status system.

1. Press and hold the battery status button located on the end of the battery.
2. One or more of the Four LED lights in the LED window will come ON to indicate the amount of charge that is remaining in the battery as follows:

Charge Level Indicator						
Amount of Charge Remaining	0 - 10%	10 - 25%	25 - 50%	50 - 75%	75 - 100%	

3. Release the battery status button to turn the LEDs OFF.

CHARGING THE BATTERY PACK

1. Place the battery charger (1) in a dry location near a 110–120V 60 Hz
2. Plug the battery charger into the outlet and make sure the green LED indicator light (5) comes ON. If it does not, refer to the chart (Fig. 2) to identify the problem.
3. Turn the battery (2) upside down and slide it onto the charger.

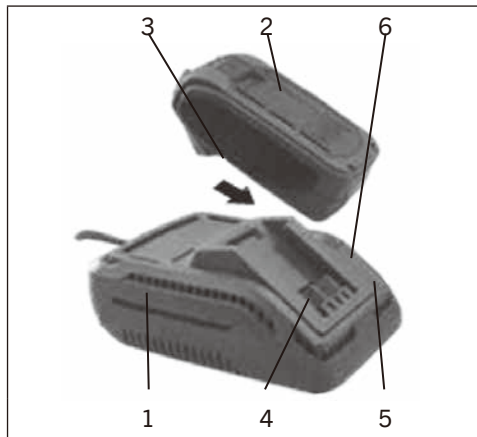

FIG. 1

- NOTE:** a) When the charger is plugged into the wall receptacle and NO battery is on the charger, the green indicator light (5) will turn ON indicating the charger is “live”.
- b) When a discharged battery is installed on the charger, the green indicator light will turn OFF and the red indicator light (6) will FLASH. The flashing red indicator light indicates the battery is being charged.
- c) If the red indicator light does not come ON, check to make sure battery pack is slid fully onto the charger and the electrical outlet is working properly.
- d) See Fig. 2 below for other indicator light functions.
- e) A discharged battery pack should be fully charged in up to 75 minutes.
- f) It is normal for the battery charger to hum and be warm to the touch during operation.
- g) If the battery pack does not charge properly, check to make sure the electrical outlet is “live”.
- h) Do NOT charge batteries when the work area or the battery temperature is at or below 5°C (41° F) or above 40°C (105° F).





GREEN LIGHT	RED LIGHT	BATTERY INSERTED INTO CHARGER	SYMBOL	CHARGING STATUS
ON	OFF	NO	NONE	CHARGER CONNECTED TO POWER SUPPLY
OFF	FLASHING	YES		BATTERY BEING CHARGED
ON	OFF	YES		BATTERY FULLY CHARGED
OFF	ON	YES		DEFECTIVE-BATTERY IS CHARGED BUT NOT OPERATIONAL ON TOOL
ON	ON	YES		CHARGING CONDITIONS ARE EITHER TOO HOT OR TOO COLD

FIG. 2

INSTALLING A BATTERY ON THE GRASS TRIMMER

1. Remove the discharged battery pack (1) from the tool by pressing the battery release button (2) on the rear of the battery downward (Fig. 3) and pulling the battery pack out of the tool handle (3) (Fig. 4).
2. Insert the fully charged battery pack into the matching slots in the rear of the tool handle where the discharged battery pack has been removed.

NOTE: The battery release button will “click” into place when the battery pack is fully installed.

⚠ WARNING: Do not immerse battery pack in water. Sudden cooling could cause a hot battery to explode or leak.

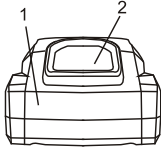

Fig. 3

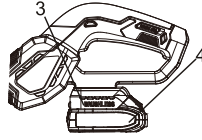

Fig. 4

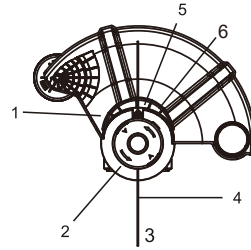

Fig. 5

INSTALLING THE GUARD

⚠ WARNING: The guard must be installed before installing the battery pack in the tool. Serious injury may result if the tool is turned ON without the guard in place.

1. Place the tool on its back on a clean work surface (Fig. 5).

2. Slide the guard in the direction as indicated by the arrow (2).

NOTE: Make sure the trimmer lines are not trapped between the guard mount and the guard.

3. Install 1 screw (4) into the matching holes (5) in the motor housing.

4. Tighten screw using a #2 Screwdriver. ⊕

NOTE: Do not over tighten the screws. You will strip the threads in the motor housing.

ADJUSTING THE ASSIST HANDLE

The assist handle mounting bracket can be slid up or down the telescoping tube, rotated from side to side or tilted forward or backward to place the assist handle in the most comfortable position. Turn locking lever(1) (Fig.6) before adjusting the assist handle position and retighten it to lock the assist handle in the new position.

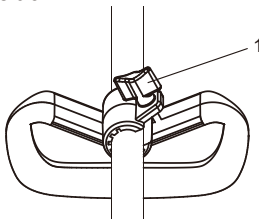

Fig. 6

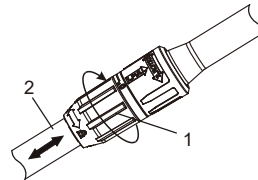

Fig. 7

ADJUSTING THE TELESCOPING SHAFT

The telescoping shaft length can be adjusted to suit the height of the person operating the tool.

1. Rotate the telescoping shaft locking collar (1) clockwise one turn (Fig. 7).

2. Slide the lower section of the telescoping shaft (2) in or out until the desired shaft length is achieved.

NOTE: The shaft length can be adjusted approximately 12" (30.5 cm).

3. Turn the locking collar counterclockwise to lock the telescoping shaft at the desired length.

NOTE: Hand tighten the locking collar.

SETTING THE TRIMMING GUIDE

The trimming guide is used to protect the trimmer line when trimming close to objects such as fence posts, fences, decks etc.

To position the trimming guide (1), simply pull it down to its horizontal position (2) (Fig. 8). When the trimming guide is not being used, it should be placed in its upright position.

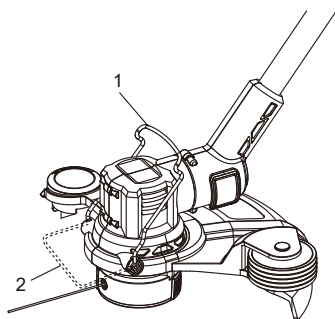

Fig. 8

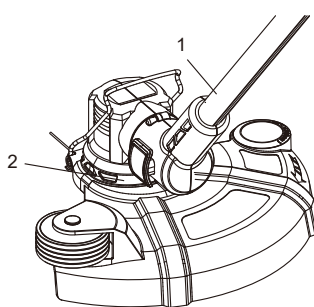

Fig. 9

ROTATING THE TRIMMER HEAD FOR EDGING

The trimmer head must be rotated to the vertical position for edging as follows:

1. Grasp the telescoping shaft (1) with one hand (Fig. 9).
2. Press the button labeled "Press for Edging" (2) to rotate the trimmer head to vertical position automatically as (Fig. 10).

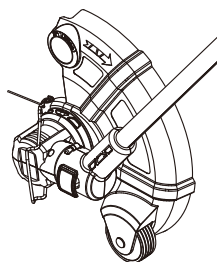

Fig. 10

LINE TRIMMING KNIFE

It is important to limit the length of the trimming lines that are exposed outside the trimmer spool. The line trimming knife will automatically cut the exposed line at the correct length to produce both efficient cutting action and to provide the longest battery life. The motor may overheat if line release is attempted in tall grass.

LOCK-OFF AND TRIGGER SWITCHES

The grass trimmer is equipped with both a lock-off and trigger switch. To turn the grass trimmer ON:

1. Press the lock-off switch (1) (Fig. 11).
2. While continuing to press the lock-off switch, squeeze the trigger switch (2).
3. When the grass trimmer starts, release the lock-off switch while continuing to squeeze the trigger switch. The grass trimmer will continue to run.
4. To turn the grass trimmer OFF, release the trigger switch.

NOTE: To restart the grass trimmer, press the lock-off switch and squeeze the trigger switch.

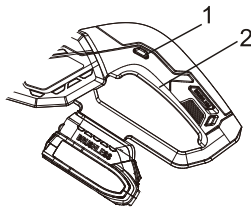

Fig. 11

REPLACING THE TRIMMER LINE SPOOL

⚠ WARNING: Remove the battery from the tool before attempting to replace the trimmer line spool.

As the trimmer is used, the line will automatically be dispensed from the spool. In time, the line supply within the spool will be depleted, making it necessary to replace the spool with a new prewound spool.

REMOVING THE OLD SPOOL

1. Press the spool locking buttons (1) into the spool housing (2) (Fig. 12).
NOTE: There are two spool locking buttons located on opposite sides of the spool housing.
2. While pressing both spool locking buttons, pull the spool cap (3) out of the spool housing (Fig. 13).
3. Pull the empty spool (4) upward to remove the spool and any remaining trimmer line from the spool housing (Fig. 14).
4. Once the empty spool has been removed from the spool housing, use a soft brush to remove any debris from the spool housing.

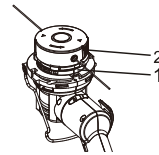

Fig. 12

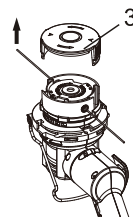

Fig. 13

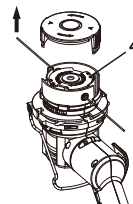

Fig. 14

INSTALLING THE REPLACEMENT SPOOL

1. Remove all packaging from the replacement spool.
NOTE: There may be shrink wrap holding the trimmer line in place on the replacement spool. This must be removed, but be sure to hold the line in place with your fingers to prevent it from unwinding from the spool.
2. Pull the loose end of the trimmer line out of the retaining slot (5) in the spool (Fig. 15).
NOTE: Be sure to hold the line in place with your fingers to prevent it from unwinding from the spool.
3. Unwind approximately 5" (12.7 cm) of line from the spool before threading the loose line through the holes in the spool housing.
4. Thread the loose end of the trimmer line (6) through the holes (7) in the spool housing (2).
5. While holding and pulling slightly on the loose line, slide the spool onto the housing spindle (8) as far as it will go.
6. Once the replacement spool is fully inserted into the spool housing, replace the spool cap (3) by inserting the locking buttons (1) into the spool housing.
7. Press the spool cap fully into the spool housing until the locking buttons "click" into the matching holes (9) in the spool housing.
NOTE: If the spool cap locking buttons do not "click" into place, check to make sure there is no debris in the spool housing that is preventing the spool cover from properly locking into place. The spool will become dislodged from the spool housing if not properly locked in place.

8. When the new trimmer line spool is installed, approximately 3" (7.6 cm) of trimmer line should be exposed beyond the spool housing. If they are too long, cut lines to length with scissors. If they are too short, press the line release button (1) on the trimmer line housing and gently pull on the exposed trimmer lines (Fig. 16).

NOTE: Each time you press the line release button it will release approximately ½" (13 mm) of line from the spool.

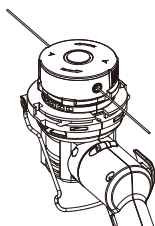

Fig. 16

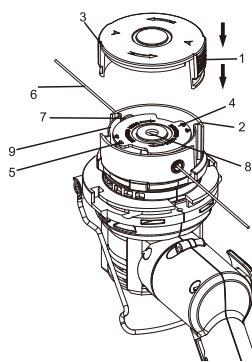
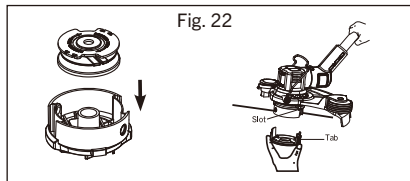
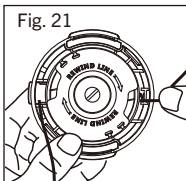
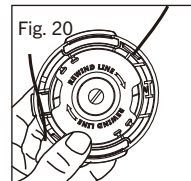
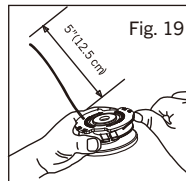
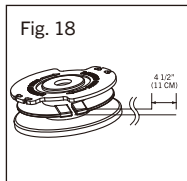
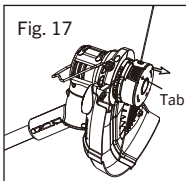

Fig. 15

MANUALLY INSTALLING AND WINDING NEW LINE ON SPOOL

1. Remove all packaging from the replacement spool. **NOTE:** There may be shrink wrap holding the trimmer line in place on the replacement spool, This must be removed, but be sure to hold the line in place with your fingers to prevent it from unwinding from the spool.
2. Press the two release tabs on the spool base and remove the spool retainer by pulling it straight out (Fig. 17).
3. Remove the spool. Use a clean cloth to clean the inner surfaces of the spool retainer and spool base.
4. Check the spool retainer, spool, and spool base for worm parts.
5. Take approximately 15'(4.5 m) of 0.08"(2.0 mm) diameter cutting line. Fold the line in half and then adjust it so that one end is 4 1/2"(11 cm) longer than the other(Fig.18).
6. Hold the folded end of the cutting line onto either of the slots in the spool.
7. Wind the line, in two even and tight layers, onto the spool. Wind the line in the direction indicated on the spool.
8. Place the ends of the line in the two opposite notches in the spool, with approximately 5"(12.5 cm) protruding from each side (Fig.19).
9. Align the notches of the spool from which the lines protrude with the eyelets in the spool retainer and position the spool in the retainer (Fig. 20).
10. Holding the spool and spool retainer, grasp one end of the line and pull it to release the line from the notch in the spool (Fig. 21). Repeat with the other end.
11. With the spool base facing downward, align the slots in the spool retainer with the tabs on the spool base and press the retainer evenly down until it snaps into place (Fig.22).



 **WARNING**

For safety reasons, the operator must read the sections of this Owner's Manual entitled **GENERAL SAFETY WARNINGS, ELECTRIC GARDENING TOOL SAFETY, SPECIFIC SAFETY RULES, BATTERY & CHARGER SAFETY, BATTERY PACK RECYCLING** and **SYMBOLS** before using this grass trimmer.

Verify the following every time the grass trimmer is used:

1. Safety glasses or goggles, hearing protection and all required safety clothing are being worn.
2. Appropriate length of trimming line is exposed beyond the trimmer line housing.
3. The area to be trimmed is cleared of all dangerous debris.
4. Bystanders are at least 50' (15 m) away from the trimming area.

Failure to observe these safety rules will significantly increase the risk of injury.

AUTOMATIC INERTIA LINE FEED SYSTEM

If the trimmer line becomes too short while trimming, simply release the trigger and let the spool come to a complete stop. The inertia line feed system will automatically feed additional trimmer line out from the spool when the trimmer is restarted.

GENERAL TRIMMING GUIDELINES

 **WARNING:** Be extremely careful when cutting around hard objects such as rock, gravel, fence posts etc. that can be contacted by the line or the spool housing. Contacting these items with the line or spool housing may cause pieces of the trimmer line and debris to be violently thrown. It may also cause the line to become entangled and damage both the line and the spool housing.

When trimming, do not feed the line into the work area too quickly and crowd the line. Only the tip of the line does the cutting. Feeding the line into the work area too quickly will reduce the head speed, slow the cutting action and overload the motor. It will also reduce the battery pack capacity before requiring recharging.

NOTE: The trimming line will easily remove grass and weeds from around walls, fences, trees and flower beds, but it can also cut the tender bark of trees or shrubs, scar fences, etc. Be extremely careful when trimming near objects that can be easily damaged by the trimmer line.

Trimming wet grass will prevent the trimmer from cutting cleanly.
Trimming wet grass will also shorten the battery life.

Always use two hands while operating the trimmer. Use one hand on the main handle to operate the switches and the other on the assist handle.

Use a semi-circular sweeping motion, with the trimmer head tilted slightly downward where the trimmer line is cutting the grass.

Move the trimmer from right to left, feeding it into the uncut grass on the left side. This motion will cause the trimmer to throw the cut grass away from the operator, reducing the amount that is thrown toward the operator.

Maintain a consistent motion and speed when moving the trimmer through the grass. This will provide a more even cut.

Hold the trimmer about 3" (7.6 cm) above the ground to avoid "scalping" and to prevent premature wear on the line and the spool cover (Fig. 23).

If the grass is taller than 6" (15.2 cm), cut the grass in stages to maintain motor speed and to prolong the battery life.

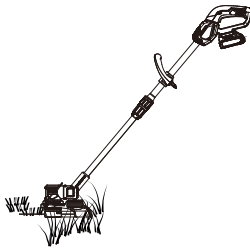

Fig. 23

If the cutting circle is getting too small, the trimmer line may be either jammed on the spool or has run out. Manually advance the line as outlined in Fig. 16. If that fails, see "CORRECTING A JAMMED OR SHORT TRIMMER LINE" below.

When finished trimming, clean the underside of the guard and the spool. Advance the line as outlined in Fig. 16 to ensure the line is the correct length for the next trimming.

CORRECTING A JAMMED OR SHORT TRIMMER LINE

Under certain conditions, the trimmer line may become jammed or too short. In either case, the line may fail to advance properly. If this happens, correct this situation as follows:

Trimmer line breaks off outside the spool housing

Press the line release button (1) on the trimmer line housing and gently pull on the exposed trimmer line until 3" (7.6 cm) of line is exposed beyond the spool housing (Fig. 16).

Trimmer line breaks off outside the spool housing

Remove the spool from the spool housing, unwind approximately 3" (7.6 cm) of line and reinstall the spool (Fig. 12 through Fig. 16).

NOTE: Remove any debris from the spool housing and spool before reinstalling the spool.

Trimmer line breaks off outside the spool housing and jams onto the spool

Remove the spool from the spool housing, unwind all the trimmer line from the spool and rewind the trimmer line onto the spool (Fig. 12 through Fig. 16).

NOTES:

- a) Remove any debris from the spool housing and spool before reinstalling the spool.
- b) Carefully wind the trimmer line onto the spool evenly to avoid overlapping wraps that will cause further jamming (Fig. 15).

EDGING

The grass trimmer can be used for edging along a sidewalk or other areas where a smooth well defined grass line is required.

⚠ WARNING: Always use long pants, long sleeve shirt, gloves and safety goggles and a face shield when edging. Debris being thrown from the trimmer at high speed can injure your eyes and any exposed skin. Always have the exposed trimmer line facing away from your body to reduce the risk of injury from debris being thrown by the trimmer.

1. Remove the battery pack from the trimmer.
2. Press the button named "Press for edging" so the guard is parallel with the telescoping tube (Fig. 10).
3. Rotate the trimmer head so the trimmer line is facing away from your body and the edging wheels are down (Fig. 10).
4. Place the edging wheels on the sidewalk with the trimming line positioned where you want to create the smooth edge.
5. Reconnect the battery, turn the grass trimmer ON and move it forward to edge the area.
NOTE: If the area to be edged is too thick with grass, lift the grass trimmer up slightly before turning it ON and allow the motor to come up to full speed before carefully lowering it so the edging wheels touch the sidewalk.
6. Turn the grass trimmer OFF before removing it from the edging position.

MAINTENANCE

GENERAL

 **WARNING: When servicing, use only identical replacement parts. The use of any other parts may create a hazard or cause product damage.**

DO NOT use solvents when cleaning plastic parts. Plastics are susceptible to damage from various types of commercial solvents and may be damaged by their use. Use a clean cloth to remove dirt, dust, oil, grease etc.

 **WARNING: Do not allow brake fluids, gasoline, petroleum-based products, penetrating oils, etc. to come into contact with plastic parts. They contain chemicals that can damage, weaken or destroy plastic.**

DO NOT abuse power tools. Abusive practices can damage the tool and the workpiece.

 **WARNING: DO NOT attempt to modify tools or create accessories. Any such alteration or modification is misuse and could result in a hazardous condition leading to possible serious injury. It will also void the warranty.**

LUBRICATION

All of the bearings in this tool are lubricated with a sufficient amount of high-grade lubricant for the life of the unit under normal conditions. Therefore, no further lubrication is required.

BATTERY PACK REMOVAL AND PREPARATION FOR RECYCLING

To preserve our natural resources, please recycle or dispose of batteries properly.

The batteries accompanying this tool may contain chemicals and metals that are harmful to the environment. Never dispose of rechargeable batteries in your normal household garbage or in landfill sites, because they will add to the pollution of the environment.

Consult your local waste authority for information regarding available recycling and disposal options.

 **WARNING: Upon removal of the battery pack, cover the terminals of the battery pack with electrical tape or heavy-duty adhesive tape. Never touch both terminals with metal objects or parts, because a short circuit may result. Keep away from children. Do not attempt to destroy or disassemble battery pack or remove any of its components. Rechargeable batteries must be recycled or disposed of properly. Failure to comply with these warnings could result in fire and serious injury.**

EXPLODED VIEW

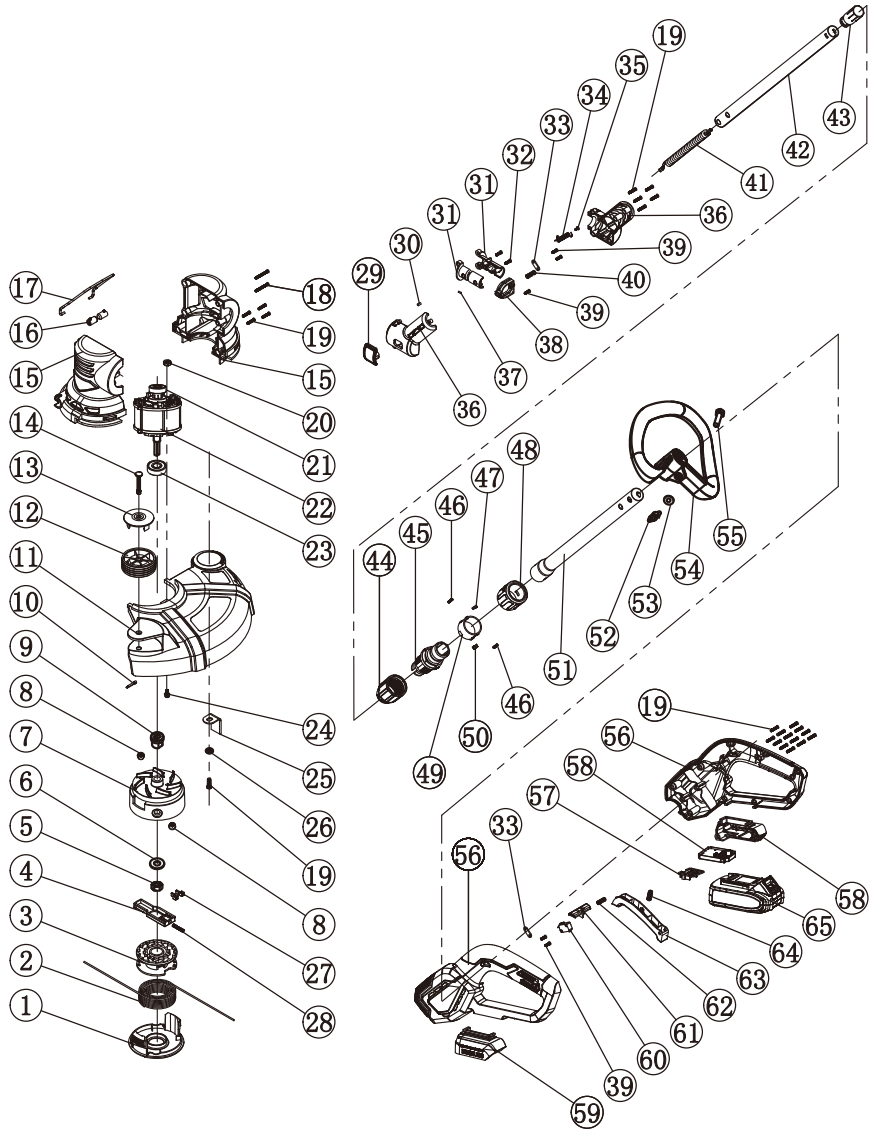

PARTS LIST

⚠ WARNING: When servicing, use only original equipment replacement parts. The use of any other parts may create a safety hazard or cause damage to the grass trimmer.

Any attempt to repair or replace electrical parts on this grass trimmer may create a safety hazard unless repairs are performed by a qualified technician. For more information, call the Toll-free Helpline, at 1-866-349-8665 – Friday from 9am to 5pm Eastern Standard Time.

Always order by PART NUMBER, not by key number.

Key #	Part #	Part Name	Quantity
1	3160090138	Spool cap cover	1
2	6280010022	Trimmer line	1
3	3150190232	Trimmer line spool	1
4	3150130191	Line block	1
5	4060010041	M6 hexagon nut	1
6	2030020384	Washer $\Phi 6 \times \Phi 16 \times t1.5$	1
7	3160090139	Trimmer line box	1
8	2020220013	Outlet line sheath	2
9	2010080162	Shaft sleeve	1
10	4150010001	Pin	1
11	3160040135	Guard	1
12	3150230006	Roller	1
13	3150230006	Roller cover	1
14	3150130143	Roller shaft	1
15	3010220008	Motor housing	1
16	3150190193	Protective steel wire plug	2
17	2050080232	Protective steel wire	1
18	4030010125	Screw ST3.9 x 35	2
19	4030010242	Screw ST3.9 x 16	23
20	4060010005	M4 hexagon nut	1
21	4010010034	Bearing 607-2Z	1
22	1030300028	Motor	1
23	4010010038	Bearing 609-2Z	1
24	4020010174	Crew M4x12	1
25	2030030263	Blade	1
26	2030020409	Washer $\Phi 4.2 \times \Phi 12 \times t1$	1
27	2010130048	Balance block	6
28	2050060243	Spring	1
29	3120020142	Rotating button	1
30	3140060002	Shock pad $\Phi 4 \times 7$	1
31	3150130141	Rotation axis	1
32	4030010099	Screw ST3.9 x 14	2
33	2030050002	Cable clamp plate	2

Key #	Part #	Part Name	Quantity
34	2050060242	Rotating button	1
35	4030010259	Screw PWA3 X 7	1
36	3010220002	Rotating housing	1
37	4110010015	Pin $\Phi 2.5 \times 7$	1
38	3150190192	Retaining ring	1
39	4030010096	Screw ST3.9 x 12	5
40	2050040067	Spring	1
41	1190370002	Cable	1
42	2020220012	Aluminum tube	1
43	3150190190	Aluminum tube connector	1
44	3120080132	Adjusting knob	1
45	3150190189	Connecting pipe	1
46	2050060239	Spring	2
47	3150130139	Thin slider	1
48	3120080133	Angle adjustment knob	1
49	3150190191	Angle lock sleeve	1
50	3150130138	Thick slider	1
51	2020220011	Coarse aluminum tube	1
52	1180050050	Knob	1
53	2030020410	Washer $\Phi 6.2 \times \Phi 18 \times t1$	1
54	3120070155	Auxiliary handle	1
55	4050010029	Hexagon bolt M6 x 40	1
56	3010220009	Handle housing	1
57	3150170020	Electrode plate	1
58	1130030123	Brushless control PCB	1
59	3010220010	Housing cover plate	1
60	1062010038	Switch	1
61	3120040067	Switch lock lever	1
62	2050040073	Spring	1
63	3120010108	Switch button	1
64	2050040068	Switch trigger spring	1
65	1290090019	Battery	1

WARRANTY

BENCHMARK 12" CORDLESS BRUSHLESS 20V MAX* LAWN TRIMMER

If this Benchmark tool fails due to a defect in material or workmanship within five years from the date of purchase, return it to any Home Hardware store with the original bill of sale for exchange. 3 years for the battery and the charger.

This warranty does not include expendable parts including but not limited to blades, brushes, belts, light bulbs.

This warranty covers defects in material or workmanship only. It does not cover normal wear and tear, failure due to abuse/misuse, or defects caused by careless or accidental mishandling. If this Benchmark product is used for commercial or rental purposes, this warranty does not apply.

12" CORDLESS BRUSHLESS 20V MAX* LAWN TRIMMER



5 Year Limited Warranty on tool
3 Year Limited Warranty on battery and charger

BENCHMARK™
MC

BENCHMARK TOOLS CANADA
ST. JACOBS, ONTARIO N0B 2N0
© 2023 Home Hardware Stores Limited

CUSTOMER SERVICE/TECH SUPPORT
1-866-349-8665

5073-100

Made in China



* This Benchmark™ product carries a five (5) year LIMITED warranty against defects in workmanship and materials. The charger and batteries carry a three (3) year LIMITED warranty. See Owner's Manual for full details.



E114847
JD5516-BL

**READ ALL INSTRUCTIONS BEFORE FIRST USE.
KEEP THIS MANUAL FOR FUTURE REFERENCE.
KEEP AWAY FROM CHILDREN.**

* Maximum initial battery voltage (measured without a load) is 20 volts.
Normal voltage is 18 volts.



**WEAR CSA APPROVED
EYE PROTECTION**



**WEAR EAR
PROTECTION**



**WEAR A
FACE MASK**