

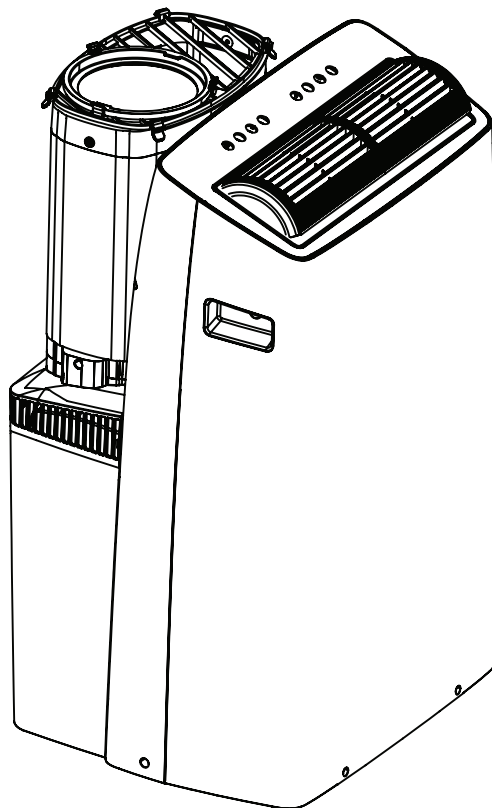

USER MANUAL

Duo Portable Air Conditioner

Capacity: 12000 ~ 14000BTU/h



Warning:
Before using this product,
please read this manual carefully
and keep it for future reference.
The design and specifications
are subject to change without
prior notice for product
improvement. Consult with your
dealer or the manufacturer for
details.

SAFETY PRECAUTIONS 3

OPERATING INSTRUCTIONS 8

INSTALLATION INSTRUCTIONS 12

CARE AND CLEANING 19

TROUBLESHOOTING TIPS 20

HEAT PUMP HOSE INSULATION FOAM 21

REMOTE CONTROL AND APP INSTRUCTIONS 22

WARRANTY 30

Read This Manual

Inside you'll find many helpful hints on how to use and maintain your air conditioner properly. Just a little preventive care on your part can save you a great deal of time and money over the life of your air conditioner. You'll find many answers to common problems in the troubleshooting tips - you should be able to fix most of them quickly before calling service. These instructions may not cover every possible condition of use, so common sense and attention to safety is required when installing, operating and maintaining this product.



CAUTION

- For support, please call the Service Center at 1-866-646-4332.
- This appliance is not intended for use by people (including children) with reduced physical, sensory, or mental capabilities or lack of experience and knowledge, unless they have been given supervision or instruction concerning use of the appliance by a person responsible for their safety.
- Children should be supervised to ensure that they do not play with the air conditioner.
- The appliance shall be installed in accordance with national wiring regulations.
- Do not operate your air conditioner in a humid room such as a bathroom or laundry room.

SAFETY PRECAUTIONS

To prevent injury to the user or other people and property damage, the instructions shown here must be followed. Incorrect operation due to ignoring of instructions may cause harm or damage. The level of risk is shown by the following indications.

WARNING

This symbol indicates a hazardous situation which, if not avoided, could result in death or serious injury.

CAUTION

This symbol indicates a hazardous situation, which, if not avoided, could result in minor or moderate injury.

NOTICE

This symbol addresses practices not related to physical injury.

WARNING

- Be sure the air conditioner has been securely and correctly installed according to the installation instructions in this manual. Save this manual for possible future use in removing or installing this unit.
- Plug in power cord plug properly.
Otherwise, it may cause electric shock or fire due to excess heat generation.
- Do not modify power cord length or share the outlet with other appliances as it may cause electric shock or fire due to overheating.
- Always ensure effective grounding.
Incorrect grounding may cause electric shock.
- Unplug the unit if you notice unusual sounds or smells or smoke coming from it.
A damaged product may cause fire and electric shock.
- Ventilate room before operating the air conditioner if there is a gas leakage from another appliance.
- Do not operate or stop the unit by inserting or pulling out the power cord plug.
- Do not operate with wet hands or in very humid environments.
It may cause electric shock.
- Do not allow water to come into contact with any electric parts.
It may cause failure or electric shock.
- Do not use the socket if it is loose or damaged.
It may cause fire and electric shock.
- Do not use or keep the power cord close to heating appliances.
It may cause fire and electric shock.
- Do not use any devices or materials for installation that are not recommended in this manual.

 **WARNING**

- Do not disassemble or modify unit.
It may cause failure and electric shock.
- Do not damage or use an alternate power cord.
It may cause fire and electric shock.
If the power cord is damaged, it must be replaced by the manufacturer or an authorized service center or a similarly qualified person in order to avoid a hazard.
- Do not direct airflow straight into persons to avoid possible health hazard.
- Do not open the unit during operation.
It may cause electric shock.
- Do not use the power cord near flammable gas or combustibles, such as gasoline, benzene, thinner, etc.
It may cause an explosion or fire.
- Do not let children hang on the air conditioner or bracket.
A serious injury may occur.
- Avoid fire hazard or electric shock. Do not use an extension cord or an adaptor plug. Do not remove any prongs from the power cord.
- Be sure the air conditioner is properly grounded. To minimize shock and fire hazards, proper grounding is important. The power cord is equipped with a three-prong grounding plug for protection against shock hazards.
- Your air conditioner must be used in a properly grounded wall receptacle. If the wall receptacle you intend to use is not adequately grounded or protected by a time delay fuse or circuit breaker, have a qualified electrician install the proper receptacle. Ensure the receptacle is accessible after the unit installation.
- Be sure the electrical service is adequate for the model you have chosen. This information can be found on the serial plate, which is located on the side of the cabinet and behind the grille.





 **CAUTION**

- When the air filter is to be removed, do not touch the metal parts of the unit.
It may cause injury.
- When the unit needs cleaning, switch off, and turn off the circuit breaker.
Do not clean unit when power is on as it may cause fire, electric shock or injury.
- Do not place obstacles around air inlets or inside of air outlet.
It may cause failure or accident.
- Clean with a soft cloth only. Do not use strong detergents that contain wax or thinners as it may damage the product.
- Use caution when unpacking and installing. Sharp edges could cause injury.
- Do not clean the air conditioner with water.
Water may enter the unit and degrade the insulation which could lead to electric shock.

**CAUTION**

- Do not put a pet or house plant where it will be exposed to direct air flow. This could injure the pet or harm the plant.
- Hold the plug by the head of the power plug when taking it out. Otherwise, it may cause electric shock and damage.
- Ensure that the installation is properly secured to prevent the product from potentially falling.
- Do not place heavy objects on the power cord and ensure that the cord is not compressed. Otherwise, there is danger of fire or electric shock.
- If water is spilled on the unit, turn off the unit and switch off the circuit breaker. Isolate supply by taking the power-plug out and contact customer service.
- Do not use near gas stove or other gas burning appliances, as air flow may affect gas combustion.
- Do not use for any purpose other than room comfort. Do not use this air conditioner to preserve precision devices, food, pets, plants, and art objects. It may cause deterioration.
- Turn off the main power switch if the unit is not to be used for an extended time.
- Always insert the filters securely. Clean filter once every two weeks. Operation without filters may cause failure.
- Do not drink water drained from the air conditioner.

EXPLANATION OF SYMBOLS DISPLAYED ON THE UNIT

	WARNING	This symbol shows that this appliance used a flammable refrigerant. If the refrigerant is leaked and exposed to an external ignition source, there is a risk of fire.
	CAUTION	This symbol shows that the operation manual should be read carefully.
	CAUTION	This symbol shows that a service personnel should be handling this equipment with reference to the installation manual.
	CAUTION	This symbol shows that information is available such as the operating manual or installation manual.



WARNING (for using R32 refrigerant only)

- Do not try to accelerate the defrosting process or methods of cleaning that are not recommended by the manufacturer.
- The appliance shall be stored in a room without a continuously operating ignition source (for example, open flames or an operating gas appliance) or an ignition source (for example, an operating electric heater) close to the appliance. The appliance shall also be stored in a room without ignition sources.
- Do not pierce or burn.
- Be aware that the refrigerants may not contain an odor.
- Keep ventilation openings clear of obstruction.
- Unit is only to be serviced by a Midea authorized servicer, please call Customer Service at 1-866-646-4332 for support.
- Flammable refrigerant R32 is used within air conditioner. Please follow the instructions carefully to handle, install, clean, and service the air conditioner to avoid damage or hazard. Do not dispose of air conditioner in regular trash. Contact qualified agency for proper disposal.
- No open fire or devices that generate spark/arc shall be around the air conditioner to avoid causing ignition of the flammable refrigerant used. Please follow the instructions carefully to store or maintain the air conditioner to prevent mechanical damage from occurring.

Operation of Current Device

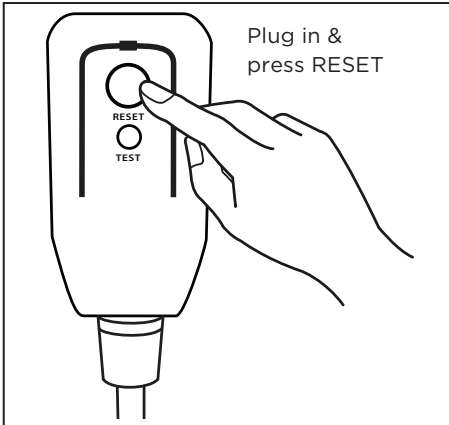

The power supply cord contains a current measuring device that detects damage to the power cord. Test your power supply cord as follows:

1. Plug in the air conditioner.
2. The power supply cord will have TWO buttons on the plug head. Press the TEST button. You will notice a click as the RESET button pops out.
3. Press the RESET Button. You will notice a click as the button engages.
4. The power supply cord is now supplying electricity to the unit. (On some products this is also indicated by a light on the plug head.)

Grounding type wall receptacle

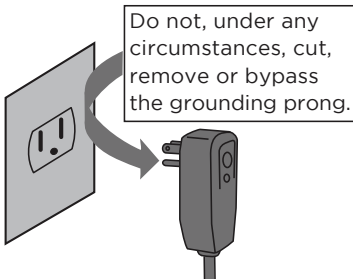

Power supply cord with 3-prong grounding plug and current detection device.

NOTICE

The power supply cord with this air conditioner contains a current detection device designed to reduce the risk of fire.

In the event that the power supply cord is damaged, it can not be repaired. It must be replaced with a cord from the manufacturer.

NOTICE

- Do not use this device to turn the unit on or off.
- Always make sure the RESET button is pushed in for correct operation.
- The power supply cord must be replaced if it fails to reset when either the TEST button is pushed, or it can not be reset. Please contact Customer Service.

OPERATING INSTRUCTIONS

Preparation

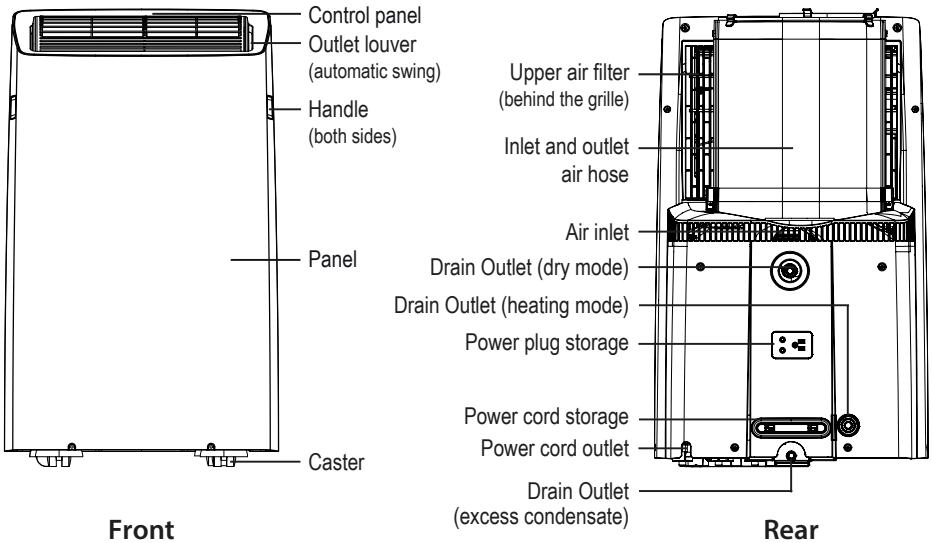

Unit Operating Temperature Range:

Mode	Temperature Range
Cool	16°C ~ 35°C (60°F ~ 95°F)
Dry	13°C ~ 35°C (55°F ~ 95°F)
Heat Pump (for heat model)	5°C ~ 30°C (41°F ~ 86°F)

Control Panel Features

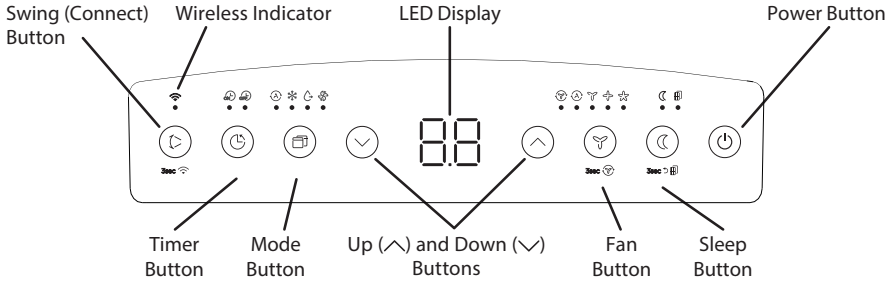

Swing Button

Used to initiate the Auto Swing feature. When the operation is ON, pressing the SWING button can stop the louver at the desired angle.

Connect Button

The swing button is also used to initiate the wireless connection mode. To initiate the wireless connection mode, power on the air conditioner then press the SWING button for 3 seconds. The LED DISPLAY will show 'AP' to indicate the unit is in wireless connection mode. Refer to the app connection instructions to finish the connection process.

If the connection is successful, the unit will exit wireless connection mode and illuminate the wireless LED. If the connection fails, the unit will exit wireless connection mode automatically after 8 minutes and the wireless LED does not illuminate. NOTE: The wireless connection process must be completed within 8 minutes after powering the air conditioner on.

Timer Button

Used to initiate the AUTO ON start time and AUTO OFF stop time program. The timer on or off light will illuminate depending on the selected setting.

Fan Button

Controls the fan speed. Press to control the fan speed in four steps - LOW, MID, HIGH and AUTO. The selected fan speed light (except AUTO) will illuminate.

NOTE: Applicable to models with the Constant Fan feature. In COOL or DRY mode, press the Fan button for 3 seconds to turn on or off the constant fan function.

When the function is turned on, the constant fan light will illuminate, indicating the fan will run constantly. When the function is turned off, the constant fan light will go out, indicating that the fan will stop when the compressor stops.

Mode Button

Selects the desired operating mode. Each time you press the button, a mode is selected in a sequence that goes from AUTO, COOL, DRY, FAN and HEAT (Heat models only). The mode light illuminates and indicates the selected mode.

Up (^) and Down (v) Buttons

Used to increase/decrease temperature settings in 1° increments in a range of 60°F/16°C to 86°F/30°C or the TIMER setting in a range of 0 - 24hrs.

To change between °F or °C, simultaneously press and hold the Up and Down buttons for 3 seconds.

Power Button

Powers the unit on and off.

Sleep Button

Used to initiate the SLEEP operation.

LED Display

Shows the set temperature in °F (Degrees Fahrenheit) or °C (Degrees Celsius) and the Auto-timer settings. While on DRY and FAN modes, it shows the room temperature.

Shows Error codes and protection code:

- E1** - Room temperature sensor error.
- E2** - Evaporator temperature sensor error.
- E3** - Condenser temperature sensor error (select models).
- E4** - Display panel communication error.
- P1** - Bottom tray is full - Connect the drain hose and drain the collected water away. If protection code repeats, call for service.

NOTICE

When one of these error codes occurs, turn off the unit and check for any obstructions. Restart the Unit. If the malfunction persists, turn off the unit and unplug the power cord and contact customer service at 1-866-646-4332.

Operating Instructions

COOL operation

- Press the "MODE" button until the "COOL" indicator light comes on.
- Press the ADJUST buttons Up (∧) or Down (∨) to select your desired room temperature. The temperature can be set within a range of 60°F-86°F/16°C-30°C.
- Press the "FAN SPEED" button to choose the fan speed.

HEAT operation (for heat model)

- Press the "MODE" button until the "HEAT" indicator light comes on.
- Press the ADJUST buttons Up (∧) or Down (∨) to select your desired room temperature. The temperature can be set within a range of 60°F-86°F/16°C-30°C.
- Press the "FAN SPEED" button to choose the fan speed.
- When entering heat mode, the fan may start slower than expected. For some models, the fan speed cannot be adjusted while in HEAT mode.

DRY operation

- Press the "MODE" button until the "DRY" indicator light comes on.
- While in this mode, you cannot select a fan speed. The fan motor operates at AUTO speed.
- Keep windows and doors closed for the best dehumidifying effect.

AUTO operation

- When you set the air conditioner to AUTO mode, it will automatically select cooling, heating (Heat models only) or fan only operation depending on what temperature you have selected and the current room temperature.
- The air conditioner will control room temperature automatically according to the temperature point set by you.
- Under AUTO mode, you cannot select the fan speed.

FAN operation

- Press the "MODE" button until the "FAN" indicator light comes on.
- Press the "FAN SPEED" button to choose the fan speed. The temperature cannot be adjusted.
- Do not connect the duct to a window.

TIMER: Auto Start/Stop Operation

- When the unit is on, pressing the Timer button will initiate the Auto stop program. The TIMER OFF indicator light illuminates. Press the Up (∧) or Down (∨) button to select the desired time. Press the TIMER button again within 5 seconds. The Auto start program is initiated and the TIMER ON indicator light illuminates. Press the Up (∧) or Down (∨) button to select the desired Auto start time.
- When the unit is off, press the Timer button to initiate the Auto start program. Pressing it again within five seconds will initiate the Auto stop program.
- Press or hold the Up (∧) or Down (∨) button to change the Auto time by 0.5 hour increments, up to 10 hours, then at 1 hour increments up to 24 hours. The control will count down the time remaining until start.
- The system will automatically revert back to display the previous temperature setting if there is no operation within 5 seconds.
- Turning the unit ON or OFF at any time or adjusting the timer setting to 0.0 will cancel the Auto Start/Stop timer program.
- Should a malfunction occur, the Auto Start/Stop timed program will also be cancelled.

SLEEP operation

Pressing this button will increase (during cooling operation) or decrease (during heating operation, applicable models) 2°F/1°C after 30 minutes. The temperature will again increase (cooling) or decrease (heating) by another 2°F/1°C after an additional 30 minutes. This new temperature will be maintained for 7 hours before returning to the originally selected temperature. This ends the Sleep mode and the unit will continue to operate as originally programmed.

NOTICE

The SLEEP operation feature is unavailable in FAN or DRY mode.

Other Features

COMFORT SENSE feature

This feature can ONLY be activated from the remote control. The remote control serves as a remote thermostat allowing for the precise temperature control at its location, which must be within 26 feet of the air conditioner. To activate the Comfort Sense feature, point the remote control towards the unit and press the SET button to select. The remote's display will show the actual temperature at its location (as long as it is within the 26 feet of the air conditioner). The remote control will send this signal to the air conditioner every 3 minutes until the C-Sense button is select again. If the unit does not receive the Comfort Sense signal during any 7 minutes interval, the unit will exit the Comfort Sense mode.

NOTE: This feature is unavailable under FAN or DRY mode.

AUTO-RESTART

If the unit shuts off unexpectedly due to a power outage, it will restart with the previously set function automatically when the power resumes.

WAIT 3 MINUTES BEFORE RESUMING OPERATION

After the unit has stopped, it cannot be restarted until 3 minutes time has elapsed. This is to protect the unit. Operation will automatically resume after 3 minutes.

AIRFLOW DIRECTION ADJUSTMENT

The louver can be adjusted automatically using the SWING button.

- When the Power is ON, the louver opens fully.
- Press the SWING button on the panel or remote controller to initiate the Auto Swing feature. The louver will swing up and down automatically.
- Please do not adjust the louver manually.

INSTALLATION INSTRUCTIONS

Choosing the Right Location

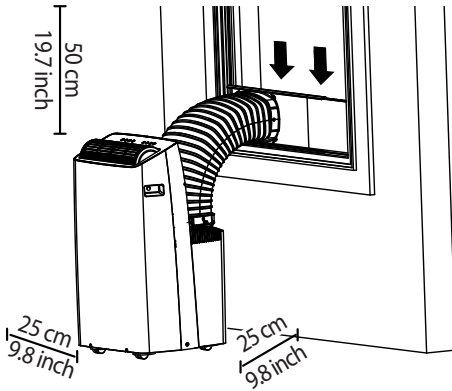

Your installation location should meet the following requirements:

- Make sure that you install your unit on an even surface to minimize noise and vibration.
- The unit must be installed near a grounded plug, and the Collection Tray Drain (found on the back of the unit) must be accessible.
- The unit should be located at least 9.8" (25cm) from the nearest wall to ensure proper air conditioning.
- DO NOT cover the Intakes, Outlets or Remote Signal Receptor of the unit, as this could cause damage to the unit.

Recommended Installation

NOTICE

The appearance of your unit might be slightly different.

⚠ WARNING

- This air-conditioning unit is a hermetically sealed unit that contains fluorinated gasses. For specific information on the type of gas and the amount, please refer to the relevant label on the unit itself.
- Service, maintenance or repair of this unit must be performed by a certified technician.
- Product recycling must be done according to local regulations.

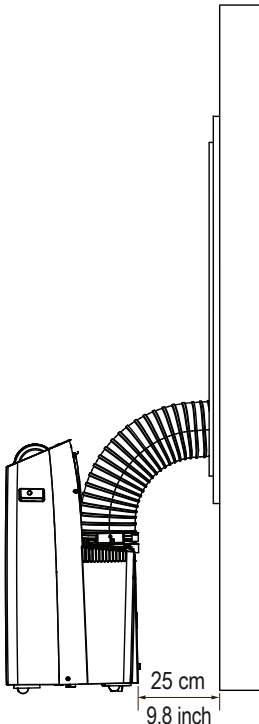

Scan this QR code to watch an installation video for your Midea Duo Portable Air Conditioner:





















Tools Needed

- Phillips screwdriver
- Tape measure or ruler
- Knife or scissors
- Saw (optional, to shorten window adaptor for narrow windows).

Accessories

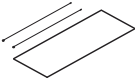
Your Window Installation Kit fits windows 19.1" – 63.8" (48.4-162 cm). Please doublecheck all packaging materials to make sure accessories do not get accidentally thrown away.

Part	Description	Quantity
	Air exhaust adapter	1 pc
	Bolt	8 pc
	Window Sliders	5 pc
	Window Kit Brace	1 pc
	Sliding Window Adapter - Front	1 pc
	Sliding Window Adapter - Rear	1 pc
	Sliding Window Adapter - Air Divider	1 pc
	Foam seal A (adhesive)	4 pc
	Foam seal B (adhesive)	2 pc
	Foam seal C (Non-adhesive)	2 pc
	Window Slider Foam (adhesive)	2 pc
	Security bracket and 2 screws	1 set
	Drain hose	1 pc
	Drain hose adaptor (For heat pump mode only)	1 pc
	Remote controller and battery	1 set
	Power Cord Buckle (For cooling only model)	1 pc
	Heat pump hose insulation foam (optional)	1 set
	1 Screw (on Exhaust adaptor)	1 pc

Window Installation Kit

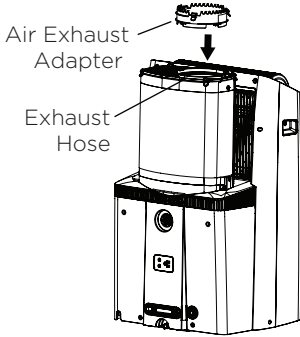

1: For Hung Window types only

Insert the Air Exhaust Adapter into the exhaust of the hose (the circular opening) for optimal performance. Rotate the adapter clockwise until the locking tabs click and it no longer rotates.

Skip this step if installing into a horizontal sliding window.

The Air Exhaust adapter may interfere with some window screens, and can be removed if desired (Please note this may slightly decrease performance).

2: Preparing the adjustable window slider

1. Depending on the size of your window, adjust the size of the window slider. Use the combination of panels that best fits your window opening.
2. If the length of the window requires two or more window sliders, use the bolt to fasten the window sliders once they are adjusted to the proper length.
3. If installing in a sliding window, bolts should be installed on both sides of the window sliders.

Three Window Sliders with side holes

Two Window Sliders without side hole

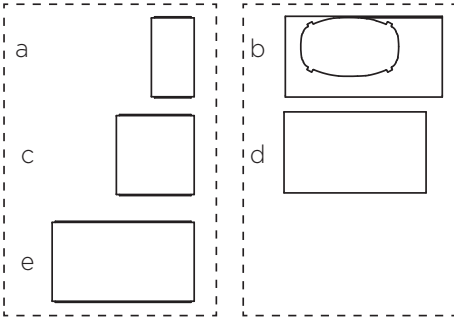

Use the table below to determine what combination of Window Sliders is correct for your window

window slider	window dimension (mm)		window dimension (inch)	
a+b	484	~ 592	19.1	~ 23.3
b+c	592	~ 696	23.3	~ 27.4
a+b+c	696	~ 802	27.4	~ 31.6
b+e	802	~ 896	31.6	~ 35.3
a+b+e	896	~ 998	35.3	~ 39.3
a+b+c+d	998	~ 1210	39.3	~ 47.6
a+b+c+d+e	1210	~ 1620	47.6	~ 63.8

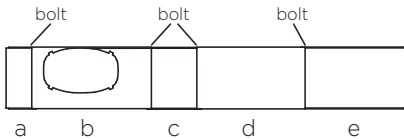

Windows Type

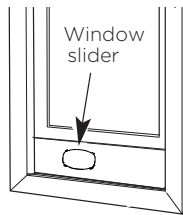

Hung Window

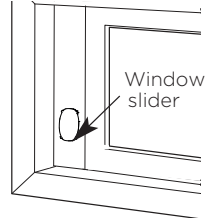

Sliding Window

3: Applying insulation to the window slider

After assembling the window slider to your proper dimension, cut and apply the foam insulation sheets to the exterior side of the window slider.

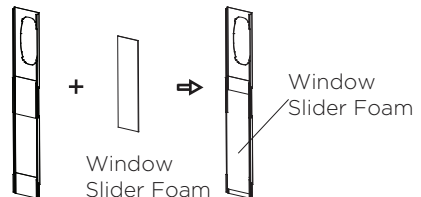

NOTICE

Once the Exhaust Hose assembly and Adjustable Window Slider are prepared, choose from one of the following two installation methods.

Foam seal B
(Adhesive type-shorter)

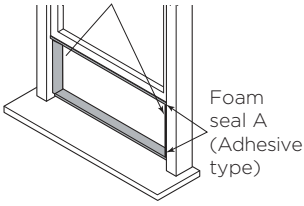

Type 1: Hung window installation

1. Cut the adhesive foam seal A and B strips to the proper lengths, and attach them to the window sash and frame as shown.

2. Insert the window slider assembly into the window track. If the hose opening is covered by the lip of the window frame, rotate the panel so the thicker side faces the window frame. Attach the Window Kit Brace to the back of the hose panel to brace against the window so the window slider panels do not lean inward.

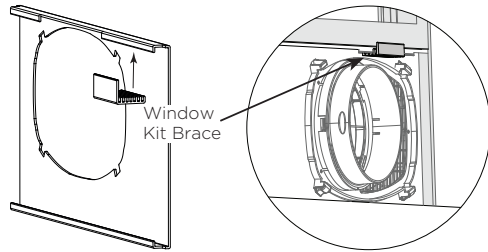
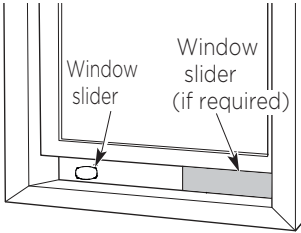

3. Cut the non-adhesive foam seal C strip to match the width of the window. Insert the seal between the glass and the window frame to prevent air and insects from getting into the room.

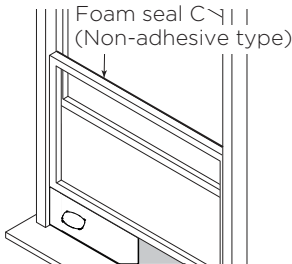

4. If desired, install the security bracket with 2 screws as shown.

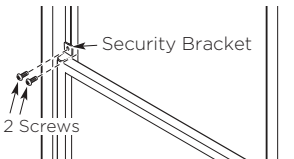

5. Attach the hose to the window slider panel by inserting the end of the hose into the opening on the slider.

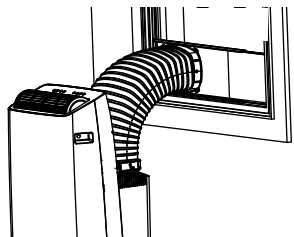

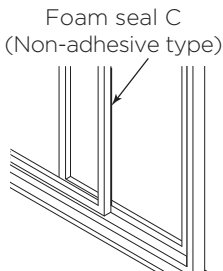
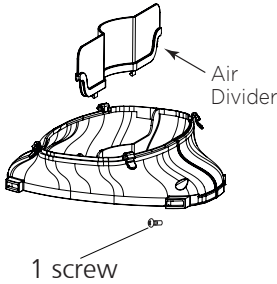
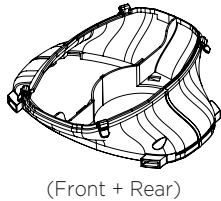
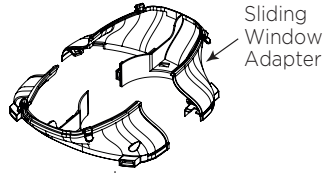
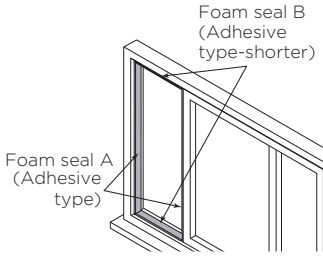

Type 2: Sliding window Installation (Optional)

1. Cut the adhesive foam seal A and B strips to the proper lengths, and attach them to the window sash and frame as shown.
2. Assembling the Sliding Window Adapter (Only needed for Sliding Window applications): Align both halves of the sliding window adapter and connect them. Then, attach the air divider to the newly formed window adapter on the outdoor side. The fully assembled adapter should look like the image at the left.
3. Insert the window slider assembly into the window track. If the hose opening is covered by the window frame, rotate the panel so the thicker side faces the window frame. Attach the Window Kit Brace to the back of the hose panel to brace against the window so the window slider panels do not lean inward.
4. Be sure bolts are installed in both sides of the window slider for improved rigidity.

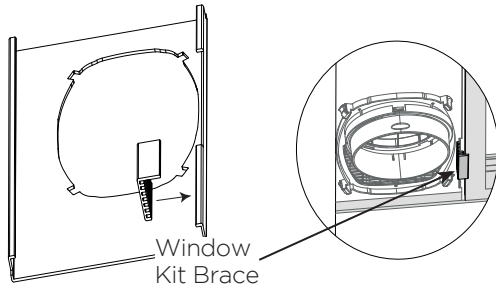
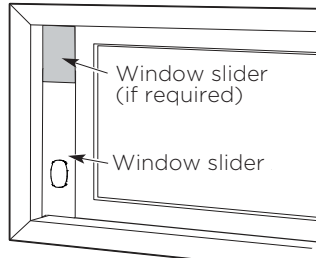

5. Cut the non-adhesive foam seal C strip to match the window height. Insert the foam seal between the glass and the window frame to prevent air and insects from getting into the room.

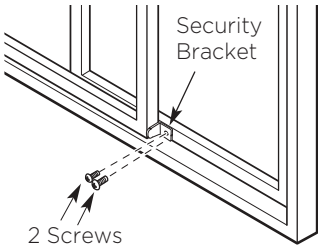

- If desired, install the security bracket with 2 screws as shown.

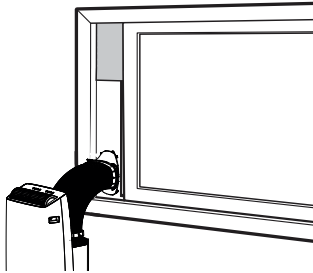

- Attach the Sliding Window Adapter to the hose by lining up the circles on the adapter the hose. Insert the window slider adapter into the hole of the window slider.

NOTICE

To ensure proper function, DO NOT overextend or bend the hose. Make sure that there are no objects within 20in (~500mm) of the inlet and outlet hose. All illustrations in this manual are for explanation purposes only, your air conditioner may be slightly different than shown.

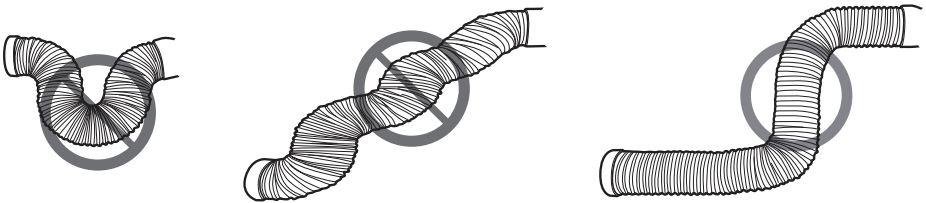

Water Drainage

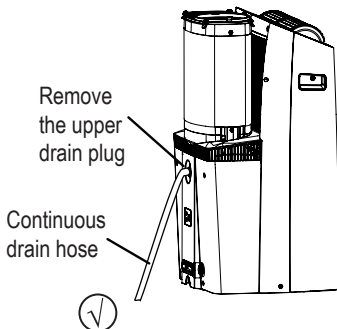

- During Dry modes, remove the upper drain plug from the back of the unit and install the drain hose. For models without drain connector, just attach the drain hose to the hole. Place the end of the hose directly in the drain area you're using.

Water Drainage (For Heating Mode)

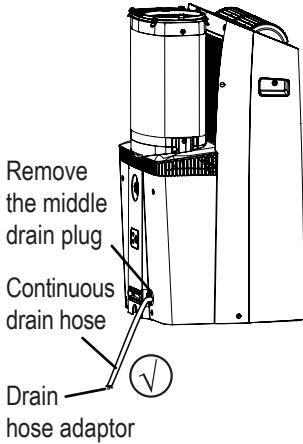

- While operating in heat pump mode, the unit will produce condensate that must be drained. You must install the drain hose when operating in heat mode. To install the drain hose, remove the plug from the drain port and attach the included hose. The universal drain adaptor can be attached to the end of the included hose. A 3/4" hose (not included) can be attached to the adaptor if a longer hose length is required. Place the end of the hose in the drain area you are using.

NOTICE

Because this unit contains a condensate pump, the drain hose can be elevated up to 6 ft. (1.8 m). Direct the hose toward the drain, making sure there are no kinks that will restrict water flow. Make sure the end of the hose is directed downward (see fig. ✓ with check mark symbol).

The figure with ✗ symbol is not recommended as the end of the hose is not directed downward. When the continuous drain hose is not used, ensure that the corresponding drain plug and knob are installed firmly to prevent leaks.

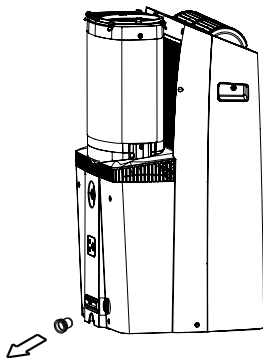
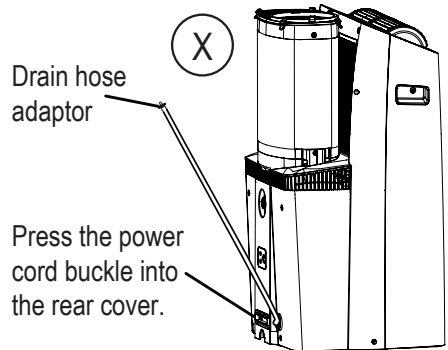
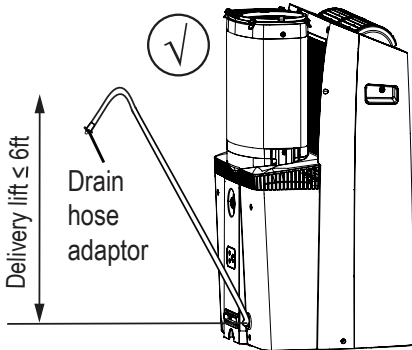

- When the water level of the bottom tray reaches a predetermined level, the unit beeps 8 times. The digital display shows "P1." At this time the air conditioning/dehumidification process will immediately stop. However, the fan motor will continue to operate (this is normal). Carefully move the unit to a drain location, remove the bottom drain plug and let the water drain away. Reinstall the bottom drain plug and restart the machine until the "P1" symbol disappears. If the error repeats, call for service.

NOTICE

Be sure to reinstall the bottom drain plug firmly to prevent leakage before using the unit.

CARE AND CLEANING

Safety Precautions

- Always unplug the unit before cleaning or servicing.
- DO NOT use flammable liquids or chemicals to clean the unit.
- DO NOT wash the unit under running water. Doing so causes electrical danger.
- DO NOT operate the machine if the power supply was damaged during cleaning. A damaged power cord must be replaced with a new cord from the manufacturer.

Air Filter Cleaning

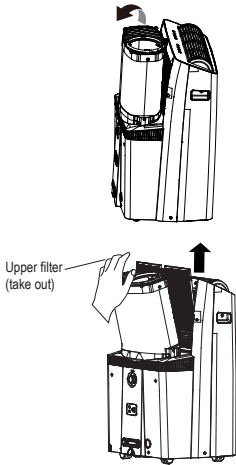

⚠ CAUTION

DO NOT operate the unit without filter because dirt and lint will clog it and reduce performance.

Maintenance Tips

- Be sure to clean the air filter every 2 weeks for optimal performance.
- Clean the filter using water and ensure it is dry before reinstalling.
- The water collection tray should be drained immediately after P1 error occurs, and before storage to prevent mold.
- In households with animals, you will have to periodically wipe down the grill to prevent blocked airflow due to animal hair.
- Notice the air filter is integrated with the removable grille cover.

Unit Cleaning

Clean with a soft cloth only. Do not use strong detergents that contain wax or thinners as it may damage the product

Store the Unit When Not in Use

- Drain the unit's water collection tray according to the instructions in the following section.
- Run the unit on FAN mode for 12 hours in a warm room to dry it and prevent mold.
- Turn off the unit and unplug it.
- Clean the air filter according to the instructions in the previous section. Reinstall the clean, dry filter before storing.
- Remove the batteries from the remote control.

NOTICE

Be sure to store the unit in a cool, dark place. Exposure to direct sunlight or extreme heat can shorten the lifespan of the unit.

TROUBLESHOOTING TIPS

Before calling for service, review this list. It may save you time and expense. This list includes common occurrences that are not the result of defective workmanship or materials in this appliance.

Problem	Solution
Unit does not turn on when pressing ON/OFF button	Displays P1 Error Code and means the water collection tray is full. Turn off the unit, drain the water from the water collection tray, and restart the unit.
	If room temperature is lower than the set temperature in COOL mode, reset the temperature.
Unit does not cool well	The air filter is blocked with dust or animal hair. Turn off the unit and clean the filter according to the instructions.
	Exhaust hose is not connected or is blocked. Turn off the unit, disconnect the hose, check for blockage and reconnect the hose.
	Temperature setting is too high; decrease the set temperature.
	Make sure all windows and doors are closed.
	The room area could be too large; doublecheck the cooling area.
	Check the room for possible heat sources and remove them if possible.
The unit is noisy and/or vibrates too much	The floor is not level. Place the unit on a flat, level surface.
	The air filter is blocked with dust or animal hair. Turn off the unit and clean the filter according to the instructions.
The unit makes a gurgling sound	This sound is caused by the refrigerant flow inside the unit and is normal.
Unit will not connect to Wireless or App does not work (some modes)	For additional support and troubleshooting tips, follow the link in the QR code:
	
The top of the window kit leans forward out of the window track	Ensure the Window Kit brace is installed properly.
In heating mode, the fan speed is lower than expected.	It is normal for the fan speed to start low in heating mode. The fan speed should reach your desired setting after a few minutes of operation.
Condensation collects on the outer section of the hose in heat mode	Apply the included hose insulation foam as shown on the next page.

NOTICE

Do not add extension to the exhaust hose(s)!

HEAT PUMP HOSE INSULATION FOAM

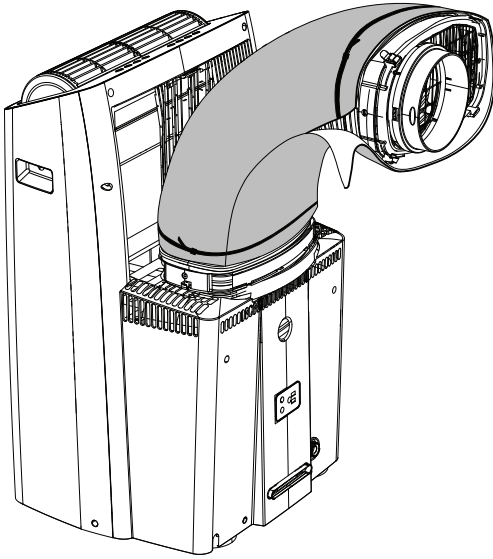

If you are experiencing condensation on the outer section of the hose during heating operation, apply the included heat pump insulation foam to the outside of the hose. Use the included zip ties to secure the foam around the hose.

REMOTE CONTROL AND APP INSTRUCTIONS

Handling the Remote Control

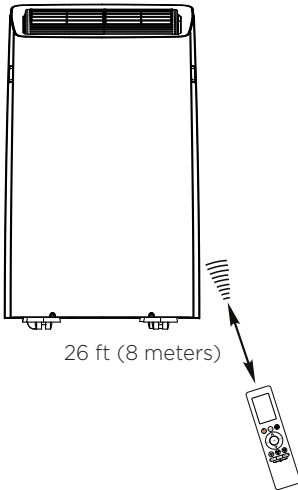

LOCATION OF THE REMOTE CONTROL

Use the remote control within a distance of 26 ft. (8m) from the air conditioner, pointing it towards the unit. The unit will beep when it receives a signal.

⚠ CAUTION

- The air conditioner will not operate if curtains, doors or other materials block the signals from the remote control to the unit.
- Prevent any liquid from spilling onto the remote control. Do not expose the remote control to direct sunlight or heat.
- If the infrared signal receiver on the indoor unit is exposed to direct sunlight, the air conditioner may not function properly. Use curtains to prevent the sunlight from falling on the receiver.
- If other electrical appliances react to the remote control, either move these appliances or consult your local dealer.

Inserting and Replacing Batteries

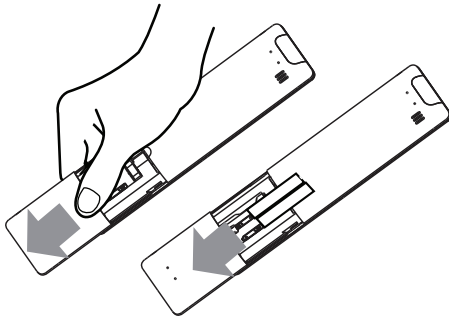

Your air conditioning unit may come with two batteries AAA (some units). Put the batteries in the remote control before use.

1. Slide the back cover from the remote control downward, exposing the battery compartment.
2. Insert the batteries, paying attention to match up the (+) and (-) ends of the batteries with the symbols inside the battery compartment.
3. Slide the battery cover back into place.

BATTERY NOTES

For optimum product performance:

- Do not mix old and new batteries, or batteries of different types.
- Do not leave batteries in the remote control if you don't plan on using the device for more than 2 months.

BATTERY DISPOSAL

Ensure used batteries are disposed of properly.

TIPS FOR USING REMOTE CONTROL

- In order to properly transmit a command, the ON/OFF indicator must be illuminated on the remote's display. (See the Remote LED Screen Indicators section for more information.)

Remote Control Specifications

Model	RG10F2(B2)/BGEFU1
Rated Voltage	3.0V (Dry batteries R03/LR03x2)
Signal Receiving Range	26 ft (8 m)
Environment	-5 °C ~ 60 °C (23°F ~ 140°F)

Function Buttons

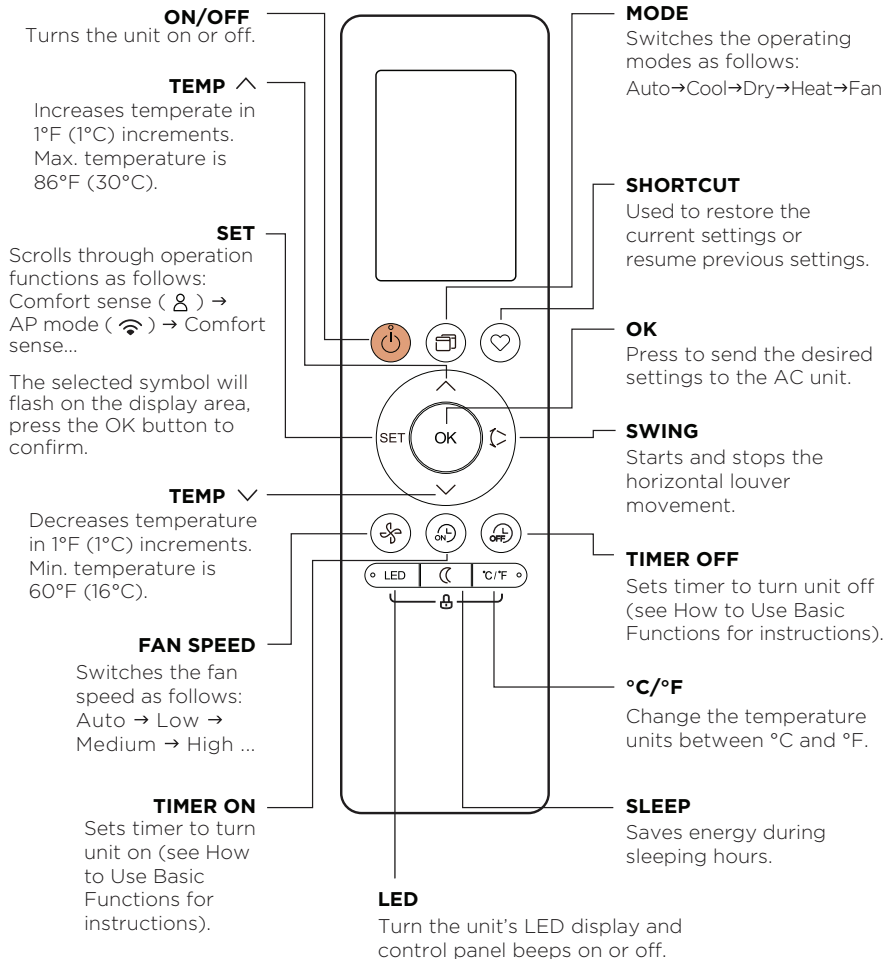

Remote Screen Indicators

Information is displayed when the remote control is powered on.

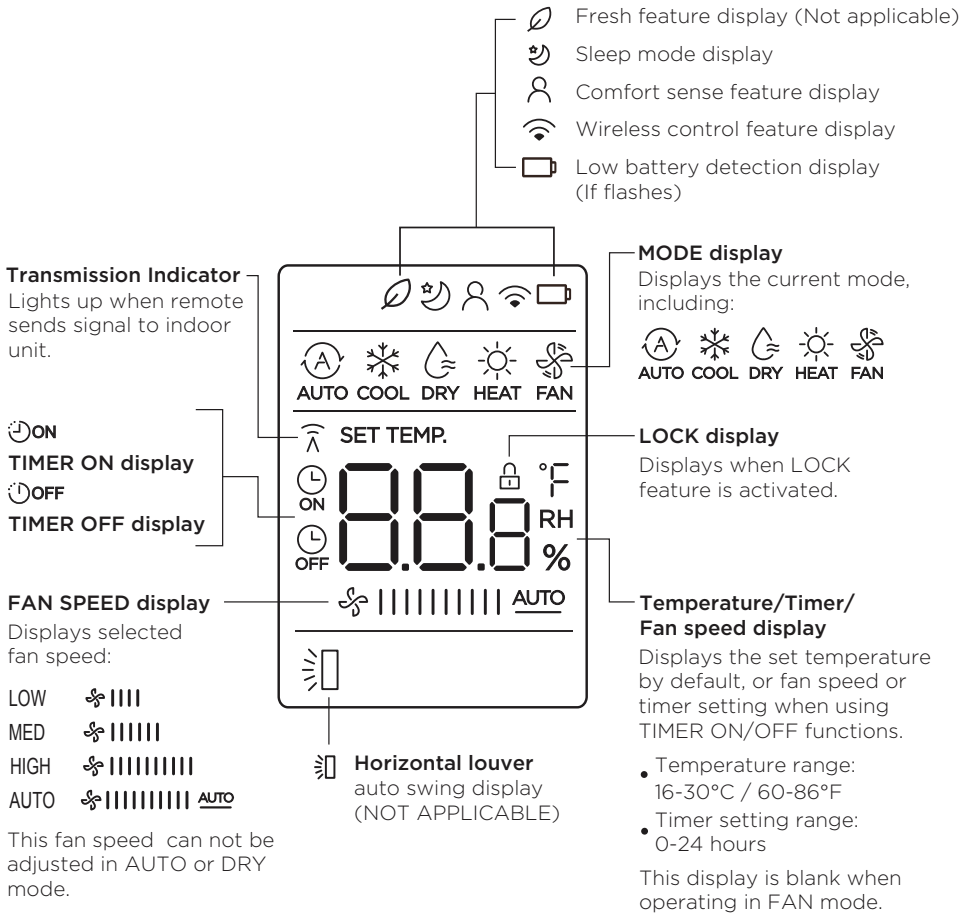

Setting the TIMER

TIMER ON/OFF - Set the amount of time after which the unit will automatically turn on/off.

TIMER ON SETTING

Press TIMER ON button to initiate the ON time sequence.

Press up or down button for multiple times to set the desired time to turn on the unit.

Point remote to unit and wait 1 sec, the TIMER ON will be activated.

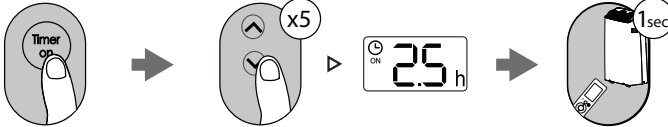

TIMER OFF SETTING

Press TIMER OFF button to initiate the OFF time sequence.

Press up or down button for multiple times to set the desired time to turn off the unit.

Point remote to unit and wait 1 sec, the TIMER OFF will be activated.

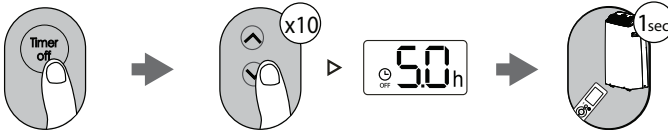

NOTICE

- When setting the TIMER ON or TIMER OFF, the time will increase by 30 minutes increments with each press, up to 10 hours. After 10 hours and up to 24, it will increase in 1 hour increments. (For example, press 5 times to get 2.5h, and press 10 times to get 5h,). The timer will revert to 0.0 after 24.
- Cancel either function by setting its timer to 0.0h.

TIMER ON & OFF SETTING (EXAMPLE)

Keep in mind that the time periods you set for both functions refer to hours after the current time.

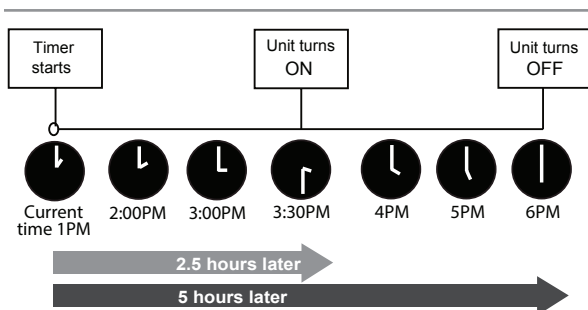
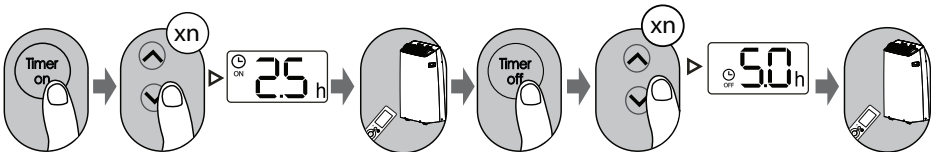

Example: If current timer is 1:00PM, to set the timer as above steps, the unit will turn on 2.5h later (3:30PM) and turn off at 6:00PM.

DECLARATION OF CONFORMITY

We hereby declare that this AC is in compliance with the essential requirements and other relevant provisions of Directive 1999/5/EC.

SPECIFICATION OF WIRELESS MODULE

Model: US-SK105	Dimensions: 41 x 24 x 5 (mm)
Standard: IEEE 802.11 b/g/n	Operation Temperature: 0°C - 45°C / 32°F - 113°F.
Antenna Type: Printed PCB Antenna	Operation Humidity: 10% - 85%
Frequency: 2400-2483.5MHz	Power Input: DC 5V/300 mA
Maximum Transmitted Power: <20 dBm Max	

PRECAUTIONS

1. Supports operating systems: iOS 7+ or Android 4+.
2. In the event of a OS update, there may be a delay between the update of the OS and a related software update during which your OS may or may not be supported until a new version is released. Your specific mobile phone or problems in your network may prevent the system from working and Midea will not be responsible for any problems that could be caused by incompatibility or network issues.
3. This Smart AC only supports WPA-PSK/WPA2-PSK (recommended) encryption.
4. To ensure proper scanning of the QR code, your smart phone must have at least a 5-megapixel camera.
5. Due to unstable network connectivity, requests may time out. If this happens, re-run the network configuration.
6. Due to unstable network connectivity, commands may time out. If this happens, the smartphone app and the actual product may display conflicting information. The information displayed on the actual product is always the most accurate available. Refresh the app to re-sync.

NOTICE

Midea will not be responsible for any problems that could be caused by incompatibility or network issues, your wireless router and mobile phone.

SYSTEM OVERVIEW

Devices required to use the Smart AC:

1. Smart Phone with compatible iOS or Android system.
2. Wireless Router (a 2.4GHz network is required to connect).
3. Smart Air Conditioner

DOWNLOAD AND INSTALL THE APP

Android QR code



Apple QR code



Scan to download app.

- You can also go to Google Play or App Store and search for Midea Air.

NOTICE

All the images in this manual are for reference only, your product and app may look slightly different. The actual product and app instructions have to be considered.

CREATE YOUR ACCOUNT

- Make sure your smartphone is connected to your wireless router and your wireless router has a working 2.4GHz internet connection.
- It is recommended to activate your account immediately to be able to recover your password by email.

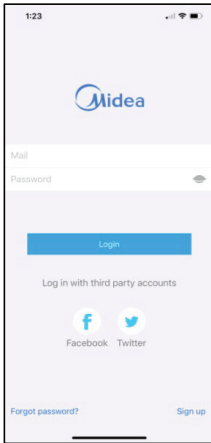

1. Press "Sign Up".

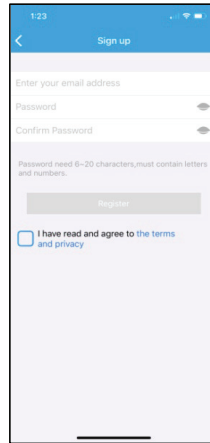

2. Enter your email address and password.

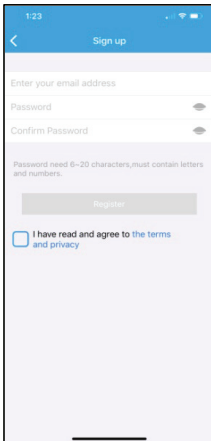

3. Press "Registration".

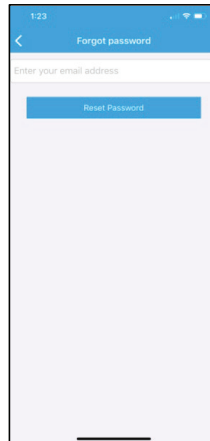

4. If you forget your password, press "Forgot password?" on the main menu and enter your email address. Then press "Reset Password".

NOTICE

- Make sure your smartphone is able to connect to the wireless network which will be used.
- Make sure also that the device is not connecting to other networks in range.

ADDITIONAL APP AND SMART HOME FUNCTIONS

For additional instructions regarding the features of the app and Smart Home skill capabilities, scan the QR code below.



WARRANTY

Air Conditioner Limited Warranty

Your product is protected by this Limited Warranty:

Warranty service must be obtained from Midea Consumer Services or an authorized Midea servicer.

Warranty

- One year full warranty from original purchase date.

Midea, through its authorized servicers will:

- Pay all costs for repairing or replacing parts of this appliance which prove to be defective in materials or workmanship.

Consumer will be responsible for:

- Diagnostics, removal, transportation and reinstallation cost required because of service.
- Costs of service calls that are a result of items listed under NORMAL RESPONSABILITIES OF THE CONSUMER**

Midea replacement parts shall be used and will be warranted only for the original warranty.

NORMAL RESPONSABILITIES OF THE CONSUMER**

This warranty applies only to products in ordinary household use, and the consumer is responsible for the items listed below:

1. Proper use of the appliance in accordance with instructions provided with the product.
2. Routine maintenance and cleaning necessary to keep the good working condition.
3. Proper installation by an authorized service professional in accordance with instructions provided with the appliance and in accordance with all local plumbing, electrical and/or gas codes.
4. Proper connection to a grounded power supply of sufficient voltage, replacement of blown fuses, repair of loosen connections or defects in house wiring.
5. Expenses for making the appliance accessible for servicing.
6. Damages to finish after installation.

EXCLUSIONS

This warranty does not cover the following:

- 1) Failure caused by damage to the unit while in your possession (other than damage caused by defect or malfunction), by its improper installation, or by unreasonable use of the unit, including without limitation, failure to provide reasonable and necessary maintenance or to follow the written installation and Operating Instructions.
- 2) Damages caused by services performed by persons other than those authorized by Midea customer service; or external causes such as abuse, misuse, inadequate power supply or acts of God.
- 3) If the unit is put to commercial, business, rental, or other use or application other than for consumer use, we make no warranties, express or implied, including but not limited to, any implied warranty of merchantability or fitness for use or purpose.
- 4) Products without original serial numbers or products that have serial numbers which have been altered or cannot be readily determined.

NOTICE: Some states do not allow the exclusions or limitation of incidental or consequential damages. So this limitation or exclusion may not apply to you.

IF YOU NEED SERVICE

Keep your bill of sale, delivery slip, or some other appropriate payment Record.

The date on the bill establishes the warranty period, should service be required.

If service is performed, its your best interest to obtain and keep all receipts.

This written warranty gives you specific legal rights. You may also have other rights that vary from state to state.

Service under this warranty must be obtained by following these steps, in order:

- 1) Contact Midea Consumer Services or an authorized Midea services at 1 866 646 4332.
- 2) If there is a question as to where to obtain service, contact our consumer relations Department.



WARNING: Chemical Burn Hazard. Keep batteries away from children.

This product contains a lithium button/coin cell battery. If a new or used lithium button/coin cell battery is swallowed or enters the body, it can cause severe internal burns and can lead to death in as little as 2 hours. Always completely secure the battery compartment. If the battery compartment does not close securely, stop using the product, remove the batteries, and keep it away from children. If you think batteries might have been swallowed or placed inside any part of the body, seek immediate medical attention.



make yourself at home