



# OWNER'S MANUAL

# DRYER

---

Read this owner's manual thoroughly before operating the appliance and keep it handy for reference at all times.

**ENGLISH**

DLHC1455\*



MFL71424396  
Rev.00\_022521

[www.lg.com](http://www.lg.com)

Copyright © 2021 LG Electronics Inc. All Rights Reserved.

## TABLE OF CONTENTS

### 3 IMPORTANT SAFETY INSTRUCTIONS

---

- 3 READ ALL INSTRUCTIONS BEFORE USE
- 3 WARNING STATEMENTS
- 6 CAUTION STATEMENTS

### 7 PRODUCT OVERVIEW

---

- 7 Product Features

### 9 INSTALLATION

---

- 9 Before Installing
- 10 Choosing the Proper Location
- 14 Leveling the Appliance
- 14 Reversing the Door
- 16 Stacking the Appliance
- 17 Connecting Electric Dryers
- 17 Special Electrical Requirements
- 18 Final Installation Check

### 19 OPERATION

---

- 19 Before Use
- 20 Loading the Dryer
- 21 Control Panel
- 23 Drying Cycles
- 26 Options and Extra Functions

### 29 SMART FUNCTIONS

---

- 29 LG ThinQ Application
- 31 Smart Diagnosis™ Function

### 33 MAINTENANCE

---

- 33 Regular Cleaning
- 35 Periodic Cleaning
- 37 Care in Cold Climates

### 39 TROUBLESHOOTING

---

- 39 FAQs
- 40 Before Calling for Service

### 44 WARRANTY

---

- 44 CANADA

# IMPORTANT SAFETY INSTRUCTIONS

## READ ALL INSTRUCTIONS BEFORE USE

### Safety Messages

**Your safety and the safety of others are very important.**

We have provided many important safety messages in this manual and on your appliance. Always read and follow all safety messages.



This is the safety alert symbol.

This symbol alerts you to potential hazards that can kill or injure you and others. All safety messages will follow the safety alert symbol and either the word **WARNING** or **CAUTION**.



#### **WARNING**

You may be killed or seriously injured if you do not follow instructions.



#### **CAUTION**

You may be injured or cause damage to the product if you do not follow instructions.

All safety messages will tell you what the potential hazard is, tell you how to reduce the chance of injury, and tell you what may happen if the instructions are not followed.

## WARNING STATEMENTS

### **WARNING**

- To reduce the risk of explosion, fire, death, electric shock, scalding or injury to persons when using this product, follow basic precautions, including the following:

### Installation

- Before use, the appliance must be properly installed as described in this manual.
- Connect to a properly rated, protected, and sized power circuit to avoid electrical overload.
- To reduce the risk of severe injury or death, follow all installation instructions.
- The appliance must be installed and electrically grounded by qualified service personnel in accordance with local codes.
- Disconnect the power cord, house fuse or circuit breaker before installing or servicing the appliance.
- When moving or installing the appliance in a different location, call qualified service personnel for installation and service.
- Keep packing materials out of the reach of children. Packaging material can be dangerous for children. There is a risk of suffocation.
- Moving or installation of the appliance requires two or more people.
- This appliance is not designed for maritime use or for mobile installations such as in RVs, trailers, or aircraft.
- This appliance must be positioned near to an electrical power supply.
- Do not, under any circumstances, cut or remove the third (ground) prong from the power cord.
- When installing or moving the appliance, be careful not to pinch, crush, or damage the power cord.
- Do not install the appliance in humid spaces.

## 4 IMPORTANT SAFETY INSTRUCTIONS

---

- Destroy the carton, plastic bag, and other packing materials after the appliance is unpacked. Children might use them for play. Cartons covered with rugs, bedspreads, or plastic sheets can become airtight chambers.
- Adhere to all industry recommended safety procedures including the use of long-sleeved gloves and safety glasses.
- Place the appliance at least 18 inches above the floor for a garage installation.
- Do not install near another heat source such as a stove, oven or heater.
- Keep area around the exhaust opening and adjacent surrounding areas free from the accumulation of lint, dust, and dirt.
- The appliance must not be supplied through an external switching device, such as a timer, or connected to a circuit that is regularly switched on and off by a utility.
- Certain internal parts are intentionally not grounded and may present a risk of electric shock only during servicing. Service personnel – Do not contact the following parts while the appliance is energized: Motor, Control Board, Noise Filter.

### Operation

- Never attempt to operate this appliance if it is damaged, malfunctioning, partially disassembled, or has missing or broken parts, including a damaged cord or plug.
- Repair or immediately replace all power cords that have become frayed or otherwise damaged. Do not use a cord that shows cracks or abrasion damage along its length or at either end.
- If you detect a strange sound, a chemical or burning smell, or smoke coming from the appliance, unplug it immediately, and contact an LG Electronics customer information center.
- Never unplug the appliance by pulling on the power cord. Always grip the plug firmly and pull straight out from the outlet.
- Do not use an extension cord or adapter with this appliance.
- Do not grasp the power cord or touch the appliance controls with wet hands.
- Do not modify or extend the power cord.
- If the appliance has been submerged, contact an LG Electronics customer information center for instructions before resuming use.
- Do not store or use gasoline or other flammable vapors and liquids in the vicinity of this or any other appliance.
- Keep the area underneath and around your appliances free of combustible materials (lint, paper, rags, etc.), gasoline, chemicals and other flammable vapors and liquids.
- This appliance is not intended for use by persons (including children) with reduced physical, sensory or mental capabilities, or lack of experience and knowledge, unless they have been given supervision or instruction concerning the use of the appliance by a person responsible for their safety.
- Use this appliance only for its intended purpose.
- Do not abuse, sit on, or stand on the door of the appliance.
- Do not allow children to play on, in or with the appliance. Close supervision of children is necessary when the appliance is used near children.
- Do not tamper with controls.
- Do not put oily or greasy clothing, candles or flammable materials on top of the appliance.
- Do not reach into the appliance if the drum is moving.
- Do not dry articles that have been previously cleaned in, washed in, soaked in, soiled with or spotted with gasoline, dry cleaning solvents, vegetable oil, cooking oil or other flammable or explosive substances, as they give off vapors that could ignite or explode.
- Do not use heat to dry articles containing foam rubber or similarly textured rubber-like materials.
- Do not store plastic, paper, or clothing that may burn or melt on top of the dryer during operation.

- Always check the inside of the appliance for foreign objects.
- Do not place items exposed to cooking oils in your dryer. Items contaminated with cooking oils may contribute to a chemical reaction that could cause a load to catch fire. To reduce the risk of fire due to contaminated loads, the final part of a tumble dryer cycle occurs without heat (cool down period). Avoid stopping a tumble dryer before the end of the drying cycle unless all items are quickly removed and spread out so that the heat is dissipated.
- Do not let children or pets climb inside the dryer drum.
- Do not put living animals such as pets inside the appliance.
- Do not put any part of your body, such as your hands or feet, or metal objects under the appliance.
- Do not let your hand get pinched when opening or closing the dryer door.

## Maintenance

- Do not repair or replace any part of the appliance. All repairs and servicing must be performed by qualified service personnel unless specifically recommended in this Owner's Manual. Use only authorized factory parts
- Do not disassemble or repair the appliance by yourself.
- Remove any dust or foreign matter from the power plug pins.
- Disconnect this appliance from the power supply before cleaning and attempting any user maintenance. Turning the controls to the OFF position does not disconnect this appliance from the power supply.
- Remove the door before the appliance is removed from service or discarded to avoid the danger of children or small animals getting trapped inside.
- Unplug the appliance before cleaning to avoid the risk of electric shock.
- Certain internal parts are intentionally not grounded and may present a risk of electric shock only during servicing. Service personnel – Do not contact the following parts while the appliance is energized: Motor, Control Board, Noise Filter.

## Grounding Instructions

- Improper connection of the equipment-grounding conductor can result in a risk of electric shock. Check with a qualified electrician or service personnel if you are in doubt whether the appliance is properly grounded. Do not modify the plug provided with the appliance; if it will not fit the outlet, have a proper outlet installed by a qualified electrician.
- The appliance must be grounded. In the event of a malfunction or breakdown, grounding will reduce the risk of electric shock by providing a path of least resistance for electric current. The appliance is equipped with a cord having an equipment-grounding conductor and a grounding plug. The plug must be plugged into an appropriate outlet that is installed and grounded in accordance with all local codes and ordinances.
- The appliance must be plugged into a properly grounded outlet. Electrical shock may result if the appliance is not properly grounded. Have the wall outlet and circuit checked by a qualified electrician to make sure the outlet is properly grounded. Failure to follow these instructions may create an electric shock hazard and/or a fire hazard.

## CAUTION STATEMENTS

---

### CAUTION

- To reduce the risk of minor or moderate injury to persons, malfunction, or damage to the product or property when using this product, follow basic precautions, including the following:
- 

### **Installation**

- Install the appliance on a firm and level floor.
- Store and install the appliance where it will not be exposed to temperatures below freezing or exposed to outdoor weather conditions.

### **Operation**

- Clean the lint filter before or after each load.
- Do not use fabric softeners or products to eliminate static unless recommended by the manufacturer of the fabric softener or product.
- If the drain hose is frozen in winter, thaw it out before use.

**SAVE THESE INSTRUCTIONS**

# PRODUCT OVERVIEW

## Product Features

The images in this guide may be different from the actual components and accessories, which are subject to change by the manufacturer without prior notice for product improvement purposes.

### Front View

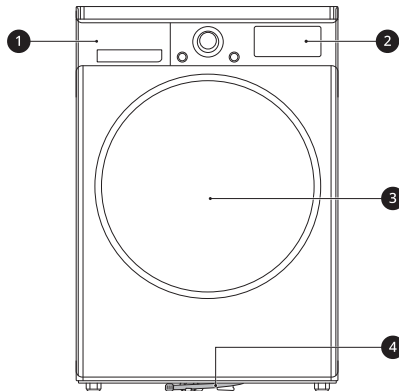

- ❶ Water Container
- ❷ Control Panel
- ❸ Door
- ❹ Drain Tube

### Rear View

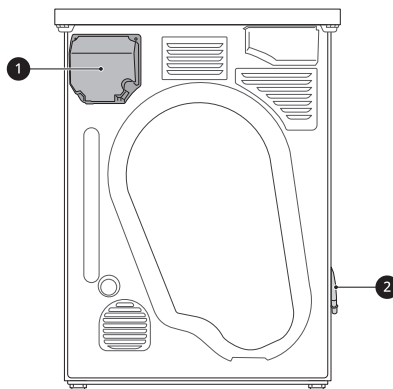

- ❶ Terminal Block Cover
- ❷ External drainage of condensed water

## Product Specifications

The appearance and specifications listed in this manual may vary due to constant product improvements.

**Electrical requirements:** Please refer to the rating label for detailed information.

Model		DLHC1455*
Description		Heat Pump Electric Dryer
Dimensions (Width × Depth × Height)		24" x 26 3/8" x 33 1/2", 45 1/4" (Depth with door open) 60 cm x 67 cm x 85 cm, 115 cm (Depth with door open)
Net Weight		127.9 lb (58 kg)
Drying Capacity	<b>Normal Cycle</b>	IEC 4.2 cu.ft (19.8 lb/9 kg)

### NOTE

- Model numbers can be found on the cabinet inside the door.

## Accessories

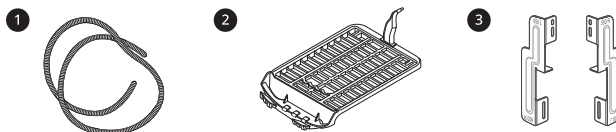

- ❶ Drain hose
- ❷ Drying rack (sold separately)
- ❸ Stacking kit

### NOTE

- For your safety and extended product life, use only authorized components. The manufacturer is not responsible for product malfunction or accidents caused by the use of unauthorized components or parts.



# INSTALLATION

## Before Installing

### Installation Overview

Please read the following installation instructions first after purchasing this dryer or transporting it to another location.

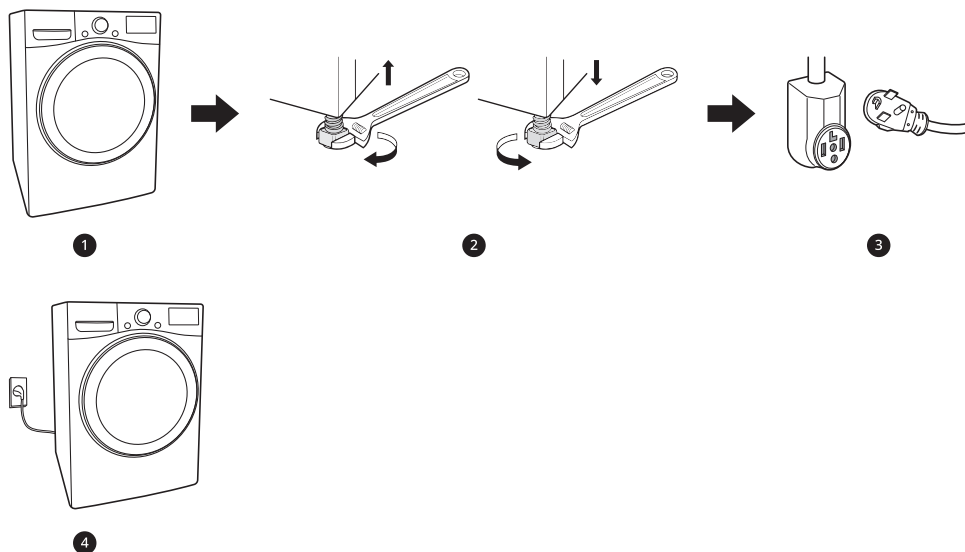

- 1 Choosing the Proper Location
- 2 Leveling the Appliance
- 3 Connecting the Power Cord
- 4 Final Installation Check

## Choosing the Proper Location

### ⚠ WARNING

- Read all installation instructions completely before installing and operating the appliance. It is important that you review this entire manual before installing and using the appliance. Detailed instructions concerning electrical connections and additional requirements are provided on the following pages.

### Electricity

Use an individual, grounded electrical outlet located within 2 ft. (61 cm) of either side of the appliance.

### ⚠ WARNING

- Do not install or store the appliance in an area where it will be exposed to water and/or weather.

### NOTE

- Check code requirements that limit, or do not permit, installation of the dryer in garages, mobile homes or sleeping quarters. Contact your local building inspector.

### Flooring

To avoid noise and vibration, the appliance must be installed and leveled on a solidly constructed floor with a maximum slope of 1 inch (2.5 cm). If required, adjust the leveling legs to compensate for the unevenness of the floor.

### NOTE

- A sturdy floor is needed to support the total appliance weight when loaded. The combined weight of a companion appliance should also be considered.
- Clothes may not tumble properly, and automatic sensor cycles may not operate correctly if the appliance is not level.
- Far garage installation, you will need to place the appliance at least 18 inches (45.7 cm) above the floor. The standard pedestal height is 15 inches

(38 cm). You will need 18 inches (45.7 cm) from the garage floor to the bottom of the appliance.

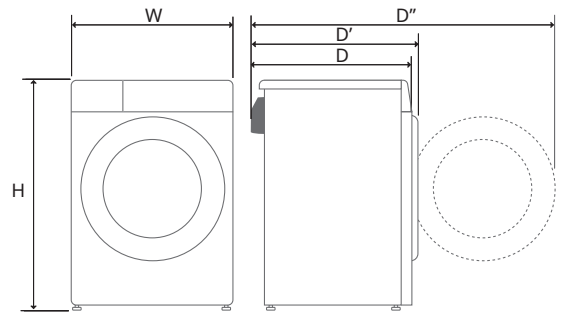

Dimensions	
W	24" (60 cm)
H	33 1/2" (85 cm)
D	25 1/4" (64 cm)
D'	26 3/8" (67 cm)
D''	45 1/4" (115 cm)

### Ambient Temperature

Install the appliance in an area where the temperature is over 45 °F (7 °C).

If the temperature around the appliance is too low, the appliance might not shut off at the end of an automatic cycle. This can result in longer drying times.

## Dimensions and Clearances

The following clearances are recommended for the appliance.

- Additional clearances should be considered for ease of installation and servicing.
- Additional clearances should be considered on all sides of the dryer to reduce noise transfer.

### Installation spacing for Recessed Area or Closet Installation

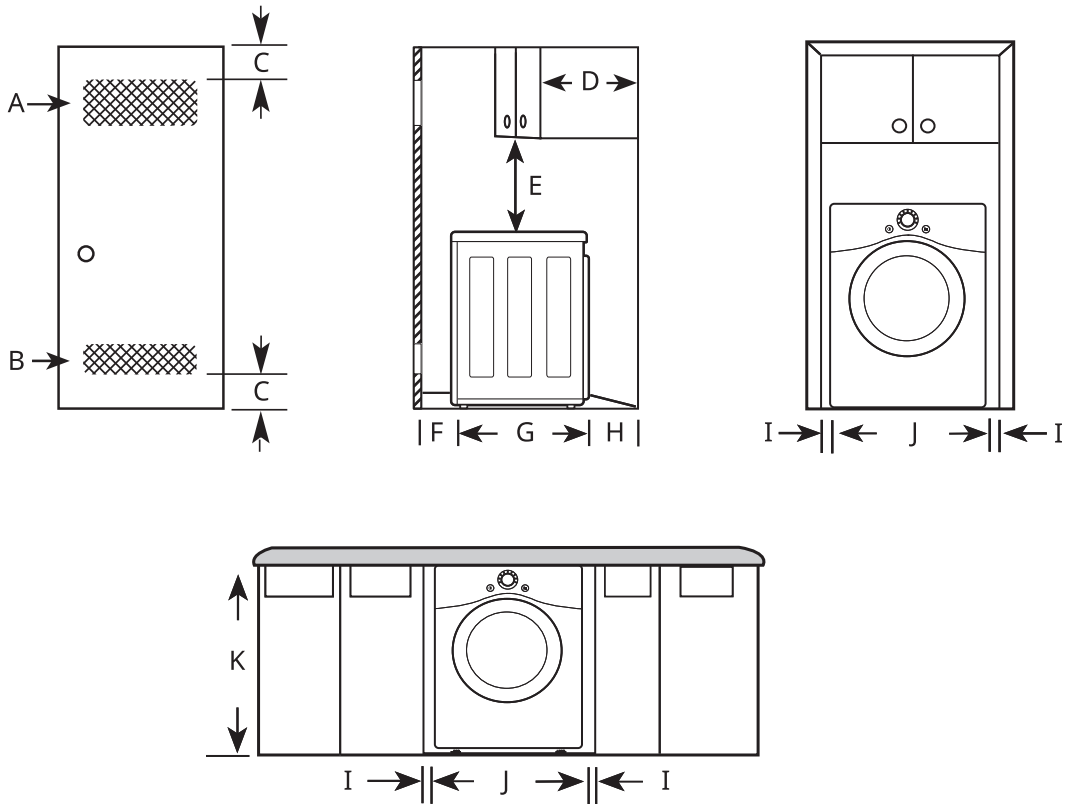

-	Description	Dimension/Clearance
A	Upper Ventilation Opening	≥ 48 sq. in. (310 cm <sup>2</sup> )
B	Lower Ventilation Opening	≥ 24 sq. in. (155 cm <sup>2</sup> )
C	Distance to Ventilation Opening	≥ 3" (76 mm)
D	Overhead Cabinet Depth	≤ 14" (356 mm)
E	Distance to the Overhead Cabinet/Shelf	≥ 18" (457 mm)
F	Front Clearance	1" (25 mm)
G	Depth	26 3/8" (670 mm)
H	Back Clearance	≥ 5" (127 mm)
I	Side Clearance	≥ 1" (25 mm)
J	Width	24" (600 mm)
K	Height of Cabinet Opening	33 1/2" (850 mm)

### Closet Ventilation Requirements

Closets with doors must have both an upper and lower vent to prevent heat and moisture buildup in the closet. One upper vent opening with a minimum opening of 48 sq. in. (310 cm<sup>2</sup>) must be installed no lower than 6 feet above the floor. One lower vent opening with a minimum opening of 24 sq. in. (155 cm<sup>2</sup>) must be installed no more than one foot above the floor. Install vent grills in the door or cut down the door at the top and bottom to form openings. Louvered doors with equivalent ventilation openings are also acceptable.

### NOTE

- There should be at least a little space around the dryer (or any other appliance) to eliminate the transfer of vibration from one appliance to another. If there is enough vibration, it could cause appliances to make noise or come into contact, causing paint damage and further increasing noise.
- No other fuel-burning appliance can be installed in the same closet as a dryer.

### Installation Spacing for Recessed Area or Closet, with Stacked Washer and Dryer

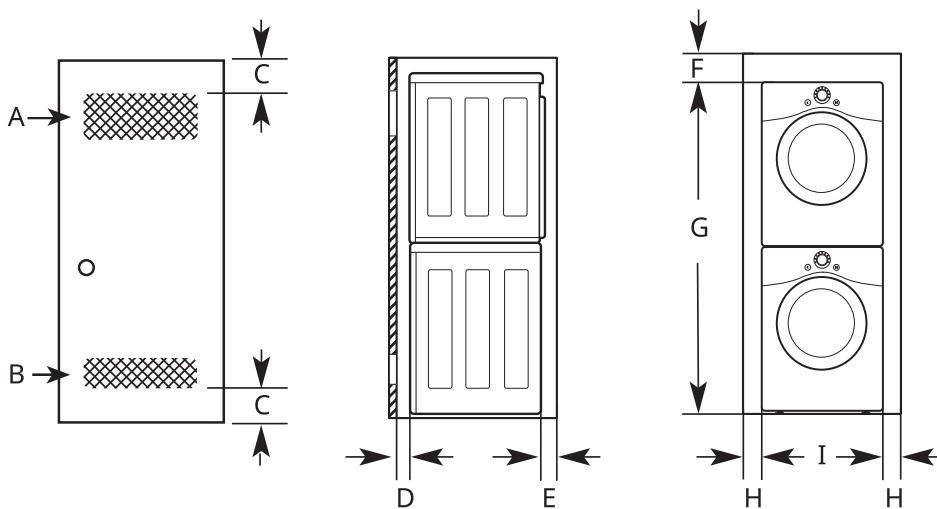

-	Description	Dimension/Clearance
A	Upper Ventilation Opening	≥ 48 sq. in. (310 cm <sup>2</sup> )
B	Lower Ventilation Opening	≥ 24 sq. in. (155 cm <sup>2</sup> )
C	Distance to Ventilation Opening	≥ 3" (76 mm)
D	Front Clearance	≥ 1" (25 mm)
E	Back Clearance	≥ 5 1/2" (140 mm)
F	Top Clearance to the Ceiling	≥ 6" (152 mm)
G	Height to the Top of Stacked Appliances <sup>†</sup>	67" (1700 mm)
H	Side Clearance	≥ 1" (25 mm)
I	Width <sup>†</sup>	24" (600 mm)

<sup>†</sup> Differs depending on the washer dimensions.

### Installation Spacing for Cabinet

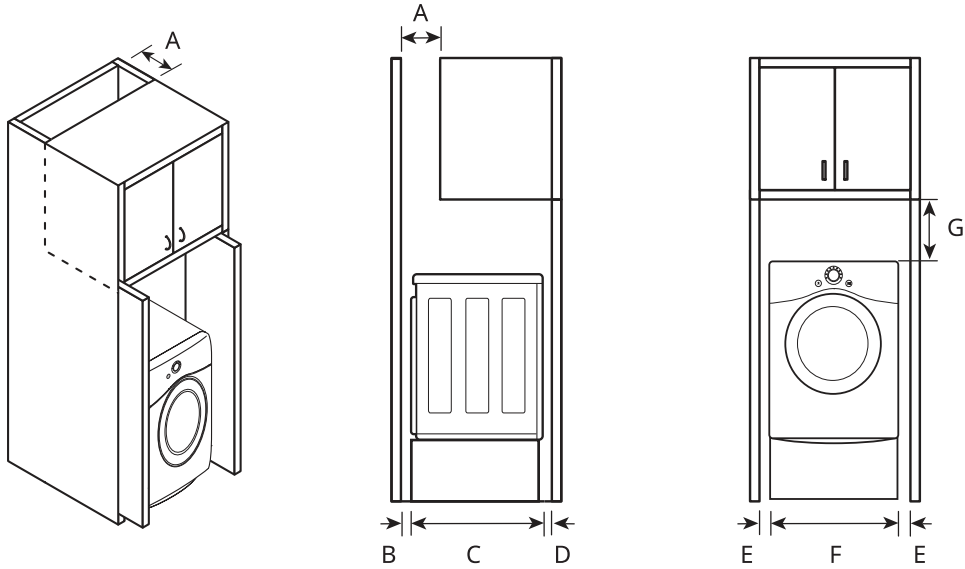

For cabinet installation with a door, minimum ventilation openings in the top of the cabinet are required.

-	Description	Dimension/Clearance
A	Depth of Ventilation Opening	≥ 7" (178 mm)
B	Back Clearance	≥ 5" (127 mm)
C	Depth	26 3/8" (670 mm)
D	Front Clearance	≥ 1" (25mm)
E	Side Clearance	≥ 1" (25 mm)
F	Width	24" (600 mm)
G	Clearance to Top of Cabinet	≥ 9" (229 mm)

## Leveling the Appliance

### ⚠ WARNING

- Use long-sleeved gloves and safety glasses.
- The appliance is heavy. Two or more people are required when installing the appliance.

### Checking the Level

Position the appliance in the final location and place a level across the top of the appliance.

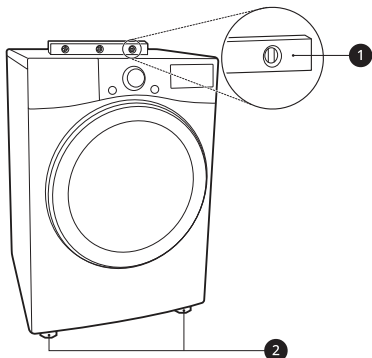

- ① Level
- ② Leveling Feet

### NOTE

- All four leveling feet must rest solidly on the floor. Gently push on the top corners of the appliance to make sure that the appliance does not rock from corner to corner.
- Adjust the leveling feet only as far as necessary to level the appliance. Extending the leveling feet more than necessary may cause the appliance to vibrate.
- To ensure that the appliance provides optimal drying performance, it must be level. To minimize vibration, noise, and unwanted movement, the floor must be a perfectly level, solid surface.

### Adjusting the Leveling Feet

Use an adjustable wrench to turn the leveling feet. Unscrew the legs to raise the appliance or screw in the legs to lower it. Raise or lower with the leveling feet until the appliance is level from side to side

and front to back. Make sure that all four leveling feet are in firm contact with the floor.

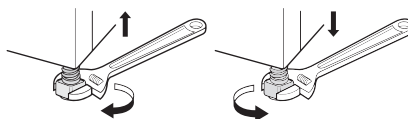

### NOTE

- If you are installing the appliance on the optional pedestal, you must use the leveling feet on the pedestal to level the appliance. The appliance leveling feet should be fully retracted.

## Reversing the Door

### ⚠ WARNING

- Support the door with a stool or box that fits under the door, or have an assistant support the weight of the door.
- Avoid dropping the door.
- Unplug the appliance or turn off power at the main circuit breaker before beginning door reversal.
- Always reverse the door BEFORE stacking the appliance on top of the washer.

### Tools Required

- Phillips screwdriver
- Large flat blade screwdriver (recommended for hinge screws if they are tight or your Phillips screwdriver is worn)
- Small flat blade screwdriver (for lifting out parts)

### Door Reversal Instructions

The instructions here are for changing the door swing from a right to a left side hinge. If the door has been reversed, and it is necessary to change it back, use care when following these instructions. Some of the illustrations and the left/right references will be reversed, and you will need to read the instructions carefully.

### ⚠ WARNING

- Do not reverse the door while the appliance is stacked on a washing machine.
- Before removing the hinge screws, have an assistant support the weight of the door. The door could fall on the floor due to the weight of the door.

- For safety reasons, two or more people need to work together to reverse the door.

**NOTE**

- The appearance of the screws varies and the screws must be inserted differently depending on the position. Make sure that you've selected the correct screw before tightening.

- 1 Open the door and remove 2 screws on the door hinge ①. Remove the door from the cabinet ② and place it inside facing up on a non-scratching surface.

**⚠ WARNING**

- Be sure to support the weight of the door before removing the hinge screws.

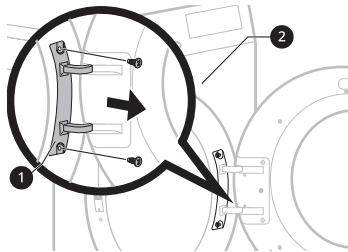

- 2 Remove 8 screws and remove the hinge assembly ③ from the door.
  - There are 6 screws on the front and 2 screws on the side.

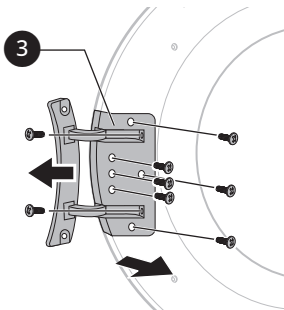

- 3 Remove the 3 screws from the door latch assembly ④ which is mounted between the door and the hinge assembly. Remove the screw in the door latch.

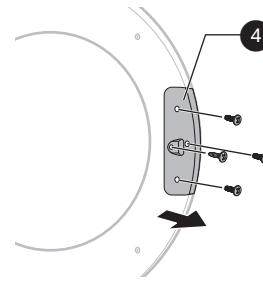

- 4 Swap the position of the hinge assembly ③ and the door latch assembly ④ and reassemble. Refer to steps 2 and 3 for the location and number of screws when reassembling.

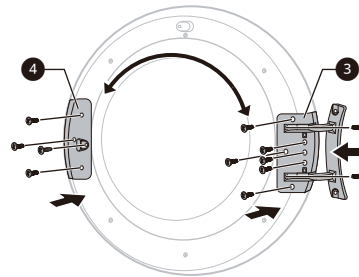

- 5 On the appliance cabinet, unscrew 2 screws and remove the door catch ⑤. Reassemble it on the opposite side of the door.

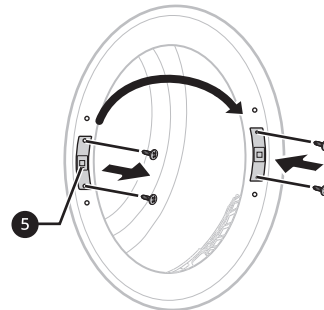

- 6 Remove the 2 decorative screws from the appliance cabinet and insert them on the opposite side.

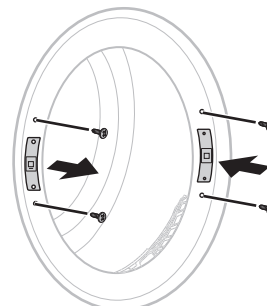

- 7 Reassemble the door on the cabinet using the screws removed in step 1. Make sure that the door opens, closes and latches properly.

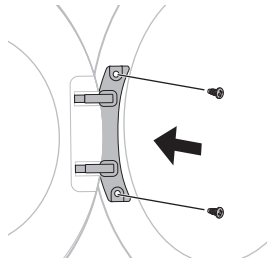

## Stacking the Appliance

### Stacking Kit Overview

In order to stack the appliance, an LG stacking kit is required.

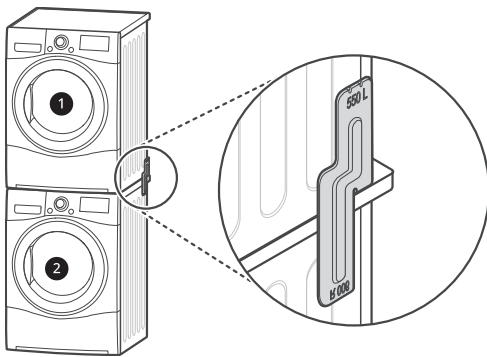

- 1 Dryer
- 2 LG Front Load Washing Machine

The appliance may only be stacked on top of an LG front load washing machine. Do not attempt to stack the appliance on any other washing machine, as it could result in damage, injury or property damage.

Shape and assembly direction	Washing Machine Top plate size	
	21 7/8 inch (550 mm)	24 inch (600 mm)

### Tools Required

- Phillips screwdriver

## Stacking Kit Installation

### ⚠ WARNING

- The weight of the appliance and the height of installation make this stacking procedure too risky for one person. Two or more people are required when installing the stacking kit.
- Place the washer on a solid, stable, level floor capable of supporting the weight of both appliances.
- Do not stack the washer on top of the dryer.
- If appliances are already installed, disconnect them from all power, water, and drainage connections.

- 1 Place the appliance on the top of an LG front load washing machine.
- 2 Remove the 1 screw from the bottom of the rear cover on each side.

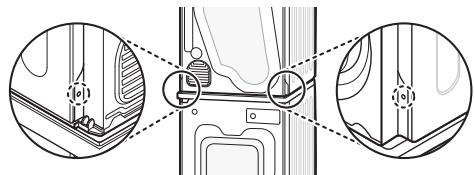

- 3 Align the hole in the bracket with the hole in the rear cover of the appliances.

- If using the 24" (600 mm) top plate:

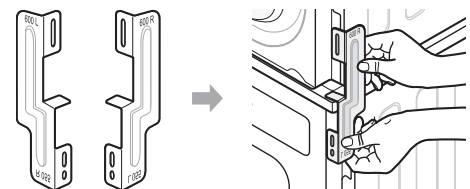

- If using the 21 7/8" (550 mm) top plate:

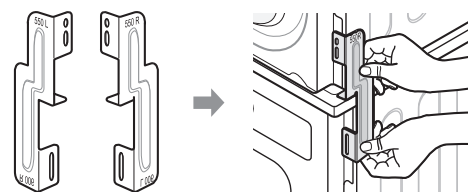

- 4 Use the 2 screws removed earlier to hold the stacking brackets in place on each side.
- 5 Use the four 0.6" (16 mm) screws provided in the accessory box to secure the brackets in place.



## Installing the Optional Drain Hose

Normally, condensed water is pumped up to the water container where water is collected until manually emptied. It may be more convenient to drain water to an external drain, especially when the appliance is stacked on top of a washing machine.

Use the connecting T piece to reroute the drainage as shown below.

- 1 Remove the anti-backflow cap ❶ and disconnect the water container hose ❷ from the T piece.

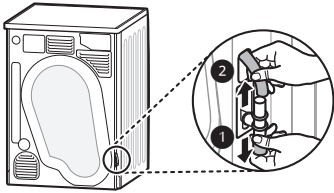

- 2 Attach the anti-backflow cap ❶ to the top of the T piece and connect the optional drain hose ❸ to the bottom of the T piece.

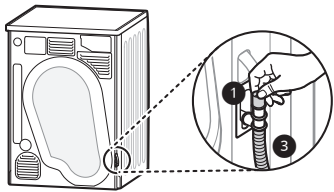

### ⚠ CAUTION

- If the drain hose is kinked or pinched, it will not drain properly.

## Connecting Electric Dryers

To reduce the risk of fire or explosion, electric shock, property damage, injury to persons, or death when using this appliance, fulfill the following requirements.

### Electrical Requirements

- The wiring and grounding must conform to the latest edition of the National Electrical Code, ANSI/NFPA 70 and all applicable local regulations. Please contact a qualified electrician to check your home's wiring and fuses to ensure that your home has adequate electrical power to operate the dryer.
- This dryer must be connected to a grounded metal, permanent wiring system, or an equipment-grounding conductor must be run with the circuit conductors and connected to the

equipment-grounding terminal or lead on the dryer.

- The dryer has its own terminal block that must be connected to a separate 240 VAC, 60-Hertz, single-phase circuit, fused at 30 amperes (the circuit must be fused on both sides of the line). ELECTRICAL SERVICE FOR THE DRYER SHOULD BE OF THE MAXIMUM RATE VOLTAGE LISTED ON THE NAMEPLATE. DO NOT CONNECT THE DRYER TO 110-, 115-, OR 120-VOLT CIRCUIT.
- If the branch circuit to dryer is 15 ft. (4.5 m) or less in length, use UL (Underwriters Laboratories) listed No.-10 AWG wire (copper wire only), or as required by local codes. If over 15 ft. (4.5 m), use UL-listed No.-8 AWG wire (copper wire only), or as required by local codes. Allow sufficient slack in wiring so the dryer can be moved from its normal location when necessary.
- The power cord (pigtail) connection between the wall receptacle and the dryer terminal block IS NOT supplied with the dryer. Type of pigtail and gauge of wire must conform to local codes and with instructions on the following pages.
- Do not modify the plug and internal wire provided with the dryer.
- The dryer should be connected to a 4-hole outlet.
- If the plug does not fit the outlet, a proper outlet will need to be installed by a qualified electrician.
- Connect the power cord to the terminal block. Each colored wire should be connected to the same color screw. Wire color indicated on manual is connected to the same color screw in the block.
- Grounding through the neutral conductor is prohibited for: (1) new branch-circuit installations and (2) areas where local codes prohibit grounding through the neutral conductor.
- This dryer is supplied with the neutral wire grounded. This white ground wire MUST BE MOVED to the neutral terminal when a 4-wire cord is to be used, or where grounding through the neutral conductor is prohibited.

## Special Electrical Requirements

### For Mobile or Manufactured Homes

- Any installation in a manufactured or mobile home must comply with the Manufactured Home Construction and Safety Standards Title

24 CFR, Part 3280 or Standard CAN/ CSA Z240 MH and local codes and ordinances. If you are uncertain whether your proposed installation will comply with these standards, please contact a service and installation professional for assistance.

- A 4-wire connection is required for all mobile and manufactured home installations, as well as all new construction after January 1, 1996.
- The electrical connection for an electric dryer must be a 4-wire connection. More detailed information concerning the electrical connection is provided in the section Connecting Electric Dryers.
- To reduce the risk of combustion and fire, the dryer must be vented to the outside.
- DO NOT vent the dryer under a manufactured home or mobile home.
- Electric dryers may be vented to the outside using the back, left, right, or bottom panel.
- Make sure the dryer has adequate access to outside fresh air to ensure proper operation. The opening for outside fresh air must be at least 25 sq. in (163 cm<sup>2</sup>).
- Please be aware that venting materials are not supplied with the dryer. You must obtain the venting materials necessary for proper installation.

## Final Installation Check

Once you have completed the installation of the dryer and it is in its final location, confirm proper operation with the following tests.

### Checking Levelness

Once the dryer is in its final location, recheck the dryer to be sure it is level. Make sure it is level front to back and side to side, and that all four leveling feet are in firm contact with the floor.

# OPERATION

## Before Use

### ⚠ WARNING

- To reduce the risk of fire, electric shock, or injury to persons, read the **IMPORTANT SAFETY INSTRUCTIONS** before operating this appliance.

### Operation Overview

- 1 Ensure the lint filter and water container are clean.
  - Open the door and ensure the lint filter is clean. When the filter is full with lint, drying times will be longer than usual.
  - Pull out the water container and empty the condensed water. When the water container is full, the appliance may stop during the cycle.

### NOTE

- In some cases, the  icon may appear on the control panel to indicate that the water container needs to be emptied.

- 2 Place the clothes into the drum after sorting and close the door.
  - Make sure that clothing is pushed entirely into the drum and away from the door seal area. Clothing that gets stuck between the door and seal may be damaged or damage the seal.
  - Clothes should be sorted by fabric types and desired dryness level.
  - All strings and attached belts of clothes should be well tied and secured before being put into the drum.
- 3 Press the **Power** button to turn the appliance on.
  - Depending on the model, the **Power** button may light up to indicate that the appliance is ready to dry.
- 4 Choose a drying cycle by turning the cycle selector knob.
  - If you press the **Start/Pause** button without choosing a cycle, the appliance will proceed with the **Normal** cycle. Please refer to the cycle table for detailed information.

- 5 Press the **Start/Pause** button to start the drying cycle.

- 6 After the drying cycle has finished, open the door and unload the clothes.

### ⚠ CAUTION

- Be careful! The drum inside may still be hot.

- 7 Press the **Power** button to turn the appliance off.

- 8 Clean the lint filter and empty the water container.

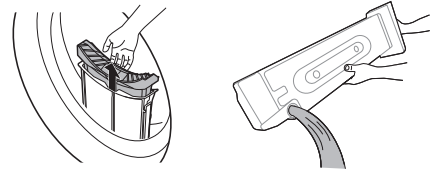

- 9 To help prevent odors, leave the dryer door slightly open to help air out the drum after use.

### ⚠ WARNING

- For safety, do not allow children or animals to climb inside the appliance. They could be injured or damage the appliance.

### NOTE

- The final part of the dry cycle does not use heat. This cool down period helps prevent damage to clothing.
- A high ambient temperature and a small room may both increase drying time as well as energy consumption.

## Loading the Dryer

### NOTE

- Do not overload the appliance for the best drying performance and most efficient energy usage.

### General Tips

- Combine large and small items in the same load.
- Close zippers, hooks and drawstrings to prevent these items from snagging or tangling on other clothes.

### NOTE

- Damp clothes will expand as they dry. Do not overload the dryer; clothes require room to tumble and dry properly.

### Grouping Similar Items

For the best drying results, and to reduce the possibility of damage to clothing, sort clothes into loads that can be dried with the same drying cycle.

Different fabrics have different care requirements, and some fabrics will dry more quickly than others.

### Woolen Items

- Always follow fabric care labels before drying woolen items in a dryer. After the cycle, the items may still be damp. Do not repeat the cycle. Pull the items to their original shape if needed and lay them flat to finish drying.

### Woven and Loopknit Materials

- Some woven and loopknit materials may shrink, depending on quality.

### Permanent Press and Synthetics

- Do not overload your dryer. Take out permanent press items as soon as the dryer stops to reduce wrinkles.

### Baby Clothes and Nightgowns

- Always check the manufacturer's instructions.

### Rubber and Plastics

- Do not dry any items made from or containing rubber or plastics such as:
  - Aprons, bibs and chair covers
  - Curtains and tablecloths
  - Bath mats

### Fiberglass







- Do not dry fiberglass articles in your dryer. Glass particles left in the dryer could be picked up by your clothes the next time you use the dryer and irritate your skin.





### Fabric Care Labels

- Sort and dry laundry according to care labels, size, and fabric type. Do not overload the dryer. This will save energy and time and give the best drying performance.

### Fabric Care Labels

Many articles of clothing include a fabric care label. Using the chart below, adjust the cycle and option selections to care for your clothing according to the manufacturer's recommendations.

Tumble Dry	
Label	Directions
	Dry
	Normal
	Permanent Press / Wrinkle Resistant
	Gentle / Delicate
	Do not tumble dry
	Do not dry (used with do not wash)

Heat Setting	
Label	Directions
	High
	Medium
	Low
	No Heat / Air

# Control Panel

## Control Panel Features

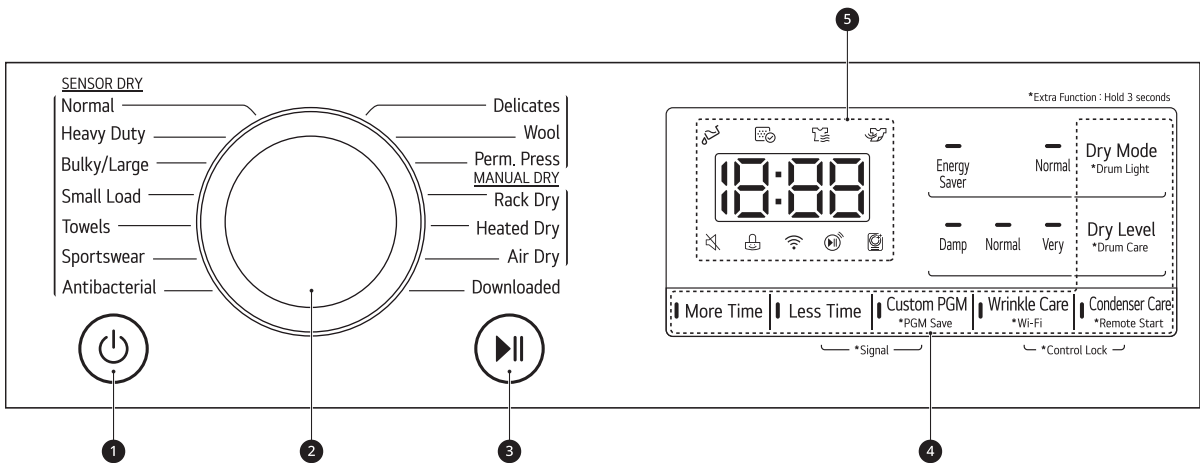

### 1 Power Button

- Press the button to turn the appliance on. Press again to turn the appliance off.

### NOTE

- Pressing the **Power** button during a cycle will cancel that cycle and any load settings will be lost.

### 2 Cycle Selector Knob

- Turn this knob to select the desired cycle. Once the desired cycle has been selected, the standard presets will be shown in the display. On Manual Dry cycles, these settings can be adjusted using the cycle modifier buttons anytime before starting the cycle.

### 3 Start/Pause Button

- Press this button to start the selected cycle. If the appliance is running, use this button to pause the cycle without losing the current settings.

### NOTE

- If you do not press the **Start/Pause** button to resume a cycle within a certain time, the appliance turns off automatically and all cycle settings are lost.

### 4 Extra Options and Functions / Cycle Modifier Buttons

- Use these buttons to select the desired options for the selected cycle. Not all options are available for each cycle.
- **Remote Start**
  - With the **LG ThinQ** app, you can use a smartphone to control your appliance remotely.
- **Wi-Fi**
  - Press and hold the **Wrinkle Care** button for 3 seconds to initiate the connection of the appliance to the **LG ThinQ** application.

### 5 Time and Status Display

- The display shows the settings, estimated time remaining, options, and status messages for the appliance. When the appliance is turned on, the default settings in the display will illuminate.

## Time and Status Display

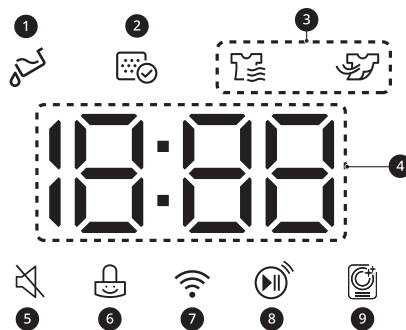



### 1 Water Full Indicator

-  lights up at the beginning of a cycle to remind you to empty the water container before drying. It also lights up when the water container is full and needs to be emptied.

### 2 Lint Filter Status Indicator

-  lights up at the beginning of the cycle to remind you to check the lint filter. It also lights up if the lint filter needs to be cleaned or is missing.
  - If the lint filter is not inserted, the icon will light up and the appliance will not operate.

### 3 Cycle Status Indicators

-  lights up when the appliance is in the drying stage.
-  lights up when the appliance is in the cool down stage. After  lights up, the appliance can operate for up to 20 minutes.

### 4 Estimated Time Remaining

- When a drying cycle is selected, the estimated drying time for the selected cycle is displayed. This time will change if you select extra options for the cycle.
- The cycle time on Sensor Dry cycles may fluctuate as the appliance recalculates drying time for optimal results.

- 5  lights up when the button and end-of-cycle sounds are turned off.

- 6  lights up when the control panel is locked.

- 7  lights up when the appliance is connected to Wi-Fi network at home.

- 8  lights up when the remote control feature is activated.

- 9  lights up while the **Drum Care** function is operating.

## Drying Cycles

Turn the knob or press the button to select the desired cycle. When you select a drying cycle the light for the corresponding drying cycle will turn on.

### Sensor Dry Cycles

Sensor dry cycles utilize LG's unique dual sensor system to detect and compare the moisture level in clothes and in the air and adjust the drying time as needed to ensure superior results. The appliance automatically sets the dryness level and temperature at the recommended setting for each cycle. The estimated time remaining will be shown in the display.

Cycle	Normal	
<b>Description</b>	Use this cycle for drying all normal items such as cotton, linen, shirts, jeans or mixed loads, except delicate fabrics such as wool or silk.	
<b>Dry Level</b>	Default: <b>Normal</b>	Available: <b>All</b>
<b>Dry Mode</b>	Default: <b>Energy Saver</b>	Available: <b>All</b>

Cycle	Heavy Duty	
<b>Description</b>	Use this cycle for drying heavy-duty clothes like jeans or garments that need extra drying.	
<b>Dry Level</b>	Not adjustable	
<b>Dry Mode</b>	Default: <b>Energy Saver</b>	Available: <b>Energy Saver</b>

Cycle	Bulky/Large	
<b>Description</b>	Use this cycle for drying blankets or bulky items such as pillows, blankets, comforters, sheets or pet bedding.	
<b>Dry Level</b>	Not adjustable	
<b>Dry Mode</b>	Default: <b>Normal</b>	Available: <b>Normal</b>

Cycle	Small Load	
<b>Description</b>	Use this cycle for drying light or small items. (up to 3 items)	
<b>Dry Level</b>	Not adjustable	
<b>Dry Mode</b>	Default: <b>Normal</b>	Available: <b>Normal</b>

Cycle	Towels	
<b>Description</b>	Use this cycle for drying towels.	
<b>Dry Level</b>	Not adjustable	
<b>Dry Mode</b>	Default: <b>Energy Saver</b>	Available: <b>Energy Saver</b>

Cycle	Sportswear	
<b>Description</b>	Use this cycle for drying special garments for sports and outdoor wear.	
<b>Dry Level</b>	Not adjustable	
<b>Dry Mode</b>	Default: <b>Energy Saver</b>	Available: <b>Energy Saver</b>

Cycle	Antibacterial	
Description	Using this cycle helps to reduce bacteria.	
Dry Level	Not adjustable	
Dry Mode	Default: <b>Normal</b>	Available: <b>Normal</b>

Cycle	Delicates	
Description	Use this cycle for drying dress shirts/blouses, nylons, lingerie, or sheer and lacy clothes which can easily be damaged.	
Dry Level	Default: <b>Normal</b>	Available: <b>All</b>
Dry Mode	Default: <b>Normal</b>	Available: <b>Normal</b>

Cycle	Wool	
Description	Use this cycle for drying shrinkable woolen or hand-washable items requiring delicate care.	
Dry Level	Not adjustable	
Dry Mode	Default: <b>Energy Saver</b>	Available: <b>Energy Saver</b>

Cycle	Perm. Press	
Description	Use this cycle to minimize wrinkles when drying tablecloths or wrinkle-free clothes.	
Dry Level	Default: <b>Normal</b>	Available: <b>All</b>
Dry Mode	Default: <b>Normal</b>	Available: <b>Normal</b>

## Manual Dry Cycles

Use Manual Dry cycles to select a specific amount of drying time and a drying temperature. When a Manual Dry cycle is selected, the actual time remaining in your cycle appears on the display. You can change the actual time in the cycle by pressing the **More Time** or **Less Time** buttons.

Cycle	Rack Dry
Description	Use this cycle to dry clothes without tumble action. It is suitable for all fabrics that need refreshing.

Cycle	Heated Dry
Description	Use this cycle to dry clothes that can be tumble dried using heat.

Cycle	Air Dry
Description	Use this cycle to dry all fabrics that can be tumble dried without using heat.

### NOTE

- If the load is less than 1 kg, please use the **Heated Dry**. Wool items should be dried using the **Wool** cycle and heat-sensitive fabrics including silk, underwear and lingerie should be dried using the **Delicates**



cycle. For best results, and to avoid damaging clothes, follow the recommended load size when selecting a cycle.

## Special Drying Cycles

Cycle	Downloaded
<b>Description</b>	<p>This cycle allows you to download a new and specialized drying cycle to your appliance with a smartphone.</p> <ul style="list-style-type: none"> <li>Refer to the <b>LG ThinQ</b> smartphone application to see the cycles available for download.</li> </ul>

## Selectable Drying Options

Cycle		Dry Mode			Wrinkle Care
Cycle	Dry Level	Off	Energy Saver <sup>†</sup>	Normal	
Normal	Very		●	●	●
	Normal		●	●	●
	Damp		●	●	●
Heavy Duty	-		●		●
Bulky/Large	-			●	●
Small Load	-			●	●
Towels	-		●		●
Sportswear	-		●		●
Antibacterial	-			●	●
Delicates	Very			●	●
	Normal			●	●
	Damp			●	●
Wool	-		●		●
Perm. Press	Very			●	●
	Normal			●	●
	Damp			●	●
Rack Dry	-		●		●
Heated Dry	-		●	●	●
Air Dry	-	●			●

<sup>†</sup> This option helps to reduce the energy used when drying clothes by circulating the refrigerant at a lower speed than in the Normal mode. When this option is selected, the drying time will increase.

## Options and Extra Functions

Your dryer includes several additional cycle options to customize cycles to meet your individual needs.

Select the desired option after selecting the desired cycle and settings.

### NOTE

- The LED for the option will light up when the option is selected.
- To protect your garments, not every option is available with every cycle.
- A chime will sound twice and the LED will not light up if the selected option is not allowed for the selected cycle.

## Dry Level

Use this option to select the dryness level for the cycle. Press the **Dry Level** button repeatedly to scroll through available settings.

### NOTE

- This option is only available with the **Normal**, **Delicates**, and **Perm. Press** cycles.
- The appliance will automatically adjust the cycle time according to the selected dryness level. Selecting **Very** will increase the cycle time, while **Damp** will decrease the cycle time.
- Use the **Damp** setting for items that you wish to iron.

## Dry Mode

Use this option to help reduce energy consumption when drying clothes.

- **Normal**: Dry clothes with recommended settings.
- **Energy Saver**: Dry clothes with recommended settings while circulating the refrigerant at a lower speed than **Normal** mode. When the option is selected, the drying time will increase.

## More Time / Less Time

Use these buttons to increase or decrease drying time in 1 minute increments when you use manual drying cycles such as **Rack Dry**, **Heated Dry** and **Air Dry**.

## Wrinkle Care

Selecting this option will tumble the load periodically for up to 2 hours after the selected cycle, or until the door is opened. This is helpful in preventing wrinkles when you are unable to remove items from the dryer immediately.

Press the **Wrinkle Care** button before you start a drying cycle.

### NOTE

- When the option is set, a rectangle with a dashed line and **End** appears on the display until the feature is off.
- When the option is set, only the **Power** button works after the drying cycle ends.
- When a drying cycle is running, pause the cycle first to set the option.
- Always turn off the appliance before unloading the clothes.

## Signal On/Off

The appliance plays a melody when the drying cycle is finished. The buttons make a sound each time they are pressed. Use this button to turn the melody and button tones on or off.

- To turn on/off, press and hold the **Less Time** and **Custom PGM** buttons for 3 seconds at the same time.
- When the signal is muted,  lights up on the display.

## Drum Light

The drum is equipped with a light that illuminates when the appliance is turned on. The light automatically turns off when the dryer door is closed and the cycle starts.

To turn on the light during a cycle, press and hold the **Dry Mode** button for 3 seconds. The drum light will turn on and then turn off automatically after 4 minutes.

## Custom PGM

Save special combinations of settings that are used frequently as a custom program.

## Saving a Custom Program

- 1 Turn on the appliance and select the desired settings using the cycle selector knob and cycle modifier or option buttons.
- 2 Press and hold the **Custom PGM** button for 3 seconds.

### NOTE

- Only one custom program can be saved at a time. Pressing and holding the **Custom PGM** button will overwrite any previously saved custom program.

## Recalling a Custom Program

- 1 Turn on the appliance and press the **Custom PGM** button.
- 2 Press the **Start/Pause** button to start the cycle.

## Rack Dry

Use this function with items, such as wool sweaters, silk items, and lingerie, that should be dried flat. The function can also be used with items that should not be tumbled dry, such as gym shoes or stuffed animals.

### CAUTION

- NEVER tumble dry a load of clothing with the rack installed.

### NOTE

- When the rack is installed, the drum will rotate as usual, but the rack will not move. Make sure all articles to be dried remain completely on the rack and cannot fall off or be pulled off by the turning drum. Be sure to remove the rack after use.
- Some models do not include the drying rack. To purchase a drying rack, contact an LG Electronics Customer Information Center or visit the website at <http://www.lg.com>.

- 1 With the door open, slide the rack into the drum and insert the hook on the drying rack into the hole at the center back of the drum.

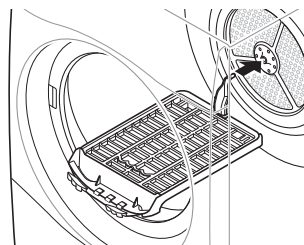

- 2 Seat the front of the rack securely on the inner door rim and the back of the rack on the rim at the back of the drum.

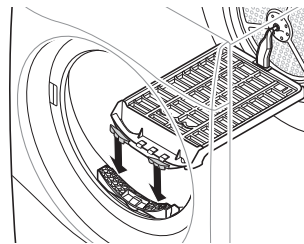

- 3 Place wet items on the rack. Allow space around the items for air to circulate.

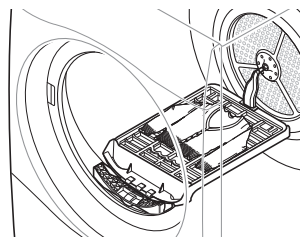

- 4 Close the door and select **Rack Dry**.
- 5 Adjust drying time by pressing the **More Time** and **Less Time** buttons.
- 6 Press the **Start/Pause** button to start the cycle.

## Control Lock

Use this function to disable the controls. This function can prevent children from changing cycles or operating the dryer.

### NOTE

- The function does not lock the door.
- Once this function is set, all buttons are locked except the **Power** button.
- When the controls are locked,  lights up on the display and **CL** appears on the display during the drying cycle.

### NOTE

- Turning off the power will not reset this function. You must deactivate this function before you can access any other options and functions.
- 

### Locking/Unlocking the Control Panel

- 1 Turn on the power.
- 2 Press and hold the **Wrinkle Care** and **Condenser Care** buttons at the same time for 3 seconds to activate or deactivate this function.

# SMART FUNCTIONS

## LG ThinQ Application

The **LG ThinQ** application allows you to communicate with the appliance using a smartphone.

### LG ThinQ Application Features

#### • **Dryer Cycle**

- Download new and specialized cycles that are not included in the standard cycles on the appliance. Appliances that have been successfully connected to the **LG ThinQ** application can download a variety of specialty cycles specific to the appliance. Once cycle download is completed in the appliance, the appliance keeps the downloaded cycle until a new cycle is downloaded.

#### NOTE

- Only one cycle can be stored on the appliance at a time.

#### • **Energy Monitoring**<sup>†</sup>

- This feature keeps track of how the dryer's power consumption is affected by selected drying cycles and options.

#### • **Remote Control**

- Control the appliance remotely or check to see how much time is left in the cycle from the **LG ThinQ** application.

#### NOTE

- Once the remote control feature is enabled, you can start a cycle from the **LG ThinQ** application. If the cycle is not started, the appliance will wait to start the cycle until the appliance is turned off remotely or the remote control feature is disabled.
- If the door is open, the remote control feature is disabled.

#### • **Push Messages**

- When the cycle is complete or the appliance has problems, you will receive a push message.

#### • **Smart Diagnosis**<sup>™</sup>

- This function provides useful information for diagnosing and solving issues with the appliance based on the pattern of use.

#### • **Settings**

- Allows you to set various options on the appliance and in the application.

† This feature is only available on some models.

#### NOTE

- If you change your wireless router, Internet service provider, or password, delete the connected appliance from the **LG ThinQ** application and connect it again.
- This information is current at the time of publication. The application is subject to change for product improvement purposes without notice to users.

### Before Using LG ThinQ Application

- 1 Check the distance between the appliance and the wireless router (Wi-Fi network).
  - If the appliance is too far from the router, the signal becomes weak. It may take a long time to register or installation may fail.
- 2 Turn off the **Mobile data** or **Cellular Data** on your smartphone.

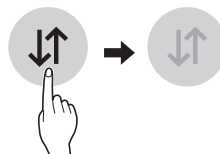

- 3 Connect your smartphone to the wireless router.

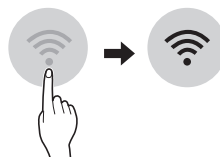

#### NOTE

- To verify the Wi-Fi connection, check that the Wi-Fi icon on the control panel is lit.
- The appliance supports 2.4 GHz Wi-Fi networks only. To check your network frequency, contact your Internet service provider or refer to your wireless router manual.

**NOTE**

- **LG ThinQ** is not responsible for any network connection problems or any faults, malfunctions, or errors caused by network connection.
- The surrounding wireless environment can make the wireless network service run slowly.
- If the appliance is having trouble connecting to the Wi-Fi network, it may be too far from the router. Purchase a Wi-Fi repeater (range extender) to improve the Wi-Fi signal strength.
- The network connection may not work properly depending on the Internet service provider.
- The Wi-Fi may not connect or the connection may be interrupted because of the home network environment.
- If the appliance cannot be registered due to problems with the wireless signal transmission, unplug the appliance and wait about a minute before trying again.
- If the firewall on your wireless router is enabled, disable the firewall or add an exception to it.
- The wireless network name (SSID) should be a combination of English letters and numbers. (Do not use special characters.)
- Smartphone user interface (UI) may vary depending on the mobile operating system (OS) and the manufacturer.
- If the security protocol of the router is set to **WEP**, network setup may fail. Change the security protocol (**WPA2** is recommended), and connect the product again.

**Installing the LG ThinQ Application**

Search for the **LG ThinQ** application from the Google Play Store or Apple App Store on a smartphone. Follow instructions to download and install the application.

**Using the Appliance Remotely****Remote Start**

Use a smartphone to control the appliance remotely. You can also monitor the cycle operation so you know how much time is left in the cycle.

**Using Remote Start**

- 1 Put the laundry into the drum and close the dryer door.

- 2 Press the **Power** button.
- 3 Press and hold the **Remote Start** button for 3 seconds to enable the remote control function.
- 4 Start a cycle from the **LG ThinQ** application on your smartphone.

**NOTE**

- Once the function is enabled, you can only start a cycle from the **LG ThinQ** smartphone application. If the cycle is not started, the application will wait to start the cycle until it is turned off remotely from the application or this function is disabled.
- If the door has been opened, you cannot start a cycle remotely.

**Disabling Remote Start Manually**

When the function is activated, press and hold the **Remote Start** button for 3 seconds.

**Download Cycle**

You can download new and specialized cycles that are not included in the standard cycles on the appliance.

Appliances that have been successfully connected to a Wi-Fi network can download a variety of specialty cycles specific to the appliance.

Once cycle download is completed in the appliance, the product keeps the downloaded cycle until a new cycle is downloaded.

**NOTE**

- Only one downloaded cycle can be stored on the appliance at a time.

**Wireless LAN Module Specifications**

<b>Frequency Range</b>	2412 - 2462 MHz
<b>Output Power (Max)</b>	< 30 dBm

**Industry Canada Statement**

This device contains licence-exempt transmitter(s)/ receiver(s) that comply with Innovation, Science and Economic Development Canada's licence-

exempt RSS(s). Operation is subject to the following two conditions:

- (1) This device may not cause interference.
- (2) This device must accept any interference, including interference that may cause undesired operation of the device.

## IC Radiation Exposure Statement

This equipment complies with IC radiation exposure limits set forth for an uncontrolled environment.

This equipment should be installed and operated with a minimum distance of 20 cm (7.8 inches) between the antenna and your body.

### NOTE



- THE MANUFACTURER IS NOT RESPONSIBLE FOR ANY RADIO OR TV INTERFERENCE CAUSED BY UNAUTHORIZED MODIFICATIONS TO THIS EQUIPMENT. SUCH MODIFICATIONS COULD VOID THE USER'S AUTHORITY TO OPERATE THE EQUIPMENT.

## Open Source Software Notice Information

To obtain the source code under GPL, LGPL, MPL, and other open source licenses, that is contained in this product, please visit <http://opensource.lge.com>. In addition to the source code, all referred license terms, warranty disclaimers and copyright notices are available for download.

LG Electronics will also provide open source code to you on CD-ROM for a charge covering the cost of performing such distribution (such as the cost of media, shipping, and handling) upon email request to [opensource@lge.com](mailto:opensource@lge.com). This offer is valid for a period of three years after our last shipment of this product. This offer is valid to anyone in receipt of this information.

## Smart Diagnosis™ Function

This feature is only available on models with the  or  logo.

Use this feature to help you diagnose and solve problems with your appliance.

### NOTE

- For reasons not attributable to LGE's negligence, the service may not operate due to external factors such as, but not limited to, Wi-Fi unavailability, Wi-Fi disconnection, local app store policy, or app unavailability.
- The feature may be subject to change without prior notice and may have a different form depending on where you are located.

## Using LG ThinQ to Diagnose Issues



If you experience a problem with your Wi-Fi equipped appliance, it can transmit troubleshooting data to a smartphone using the **LG ThinQ** application.

- Launch the **LG ThinQ** application and select the **Smart Diagnosis** feature in the menu. Follow the instructions provided in the **LG ThinQ** application.

## Using Audible Diagnosis to Diagnose Issues

Follow the instructions below to use the audible diagnosis method.

- Launch the **LG ThinQ** application and select the **Smart Diagnosis** feature in the menu. Follow the instructions for audible diagnosis provided in the **LG ThinQ** application.

- 1 Press the **Power** button to turn on the appliance.
  - Do not press any other buttons.
- 2 Hold the mouthpiece of your phone in front of the  or  logo.

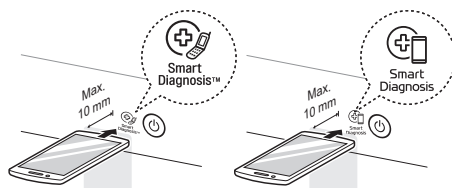

- 3 Press and hold the **More Time** button for 3 seconds or longer while continuing to hold your phone to the logo.
- 4 Keep the phone in place until the tone transmission has finished. The display will count down the time. Once the countdown is

over and the tones have stopped, the diagnosis will be displayed in the application.

---

### **NOTE**

- For best results, do not move the phone while the tones are being transmitted.
-



# MAINTENANCE

## ⚠ WARNING

- Unplug the appliance before cleaning.
- Never use harsh chemicals, abrasive cleaners, or solvents to clean the appliance. They will damage the finish.

## Regular Cleaning

### Cleaning the Lint Filter

#### ⚠ CAUTION

- Refer to the following instructions for proper cleaning of the lint filter. Failure to do so can cause lint buildup on the condenser that can affect the drying performance.

#### NOTE

- Cleaning the lint filter will reduce drying time and energy consumption and prevent unnecessary malfunctions.
- Unload all of the clothes from the appliance before pulling out the lint filter.
- After cleaning the 2-piece lint filter, insert it back into place. The appliance will not operate without the lint filter in place.

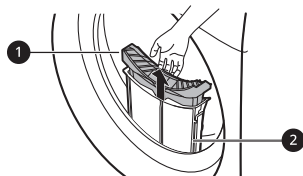

#### ① Inner Filter

- Always clean the inner filter before and after use.

#### ② Outer Filter

- Clean the outer filter after drying 10 times or when the lint has accumulated on the outer filter.
- A chime will sound after every 10 drying cycles and the 🗑️ icon will blink.

### Cleaning the Inner Filter

- 1 Pull out the inner filter from the outer filter and then open the inner filter.
  - Open the filter by unfolding it in the direction of the arrow.

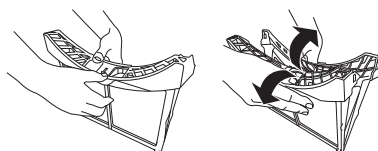

- 2 Use your fingers to get most of the lint off the filter. To clean off residual lint, use a vacuum cleaner or rinse under running water.
  - The filter must be completely dry before using or it could cause an unpleasant odor.

#### ⚠ CAUTION

- Do not tap the filter repeatedly as the built-in magnet may dislodge and cause a malfunction.

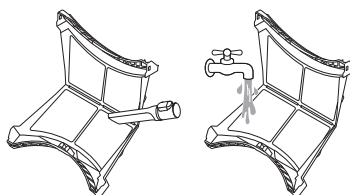

- 3 After drying the inner filter completely, close the filter by pushing the center down.
  - Ensure the left and right sides of the inner filter are closed properly.
- 4 Insert the inner filter into the outer filter.

## Cleaning the Outer Filter

- 1 Remove the dust or lint around the filter inlet.

### ⚠ CAUTION

- If the lint drops into the filter inlet, it may cause degradation of drying performance and increase in drying time.

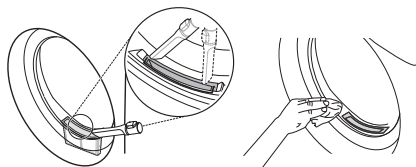

- 2 Pull out the outer filter.

- 3 Remove the inner filter.

- 4 Open the outer filter by grasping the top edge and unfolding the sides.

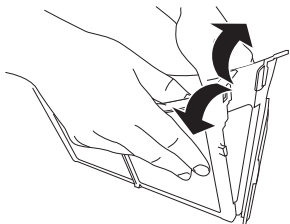

- 5 Remove the residual lint with a vacuum cleaner or by washing under running water.

- If washed, allow the filter to dry completely before use. Failure to do so may cause an odor.

### ⚠ CAUTION

- Do not tap the filter repeatedly as the built in magnet may dislodge and cause a malfunction.

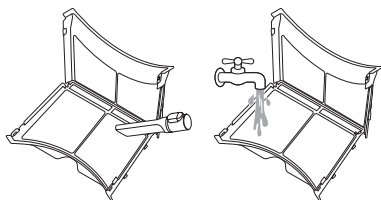

- 6 Push the two sides ① of the filter together to close it.

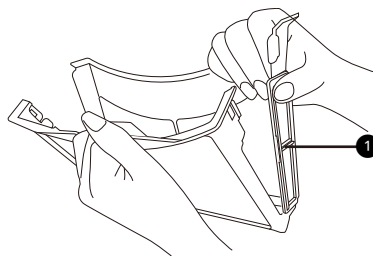

### NOTE

- Ensure the side of the filter is closed properly. If you fail to do so, any lint accumulated on the filter may get into the appliance and may cause degradation of the drying performance.

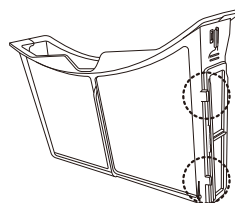

- 7 Reassemble the filters and reinsert them.

### ⚠ CAUTION

- Do not load or remove any clothes when the lint filter is not in place. The clothes can drop into the filter inlet and it may cause the appliance to malfunction.

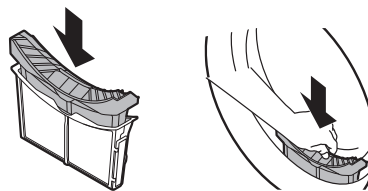

## Emptying the Water Container

Condensed water is collected in the water container. Empty the water container after every use. Not doing so will affect the drying performance.

### NOTE

- If the water container is full,  icon lights up and sounds while the appliance is running.
- If the condensed water is drained out directly through the optional drain hose, there is no need to empty the water container.

- 1 Pull out the water container.

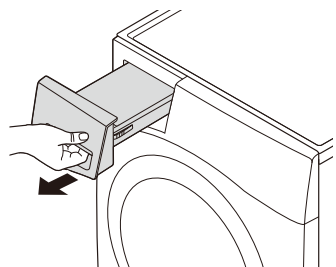

- 2 Empty the water container into the sink.

**CAUTION**

- Do not drink the condensed water or reuse it. Doing so could lead to health problems for people and animals.
- The water container is heavy when full. Hold the water container with two hands and be careful not to drop it.

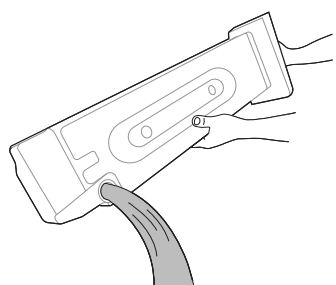

- 3 Refit the water container into the appliance.
  - Push it fully into the appliance until it is in place.
- 4 Press the **Start/Pause** button to run a cycle.

**Cleaning the Exterior**

Proper care of your appliance can extend its life. The outside of the appliance can be cleaned with warm water and a mild, nonabrasive household detergent. Immediately wipe off any spills with a soft, damp cloth.

**NOTE**

- Do not use methylated spirits, solvents, or similar products.
- Never use steel wool or abrasive cleansers; they can damage the surface.

**Cleaning the Interior**

Wipe around the door opening and seal with a soft, damp cloth to prevent lint and dust buildup that could damage the door seal.

Clean the window with a soft cloth dampened with warm water and a mild, nonabrasive household detergent. Then wipe dry.

The stainless steel drum can be cleaned with a conventional stainless steel cleaner, used according to the manufacturer's specifications. Never use steel wool or abrasive cleansers; they may scratch or damage the surface.

**Periodic Cleaning**

**Wiping the Moisture Sensor**

This device senses the moisture level of the clothes during operation. It must be cleaned regularly to remove any buildup of lime scale on the surface of the sensor.

Wipe the sensors inside the drum.

**CAUTION**

- Do not wipe the moisture sensor with abrasive materials. Use a dry acrylic sponge to clean the sensor.

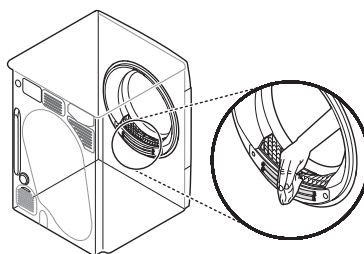

**Cleaning the Cool Air Inlet Grille**

Vacuum the cool air inlet grille 3 - 4 times a year to make sure there is no buildup of lint or dirt that can cause improper airflow. Always unplug the appliance before cleaning or vacuuming it.

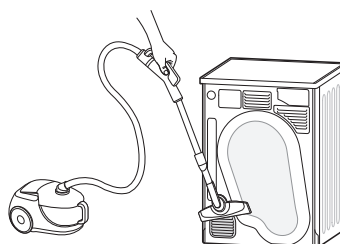

**NOTE**

- Warm air is expelled through the ventilation grille.
- The installation location should have adequate ventilation to avoid pulling in the air from nearby fuel-burning appliances.

**Draining the Remaining Condensed Water**

After drying clothes, a small quantity of condensed water may sit in the base of the appliance and cause odors. Drain the remaining water regularly to reduce any unpleasant odors from the appliance.

**NOTE**

- It's better to drain the remaining water when you are going to be away for a long time, because the remaining water will stagnate and cause odors.
- For best results, drain the remaining water before running **Drum Care**.
- The remaining water can freeze inside the main drain hose(s) and affect the drying performance in cold weather. Draining the remaining water can prevent damage to the appliance from unexpected freezing.

- 1 Run the **Air Dry** cycle for 3 minutes, and then turn off the appliance.
- 2 Unclip the drain tube under the appliance, remove the plug and drain the remaining water.

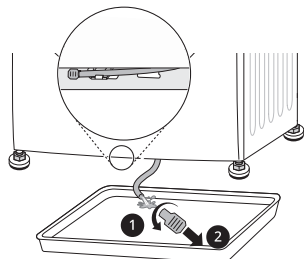
**NOTE**

- Use the water collection tank if the optional drain hose is installed or the appliance is stacked on a washing machine.

- 3 Reassemble the plug onto the drain tube and reclip the drain tube into its holder.

**CAUTION**

- If the plug is not securely inserted into the drain tube, water will leak out and could cause damage.

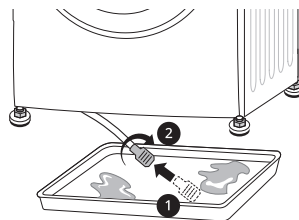
**Using Drum Care Feature**

Run the **Drum Care** cycle periodically to prevent unpleasant odors in the drum.

**CAUTION**

- Remove all of the clothes from the appliance.

- 1 Remove the water container, empty it, and reassemble it.
- 2 Turn on the appliance.
- 3 Press the **Drum Care** button for 3 seconds.

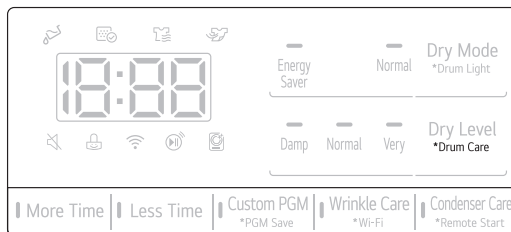

- 4 Press the **Start/Pause** button.
  - This function operates for about 3 hours.
- 5 Empty the water container after the function has finished.

**NOTE**

- If the optional drain hose is installed, there is no need to empty the water container.

- 6 Open the dryer door and leave it open to allow air to circulate in the drum.

**⚠ WARNING**

- For safety reasons, do not allow children or animals to climb into the appliance. Doing so could cause damage or injury.

### Using Condenser Care Feature

The appliance automatically cleans built-up lint off of the condenser using water condensed from the drying process. If needed, the condenser can also be cleaned manually.

**⚠ CAUTION**

- Remove all of the clothes from the appliance.

- 1 Pull out the water container and empty it.
- 2 Pour 34 oz. (1 liter) of clean water slowly into the opening of the water container compartment. Then slide the empty water container back into the compartment.
  - Do not pour the water quickly as it will spill out.
  - Pouring more than 51 oz. (1.5 liters) of water into the compartment will cause water to leak out.

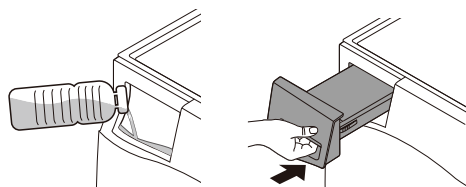

- 3 Turn on the appliance.
- 4 Press the **Condenser Care** button.



- 5 Press the **Start/Pause** button to start cleaning the condenser.
  - The condenser cleaning process takes about 1 hour.
- 6 Empty the water container after the cleaning is finished.

**NOTE**

- If the optional drain hose is installed, there is no need to empty the water container.

- 7 Open the dryer door and leave it open to allow air to circulate and thoroughly dry the drum.

**⚠ WARNING**

- For safety reasons, do not allow children or animals to climb into the appliance. Doing so could cause damage or injury.

### Care in Cold Climates

If the ambient temperature is too low, the condensed water inside the appliance could freeze and affect the appliance operation. If water freezes inside the appliance, follow these steps to thaw out the appliance before using it.

**NOTE**

- **UE** message or icon appears on the display when the condensed water inside the appliance is frozen.

### Thawing out the Accessories

**⚠ CAUTION**

- Wear gloves and take care to avoid burning yourself with hot water.

#### Frozen Water in Drain Hose

- Wrap the drain hose in a towel soaked in hot water (140 °F / 60 °C).

#### Frozen Water in Water Container

- Remove the water container and place it in a sink filled with hot water (140 °F / 60 °C).

## Thawing out the Appliance

### Running the Thawing Mode

- 1 Turn on the appliance and press the **Less Time** button for 3 seconds.

#### NOTE

- Press only the **Less Time** button on the control panel to activate the thawing mode.
- Only the **Power** and **Start/Pause** buttons work when the thawing mode is activated.
- The thawing time cannot be changed manually.
- To deactivate the thawing mode, turn off the appliance.

- 2 Press the **Start/Pause** button to start the thawing mode.
  - Actual thawing time varies depending on the installation environment such as installation location and ambient temperature of the appliance.

- 3 When thawing is complete, dry clothes as usual.



### Thawing out the Appliance Manually

- 1 Open the dryer door and pull out both the inner and outer filters.
- 2 Carefully pour 34 oz. (1 liter) of hot water at 140 °F / 60 °C into the lint filter compartment and then reinsert both lint filters.

#### ⚠ CAUTION

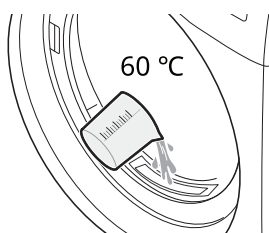
- Pouring more than 51 oz. (1.5 liters) of water into the compartment will cause water to leak out.
- Wear gloves and use care when pouring hot water. 140 °F (60 °C) water can cause scalding or burns. Using water that is hotter than that can cause the appliance to malfunction.



- 3 Turn on the appliance and run the **Normal** cycle for about 30 seconds. Then wait about 30 minutes.
- 4 Run the **Normal** cycle again. Check if the **UE** message appears or  lights up within 10 minutes of running the appliance.
  - If the **UE** message or  icon appears go to step 2 and repeat procedure.
  - If the **UE** message or  do not appear, the thawing process is done.
- 5 When thawing is complete, dry clothes as usual.

# TROUBLESHOOTING

## FAQs

### Frequently Asked Questions

- Q: When I press a button, why does my dryer beep and then nothing happens?**
- A: The Control Lock feature is turned on. To turn off Control Lock, turn the dryer on and press and hold the button that has **Control Lock** on or under it for 3 seconds.
- Q: Why does my dryer take so long to dry clothes?**
- A: Proper airflow is critical to the efficient operation of clothes dryers. A lint filter which is full of lint or clogged with fabric softener sheet residue can reduce the airflow to the point that the time required to dry clothing will be greatly increased.
- Q: Why does my dryer start by itself every few minutes?**
- A: This is how the Wrinkle Care feature works. The dryer runs briefly every few minutes for up to 2 hours after the cycle finishes. This feature is designed to help prevent wrinkles from setting in when the dryer is not unloaded immediately after the cycle is finished.

### User Support Videos

For further assistance, there are videos and tutorials available through the lg.com website.

Scan this QR code to quickly access the video search page on the official LG website.



- 1** On the lg.com/us home page, click on the **Support** menu tab to bring up the menu selections. Select **Video Tutorials**.
- 2** Type **Dryer** in the search box on the new page and click the **Search** button.

## Before Calling for Service

The dryer is equipped with an automatic error-monitoring system to detect and diagnose problems at an early stage. If the dryer does not function properly or does not function at all, check the following before you call for service.

### Error Messages

Problem	Possible Cause & Solution
<b>dE</b> <b>DOOR ERROR</b>	<b>The door has been opened while the appliance is in operation or the appliance is being operated without the door being closed properly.</b> <ul style="list-style-type: none"> <li>• Close the door completely.</li> <li>• If dE recurs, call for service.</li> </ul>
<b>dE4</b> <b>DOOR ERROR</b>	<b>Door switch detection is not working properly.</b> <ul style="list-style-type: none"> <li>• Unplug the power plug and call for service.</li> </ul>
<b>EE1 / EE2</b> <b>TEMPERATURE ERROR</b>	<b>Temperature Sensor has malfunctioned.</b> <ul style="list-style-type: none"> <li>• Unplug the power plug and call for service.</li> </ul>
<b>F1</b> <b>TEMPERATURE ERROR</b>	<b>The temperature inside the drum has risen suddenly.</b> <ul style="list-style-type: none"> <li>• Unplug the power plug and call for service.</li> </ul>
<b>LE1</b> <b>MOTOR LOCKED ERROR</b>	<b>The motor has stopped suddenly.</b> <ul style="list-style-type: none"> <li>• Check if the amount of clothing exceeds the maximum load capacity.</li> <li>• Unplug the power plug and call for service.</li> </ul>
<b>LE2 / RE</b> <b>COMPRESSOR ERROR</b>	<b>The compressor has stopped suddenly.</b> <ul style="list-style-type: none"> <li>• Unplug the power plug and call for service.</li> </ul>
<b>OE</b> <b>DRAIN PUMP ERROR</b>	<b>The drain pump motor has malfunctioned.</b> <ul style="list-style-type: none"> <li>• Unplug the power plug and call for service.</li> </ul>
	<b>The temperature at the installation location is below zero.</b> <ul style="list-style-type: none"> <li>• The recommended surrounding temperature for installation is 41 - 95 °F (5 - 35 °C).</li> </ul>
<b>P5</b> <b>POWER SUPPLY ERROR</b>	<b>Power cord is connected incorrectly.</b> <ul style="list-style-type: none"> <li>• Check the connection of the power cord to the terminal block.</li> </ul>

### Operation

Problem	Possible Cause & Solution
<b>The appliance will not turn on.</b>	<b>Power cord is not properly plugged in.</b> <ul style="list-style-type: none"> <li>• Make sure that the power plug is securely plugged into a grounded outlet matching the appliance's rating plate.</li> </ul>
	<b>House fuse is blown, circuit breaker has tripped, or power outage has occurred.</b> <ul style="list-style-type: none"> <li>• Reset circuit breaker or replace fuse. Do not increase fuse capacity. If the problem is a circuit overload, have it corrected by a qualified electrician.</li> </ul>



Problem	Possible Cause & Solution
<b>The appliance does not heat.</b>	<b>House fuse is blown, circuit breaker has tripped, or power outage has occurred.</b> <ul style="list-style-type: none"> <li>Reset circuit breaker or replace fuse. Do not increase fuse capacity. If the problem is a circuit overload, have it corrected by a qualified electrician.</li> </ul>
	<b>Selected cycle does not use heat.</b> <ul style="list-style-type: none"> <li>Some cycles default to unheated or air drying. Select a cycle that allows heated drying.</li> </ul>
<b>Water leaks.</b>	<b>The water container hose or the optional drain hose is not connected correctly.</b> <ul style="list-style-type: none"> <li>Connect the water container hose or the optional drain hose correctly.</li> </ul>
	<b>The door is closed while clothes or foreign substance is caught in the door.</b> <ul style="list-style-type: none"> <li>Check if clothes or foreign substance is caught in the door before using the appliance. If water leaks continuously, contact the LG Electronics Customer Information Center.</li> </ul>
<b>The appliance runs and pauses by itself after the drying cycle finishes.</b>	<b>This is normal operation for the Wrinkle Care option.</b> <ul style="list-style-type: none"> <li>Check to see if the <b>Wrinkle Care</b> option has been selected. The option is designed to prevent creases that are formed when the clothes are not unloaded promptly after the drying cycle. When the option is set, the appliance runs for 10 seconds and pauses for 5 minutes. The option runs for up to 2 hours.</li> </ul>
<b>The control panel time has stopped at 1 minute.</b>	<b>The cool down stage is operating to cool down high internal temperature of the drum for customer safety.</b> <ul style="list-style-type: none"> <li>The cool down stage can run for up to 20 minutes depending on the internal temperature of the drum.</li> </ul>
<b>Drying ended earlier than the initial control panel time.</b>	<b>The clothes are dried according to the Dry level or Dry mode setting.</b> <ul style="list-style-type: none"> <li>If the humidity or temperature in the drum reaches the product setting, the dry cycle may end earlier than the control panel time.</li> </ul>
<b>Clothes take too long to dry.</b>	<b>Energy Saver option selected (on some models).</b> <ul style="list-style-type: none"> <li>If using the <b>Normal</b> mode, deselect the <b>Energy Saver</b> mode. The <b>Energy Saver</b> mode reduces energy use but takes longer to dry clothes than the <b>Normal</b> mode.</li> </ul>

## Performance

Problem	Possible Cause & Solution
<b>Clothes are wrinkled.</b>	<b>Clothes dried too long (overdried).</b> <ul style="list-style-type: none"> <li>Over drying a load of laundry can lead to wrinkled clothes. Try a shorter drying time or use the lower dry level setting and remove items while they still retain a slight amount of moisture.</li> </ul>
	<b>Clothes left in dryer too long after cycle ends.</b> <ul style="list-style-type: none"> <li>Use the <b>Wrinkle Care</b> option. This option will tumble the clothes briefly every few minutes for up to 2 hours to help prevent wrinkling.</li> </ul>
<b>Greasy or dirty spots on clothes.</b>	<b>Fabric softener used incorrectly.</b> <ul style="list-style-type: none"> <li>Confirm and follow the instructions provided with your fabric softener.</li> </ul>
	<b>Clean and dirty clothes are being dried together.</b> <ul style="list-style-type: none"> <li>Use your dryer to dry only clean items. Soil from dirty clothes can transfer to the clean clothes in the same or later loads.</li> </ul>
	<b>Clothes were not properly cleaned or rinsed before being placed in the dryer.</b> <ul style="list-style-type: none"> <li>Stains on dried clothes could be stains that were not removed during the washing process. Make sure that clothes are being completely cleaned or rinsed according to the instructions for your washer and detergent. Some difficult soils may require pre-treating prior to washing.</li> </ul>

Problem	Possible Cause & Solution
<b>Clothes are shrinking.</b>	<p><b>Garment care instructions are not being followed.</b></p> <ul style="list-style-type: none"> <li>To avoid shrinking your clothes, always consult and follow fabric care instructions. Some fabrics will naturally shrink when washed. Other fabrics can be washed but will shrink when dried in a dryer. Use a low or no heat setting.</li> </ul>
<b>Lint on clothes.</b>	<p><b>Lint filter not cleaned properly.</b></p> <ul style="list-style-type: none"> <li>Remove the lint from the filter before every load. With the lint removed, hold the filter up to a light to see if it is dirty or clogged. If it looks dirty, follow the cleaning instructions in the <b>MAINTENANCE</b> section. With some loads that produce high amounts of lint, it may be necessary to clean the filter during the cycle.</li> </ul>
	<p><b>Laundry not sorted properly.</b></p> <ul style="list-style-type: none"> <li>Some fabrics are lint producers (i.e., a fuzzy white cotton towel) and should be dried separately from clothes that are lint trappers (i.e., a pair of black linen pants).</li> </ul>
	<p><b>Excess static in clothes.</b></p> <ul style="list-style-type: none"> <li>Use a fabric softener to reduce static electricity. Be sure to follow the manufacturer's instructions. Overdrying a load of laundry can cause a buildup of static electricity.</li> <li>Adjust settings and use a shorter drying time, or use <b>Sensor Dry</b> cycles.</li> </ul>
	<p><b>The appliance is overloaded.</b></p> <ul style="list-style-type: none"> <li>Divide extra large loads into smaller loads for drying.</li> </ul>
	<p><b>Tissue, paper, etc., left in pockets.</b></p> <ul style="list-style-type: none"> <li>Check pockets thoroughly before washing and drying clothes.</li> </ul>
<b>Excess static in clothes after drying.</b>	<p><b>Fabric softener is not used or used incorrectly.</b></p> <ul style="list-style-type: none"> <li>Use a fabric softener or the <b>Reduce Static</b> option, if equipped, to reduce static electricity. Be sure to follow the manufacturer's instructions.</li> </ul>
	<p><b>Clothes dried too long (overdried).</b></p> <ul style="list-style-type: none"> <li>Overdrying a load of laundry can cause a buildup of static electricity. Adjust settings and use a shorter drying time, or use <b>Manual Dry</b> cycles. Select a lower dry level setting on <b>Sensor Dry</b> cycles, if necessary.</li> </ul>
	<p><b>Drying synthetics, permanent press, or synthetic blends.</b></p> <ul style="list-style-type: none"> <li>These fabrics are naturally more prone to static buildup. Try using fabric softener, or use a lower dry level setting and/or shorter time settings for <b>Manual Dry</b> cycles.</li> </ul>
<b>Clothes have damp spots after a Sensor Dry cycle.</b>	<p><b>Very large load or very small load. Single large item such as a blanket or comforter.</b></p> <ul style="list-style-type: none"> <li>If items are too tightly packed or too sparse the sensor may have trouble reading the dryness level of the load. Use a <b>Timed Dry</b> cycle for very small loads.</li> <li>Large, bulky items such as blankets or comforters can sometimes wrap themselves into a tight ball of fabric. The outside layers will dry and register on the sensors, while the inner core remains damp. When drying a single bulky item, it may help to pause the cycle once or twice and rearrange the item to unwrap and expose any damp areas.</li> <li>To dry a few remaining damp items from a very large load or a few damp spots on a large item after a sensor cycle has completed, empty the lint trap, and then set a <b>Timed Dry</b> cycle to finish drying the item(s).</li> </ul>

## Odors

Problem	Possible Cause & Solution
<b>The appliance has an unpleasant odor.</b>	<b>Are you using the appliance for the first time?</b> <ul style="list-style-type: none"> <li>The odor is caused by the rubber material inside the appliance. The odor normal when the appliance is new and disappears after you run several cycles.</li> </ul>
	<b>Do you smell an odor during use?</b> <ul style="list-style-type: none"> <li>Do not exceed the manufacturer's recommended amount of detergent when washing clothes. Excess detergent can build up on clothing and cause odors.</li> <li>Leaving clothes in the washer or dryer after the cycle ends can lead to odors. Unload clothing promptly when the cycle ends.</li> <li>If the odor is coming from the washer, follow the instructions in the product manual to clean the washer tub/drum.</li> <li>Keep both lint filters clean. Clogged or dirty lint filters can cause odors. After cleaning the lint filter, allow it to dry completely before using it.</li> <li>Periodically run the Drum Care and Condenser Care cycles following the instructions in the <b>MAINTENANCE</b> section.</li> </ul>

## Wi-Fi

Problem	Possible Cause & Solution
<b>Trouble connecting appliance and smartphone to Wi-Fi network.</b>	<b>The password for the Wi-Fi network was entered incorrectly.</b> <ul style="list-style-type: none"> <li>Delete your home Wi-Fi network and begin the connection process again.</li> </ul>
	<b>Mobile data for your smartphone is turned on.</b> <ul style="list-style-type: none"> <li>Turn off the <b>Mobile data</b> on your smartphone before connecting the appliance.</li> </ul>
	<b>The wireless network name (SSID) is set incorrectly.</b> <ul style="list-style-type: none"> <li>The wireless network name (SSID) should be a combination of English letters and numbers. (Do not use special characters.)</li> </ul>
	<b>The router frequency is not 2.4 GHz.</b> <ul style="list-style-type: none"> <li>Only a 2.4 GHz router frequency is supported. Set the wireless router to 2.4 GHz and connect the appliance to the wireless router. To check the router frequency, check with your Internet service provider or the router manufacturer.</li> </ul>
	<b>The appliance is too far from the router.</b> <ul style="list-style-type: none"> <li>If the appliance is too far from the router, the signal may be weak and the connection may not be configured correctly. Move the router closer to the appliance or purchase and install a Wi-Fi repeater.</li> </ul>

# WARRANTY

## CANADA

### TERMS AND CONDITIONS

**ARBITRATION NOTICE: THIS LIMITED WARRANTY CONTAINS AN ARBITRATION PROVISION THAT REQUIRES YOU AND LG TO RESOLVE DISPUTES BY BINDING ARBITRATION INSTEAD OF IN COURT, UNLESS THE LAWS OF YOUR PROVINCE OR TERRITORY DO NOT PERMIT THAT, OR, IN OTHER JURISDICTIONS, IF YOU CHOOSE TO OPT OUT. IN ARBITRATION, CLASS ACTIONS AND JURY TRIALS ARE NOT PERMITTED. PLEASE SEE THE SECTION TITLED "PROCEDURE FOR RESOLVING DISPUTES" BELOW.**

Should your LG Dryer ("Product") fail due to a defect in materials or workmanship under normal and proper use, during the warranty period set forth below, LG Electronics Canada, Inc. ("LGECI") will, at its option, repair, replace or pro rate the Product upon receipt of proof of the original retail purchase. This limited warranty is valid only to the original retail purchaser of the Product and applies only to a Product distributed, purchased from an authorized retailer and used within Canada, as determined at the sole discretion of LGECI.

<b>WARRANTY PERIOD (Note: If the original date of purchase cannot be verified, the warranty will begin sixty (60) days from the date of manufacture)</b>		
<b>Period</b>	<b>Scope of Warranty</b>	<b>HOW SERVICE IS HANDLED</b>
One (1) year from the date of original retail purchase	Parts and Labor (internal/functional parts only)	LG will provide parts and labor to repair or replace defective parts.
Three (3) years from the date of original retail purchase	Dryer Drum	Parts only. Customer will be responsible for any labor or in-home service to replace defective parts.
Ten (10) years from date of original retail purchase	Dual Inverter Compressor Inverter Motor	Parts only. Customer will be responsible for any labor or in-home service to replace defective parts.

- Replacement products and parts are warranted for the remaining portion of the original warranty period or ninety (90) days, whichever is greater.
- Replacement products and parts may be new, reconditioned, refurbished, or otherwise factory remanufactured, all at the sole discretion of LGECI.
- Proof of original retail purchase specifying the Product model and date of purchase is required to obtain warranty service under this Limited Warranty.

**LGECI'S SOLE LIABILITY IS LIMITED TO THE LIMITED WARRANTY SET OUT ABOVE. EXCEPT AS EXPRESSLY PROVIDED ABOVE, LGECI MAKES NO, AND HEREBY DISCLAIMS, ALL OTHER WARRANTIES AND CONDITIONS RESPECTING THE PRODUCT, WHETHER EXPRESS OR IMPLIED, INCLUDING BUT NOT LIMITED TO, ANY IMPLIED WARRANTY OR CONDITION OF MERCHANTABILITY OR FITNESS FOR A PARTICULAR PURPOSE, AND NO REPRESENTATIONS SHALL BE BINDING ON LGECI. LGECI DOES NOT AUTHORIZE ANY PERSON TO CREATE OR ASSUME FOR IT ANY OTHER WARRANTY OBLIGATION OR LIABILITY IN CONNECTION WITH THE PRODUCT. TO THE EXTENT THAT ANY WARRANTY OR CONDITION IS IMPLIED BY LAW, IT IS LIMITED TO THE WARRANTY PERIOD SET OUT ABOVE. UNDER NO CIRCUMSTANCES SHALL LGECI, THE MANUFACTURER OR DISTRIBUTOR OF THE PRODUCT, BE LIABLE FOR ANY INCIDENTAL, CONSEQUENTIAL, SPECIAL, DIRECT, INDIRECT, PUNITIVE OR EXEMPLARY DAMAGES, INCLUDING, WITHOUT LIMITATION, LOSS OF GOODWILL, LOST PROFITS, LOSS OF ANTICIPATED PROFITS, LOST REVENUE, LOSS OF USE, OR ANY OTHER DAMAGE, WHETHER ARISING DIRECTLY OR INDIRECTLY FROM ANY CONTRACTUAL BREACH, FUNDAMENTAL BREACH, TORT OR OTHERWISE, OR FROM ANY ACTS OR OMISSIONS. LGECI'S TOTAL LIABILITY, IF ANY, SHALL NOT EXCEED THE PURCHASE PRICE PAID BY YOU FOR THE PRODUCT.**

This Limited Warranty gives you specific legal rights. You may also have other rights that vary from province to province depending on applicable provincial laws. Any term of this Limited Warranty that negates or varies any implied condition or warranty under provincial law is severable where it conflicts with such provincial law without affecting the remainder of this warranty's terms.

### THIS LIMITED WARRANTY DOES NOT COVER:

- Service trips to i) deliver, pick up, or install or; educate on how to operate the Product; ii) correct wiring or plumbing; or iii) correct unauthorized repairs or installations of the Product;
- Damage or failure of the Product to perform during power failures and interrupted or inadequate electrical service;
- Damage or failure caused by leaky or broken water pipes, frozen water pipes, restricted drain lines, inadequate or interrupted water supply or inadequate supply of air;
- Damage or failure resulting from operating the Product in a corrosive atmosphere or contrary to the instructions outlined in the Product's owner's manual;
- Damage or failure to the Product caused by accidents, pests and vermin, lightning, wind, fire, floods, acts of God, or any other causes beyond the control of LGECI or the manufacturer;
- Damage or failure resulting from misuse, abuse, improper installation, repair, or maintenance of the Product. Improper repair includes use of parts not authorized or specified by LGECI. Improper installation or maintenance includes installation or maintenance contrary to the Product's owner's manual;
- Damage or failure caused by unauthorized modification or alteration of the Product, or if used for other than the intended household purpose/use of the Product, or damage or failure resulting from any water leakage due to improper installation of the Product;
- Damage or failure caused by incorrect electrical current, voltage or plumbing codes;
- Damage or failure caused by use that is other than normal household use, including, without limitation, commercial or industrial use, including use in commercial offices or recreational facilities, or as otherwise outlined in the Product's owner's manual;
- Damage or failure caused by the use of any accessories, components or cleaning products, including, without limitation, that are not approved/authorized by LGECI;
- Damage or failure caused by transportation and handling, including scratches, dents, chips and/or other damage to the finish of the Product, unless such damage results from defects in materials or workmanship and is reported to LGECI within one (1) week of delivery of the Products;
- Damage or missing items to any display, open box, refurbished or discounted Product;
- Refurbished Product or any Product sold "As Is", "Where Is", "With all Faults", or any similar disclaimer;
- Products with original serial numbers that have been removed, altered or cannot be readily determined at the discretion of LGECI;
- Increases in utility costs and additional utility expenses in any way associated with the Product;
- Replacement of light bulbs, filters, fuses or any other consumable parts;
- Costs associated with removal and/or reinstallation of the Product for repairs;
- Noises associated with normal operation and failure to follow instructions found in the use and care and installation guides or operating the unit in an unsuitable environment will not be covered under this warranty.
- Coverage for "in Home" repairs, for products in-warranty, will be provided if the Product is within a 150 km radius from the nearest authorized service center (ASC), as determined by LG Canada. If your Product is located outside a 150 km radius from a ASC, as determined by LG Canada, it will be your responsibility to bring the Product, at your sole expense, to the ASC for in-warranty repair.
- Conversion of product from natural gas or LP gas.

**All costs and expenses associated with the above excluded circumstances, listed under the heading, This Limited Warranty Does Not Cover, shall be borne by the consumer.**

TO OBTAIN WARRANTY SERVICE AND ADDITIONAL INFORMATION, PLEASE CALL OR VISIT OUR WEBSITE:

Call 1-888-542-2623 and select the appropriate option from the menu, or visit our website at <http://www.lg.com>

## **PROCEDURE FOR RESOLVING DISPUTES:**

EXCEPT WHERE PROHIBITED AT LAW, ALL DISPUTES BETWEEN YOU AND LG ARISING OUT OF OR RELATING IN ANY WAY TO THIS LIMITED WARRANTY OR THE PRODUCT SHALL BE RESOLVED EXCLUSIVELY THROUGH BINDING ARBITRATION, AND NOT IN A COURT OF GENERAL JURISDICTION. EXCEPT WHERE PROHIBITED AT LAW, YOU AND LG BOTH IRREVOCABLY AGREE TO WAIVE THE RIGHT TO A JURY TRIAL AND TO BRING OR PARTICIPATE IN A CLASS ACTION.

**Definitions.** For the purposes of this section, references to “LG” mean LG Electronics Canada, Inc., its parents, subsidiaries and affiliates, and each of their officers, directors, employees, agents, beneficiaries, predecessors in interest, successors, assigns and suppliers; references to “dispute” or “claim” shall include any dispute, claim or controversy of any kind whatsoever (whether based in contract, tort, statute, regulation, ordinance, fraud, misrepresentation or any other legal or equitable theory) arising out of or relating in any way to the sale, condition or performance of the product or this Limited Warranty.

**Notice of Dispute.** In the event you intend to commence an arbitration proceeding, you must first notify LG in writing at least 30 days in advance of initiating the arbitration by sending a letter to LGECI Legal Team at 20 Norelco Drive, North York, Ontario, Canada M9L 2X6 (the “Notice of Dispute”). You and LG agree to engage in good faith discussions in an attempt to amicably resolve your claim. The notice must provide your name, address, and telephone number; identify the product that is the subject of the claim; and describe the nature of the claim and the relief being sought. If you and LG are unable to resolve the dispute within 30 days of LG’s receipt of the Notice of Dispute, the dispute shall be resolved by binding arbitration in accordance with the procedure set out herein. You and LG both agree that, during the arbitration proceeding, the terms (including any amount) of any settlement offer made by either you or LG will not be disclosed to the arbitrator until the arbitrator determines the dispute.

**Agreement to Binding Arbitration and Class Action Waiver.** Upon failure to resolve the dispute during the 30 day period after LG’s receipt of the Notice of Dispute, you and LG agree to resolve any claims between you and LG only by binding arbitration on an individual basis, unless you opt out as provided below, or you reside in a jurisdiction that prevents full application of this clause in the circumstances of the claims at issue (in which case if you are a consumer, this clause will only apply if you expressly agree to the arbitration). To the extent permitted by applicable law, any dispute between you and LG shall not be combined or consolidated with a dispute involving any other person’s or entity’s product or claim. More specifically, without limitation of the foregoing, except to the extent such a prohibition is not permitted at law, any dispute between you and LG shall not under any circumstances proceed as part of a class or representative action. Instead of arbitration, either party may bring an individual action in small claims court, but that small claims court action may not be brought on a class or representative basis except to the extent this prohibition is not permitted at law in your province or territory of jurisdiction as it relates to the claims at issue between you and LG.

**Arbitration Rules and Procedures.** To begin arbitration of a claim, either you or LG must make a written demand for arbitration. The arbitration will be private and confidential, and conducted on a simplified and expedited basis before a single arbitrator chosen by the parties under the provincial or territorial commercial arbitration law and rules of the province or territory of your residence. You must also send a copy of your written demand to LG at LG Electronics, Canada, Inc., Attn: Legal Department- Arbitration, 20 Norelco Drive, North York, Ontario M9L 2X6. This arbitration provision is governed by your applicable provincial or territorial commercial arbitration legislation. Judgment may be entered on the arbitrator’s award in any court of competent jurisdiction. All issues are for the arbitrator to decide, except that, issues relating to the scope and enforceability of the arbitration provision and to the arbitrability of the dispute are for the court to decide. The arbitrator is bound by the terms of this provision.

**Governing Law.** The law of the province or territory of your purchase shall govern this Limited Warranty and any disputes between you and LG except to the extent that such law is preempted by or inconsistent with applicable federal or provincial/territorial law. Should arbitration not be permitted for any claim, action, dispute or controversy between you and LG, you and LG attorn to the exclusive jurisdiction of the courts of the province or territory of your purchase for the resolution of the claim, action, dispute or controversy between you and LG.

**Fees/Costs.** You do not need to pay any fee to begin an arbitration. Upon receipt of your written demand for arbitration, LG will promptly pay all arbitration filing fees unless you seek more than \$25,000 in damages, in which case the payment of these fees will be governed by the applicable arbitration rules. Except as otherwise provided for herein, LG will pay all filing, administration and arbitrator fees for any arbitration initiated in accordance with the applicable arbitration rules and this arbitration provision. If you prevail in the arbitration, LG will pay your attorneys' fees and expenses as long as they are reasonable, by considering factors including, but not limited to, the purchase amount and claim amount. Notwithstanding the foregoing, if applicable law allows for an award of reasonable attorneys' fees and expenses, an arbitrator can award them to the same extent that a court would. If the arbitrator finds either the substance of your claim or the relief sought in the demand is frivolous or brought for an improper purpose (as measured by the applicable laws), then the payment of all arbitration fees will be governed by the applicable arbitration rules. In such a situation, you agree to reimburse LG for all monies previously disbursed by it that are otherwise your obligation to pay under the applicable arbitration rules. Except as otherwise provided for, LG waives any rights it may have to seek attorneys' fees and expenses from you if LG prevails in the arbitration.

**Hearings and Location.** If your claim is for \$25,000 or less, you may choose to have the arbitration conducted solely (1) on the basis of documents submitted to the arbitrator, (2) through a telephonic hearing, or (3) by an in-person hearing as established by the applicable arbitration rules. If your claim exceeds \$25,000, the right to a hearing will be determined by the applicable arbitration rules. Any in-person arbitration hearings will be held at the nearest, most mutually-convenient arbitration location available within the province or territory in which you reside unless you and LG both agree to another location or agree to a telephonic arbitration.

**Severability and Waiver.** If any portion of this Limited Warranty (including these arbitration procedures) is unenforceable, the remaining provisions will continue in full force and effect to the maximum extent permitted by applicable law. Should LG fail to enforce strict performance of any provision of this Limited Warranty (including these arbitration procedures), it does not mean that LG intends to waive or has waived any provision or part of this Limited Warranty.

**Opt Out.** You may opt out of this dispute resolution procedure. If you opt out, neither you nor LG can require the other to participate in an arbitration proceeding. To opt out, you must send notice to LG no later than 30 calendar days from the date of the first consumer purchaser's purchase of the product by either (i) sending an e-mail to [optout@lge.com](mailto:optout@lge.com), with the subject line: "Arbitration Opt Out;" or (ii) calling 1-800-980-2973. You must include in the opt out e-mail or provide by telephone: (a) your name and address; (b) the date on which the product was purchased; (c) the product model name or model number; and (d) the serial number (the serial number can be found (i) on the product; or (ii) online by accessing [https://www.lg.com/ca\\_en/support/repair-service/schedule-repair](https://www.lg.com/ca_en/support/repair-service/schedule-repair) and clicking on "Find My Model & Serial Number").

In the event that you "Opt Out", the law of the province or territory of your residence shall govern this Limited Warranty and any disputes between you and LG except to the extent that such law is preempted by or inconsistent with applicable federal or provincial/territorial law. Should arbitration not be permitted for any claim, action, dispute or controversy between you and LG, you and LG agree to attorn to the exclusive jurisdiction of the courts of the province or territory of your residence for the resolution of the claim, action, dispute or controversy between you and LG.

You may only opt out of the dispute resolution procedure in the manner described above (that is, by e-mail or telephone); no other form of notice will be effective to opt out of this dispute resolution procedure. Opting out of this dispute resolution procedure will not affect the coverage of the Limited Warranty in any way, and you will continue to enjoy the full benefits of the Limited Warranty. If you keep this product and do not opt out, then you accept all terms and conditions of the arbitration provision described above.

**Conflict of Terms.** In the event of a conflict or inconsistency between the terms of this Limited Warranty and the End User License Agreement ("EULA") in regards to dispute resolution, the terms of this Limited Warranty shall control and govern the rights and obligations of the parties and shall take precedence over the EULA.













**LG**

Life's Good

LG Customer Information Center

For inquiries or comments,  
visit **www.lg.com** or call:

**1-800-243-0000** U.S.A.

**1-888-542-2623** CANADA

Register your product Online!

**www.lg.com**