

BlackJack-RedJack Column and Plate Kits

UPDATED PRODUCT LINE - NEW COLUMN AND PLATE KITS

Same strong columns with Column Kits and four new Plate Kits to fit different beams and load requirements.

Going forward RedJack 2.5, BlackJack 3.0 and RedJack 3.0 structural columns will be sold as two kits: a Column Kit and a Plate Kit.

The Column Kit will be made up of the column steel tube along with the collar and screw assembly, and the Plate Kit will include top and bottom plates.

The Column Kits are identified by a streamlined naming convention that reflects column series and lengths. It is now easier than ever to select the right column and plates for your project.

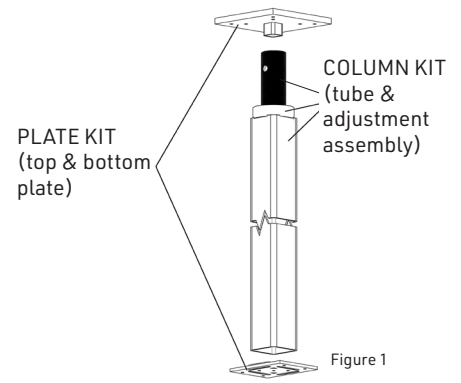

Figure 1

	New column name	Adjustable Height		Old column name
		in	mm	
Black Jack 2.5 (single unit)	BJ25x90	86-90	2184-2286	NEW COLUMN LENGTH
	BJ25x110	106-110	2692-2794	T2JP110
RedJack 2.5 (column kit)	RJ25x96	92-96	2337-2438	T2JPLD96
	RJ25x102	98-102	2489-2591	T2JPLD102
	RJ25x108	104-108	2642-2743	T2JPLD108
	RJ25x120	116-120	2946-3048	T2JPLD120
BlackJack 3.0 (column kit)	BJ30x96	92-96	2337-2438	T2JPM96
	BJ30x102	98-102	2489-2591	T2JPM102
	BJ30x108	104-108	2642-2743	T2JPM108
	BJ30x120	116-120	2946-3048	T2JPM120
RedJack 3.0 (column kit)	RJ30x90	86-90	2184-2286	T2JPHD90
	RJ30x96	92-96	2337-2438	T2JPHD96
	RJ30x102	98-102	2489-2591	T2JPHD102
	RJ30x108	104-108	2642-2743	T2JPHD108
	RJ30x114	110-114	2794-2896	T2JPHD114
	RJ30x120	116-120	2946-3048	T2JPHD120
	RJ30x144	140-144	3556-3658	T2JPHD144

Single Unit

NEW COLUMN KITS



BlackJack 2.5	RedJack 2.5	BlackJack 3.0	RedJack 3.0
BlackJack 2.5 columns do not change and are still sold as a unit, composed of the column tube, screw assembly and plates.	<ul style="list-style-type: none"> BlackJack 3.0, RedJack 2.5 & 3.0 columns are now sold in two kits: column kit and plate kit. 15 Columns Kits consist of a steel tube, collar and screw assembly. Streamlined naming of Column Kits better reflect the length and strength of the columns. ex. the RedJack 3.0 96" column used to be identified as T2JPHD96 will now be named RJ30x96 4 new Plate Kits that only include top and bottom plates, replace the former Universal Component Kit. Column and Plate kits are to be sold and used together; the two distinct kits provide better flexibility to suit various project applications and load requirements. 		

Our new Plate Kits (PKA, PKB, PKC and PKD) allow for a more precise fit to your project's beams and load requirements. Each plate kit (PK) comes with one PL plate and one A or B or C or D plate.

Plate	Dimensions (in)	W	L	Gauge / Thickness	Beam Size	Installation Notes
PL (4.5 x 6) Bottom Plate		4.5	6	3 GA	3-Ply 2x 4-Ply 2x	Interchangeable with A (3.5 x 5.25) plate and can be used as top plate only on RJ25 columns
Plate A ** (3.5 x 5.25)		3.5	5.25	3 GA	2-Ply SCL 3-Ply SCL 2-Ply 2x 3-Ply 2x	Interchangeable with PL (4.5 x 6) plate and can be used as bottom plate only on RJ25 columns
Top Plate B * (3.5 x 7)		3.5	7	1/2"	2-Ply SCL 4-Ply SCL	Use 4 outer holes for beam attachment
					2-Ply 2x 4-Ply 2x	
					3-Ply SCL 3-Ply 2x	Use 4 inner holes for beam attachment
Top Plate C * (5.25 x 7)		5.25	7	1/2"	3-Ply SCL 4-Ply SCL	Use all 4 holes for beam attachment
					3-Ply 2x 4-Ply 2x	
Top Plate D * (7 x 7)		7	7	1/2"	4-Ply SCL 4-Ply 2x	Use 4 outer holes for beam attachment
					3-Ply SCL 3-Ply 2x	

SCL members assume 1-3/4" width.

Bold: Beam size the plate is optimally sized for.

Grey shade: Rotate plate to fit, beam width parallel with the longer side of the plate.



* Plates are shown upside down for illustration purposes. Refer to figure 1 for plate position when installed.

** Plate A is shown in the bottom plate position.



Selecting your BlackJack or RedJack Column Kit

Use your height and capacity requirement to determine the correct MiTek Column Kit for your project.

	RedJack 2.5	BlackJack 3.0	RedJack 3.0
Column kit			
	2.5" x 2.5" tube, 11 gauge	3.0" x 3.0" tube, 10 gauge	3.0" x 3.0" tube, 8 gauge
Extended lengths available * (maximum 4" adjustment)	96", 102", 108" and 120"	96", 102", 108" and 120"	90", 96", 102", 108", 114", 120" and 144"

MiTek Red Jack 2.5, Black Jack 3.0, & Red Jack 3.0 Column Kits are sold separately from MiTek Plate Kits.

MiTek Red Jack 2.5, Black Jack 3.0, & Red Jack 3.0 Column Kits are to be exclusively used with MiTek Plate Kits PKA, PKB, PKC and PKD.

When choosing your plate kit and column kit for your application, both the column capacity and the plate capacity must be considered. The lower value governs. For Steel Beams, use Plate Kit A and column capacity as the top plate capacity is not relevant.

* For additional flexibility, column tubes can be cut to adapt to your project's height requirement. Ensure cut is smooth and square.

Selecting your Plate Kit

Use your beam material and beam width to determine the correct MiTek Plate Kit for your project.

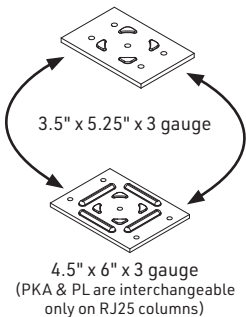
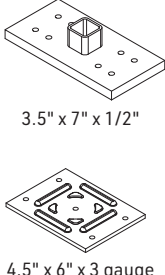
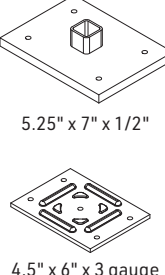
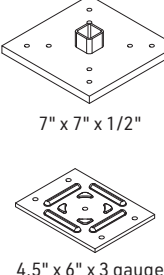
	PKA: Plate A** + PL	PKB: Top Plate B* + PL	PKC: Top Plate C* + PL	PKD: Top Plate D* + PL
Plate kit	 <p>3.5" x 5.25" x 3 gauge</p> <p>4.5" x 6" x 3 gauge (PKA & PL are interchangeable only on RJ25 columns)</p>	 <p>3.5" x 7" x 1/2"</p> <p>4.5" x 6" x 3 gauge</p>	 <p>5.25" x 7" x 1/2"</p> <p>4.5" x 6" x 3 gauge</p>	 <p>7" x 7" x 1/2"</p> <p>4.5" x 6" x 3 gauge</p>
Intended Use - Plates A, B, C or D	Steel beam 2 or 3-ply lumber beam 2 or 3-ply SCL beam or as a bottom plate of RJ 2.5	2, 3 or 4-ply lumber beam 2, 3 or 4-ply SCL beam	3 or 4-ply lumber beam 3 or 4-ply SCL beam	3 or 4-ply lumber beam 3 or 4-ply SCL beam
Intended Use - PL	3 or 4-ply lumber beam or as a bottom plate of RJ 2.5	Bottom plate	Bottom plate	Bottom plate

MiTek Plate Kits are sold separately from MiTek Structural Column Kits.

MiTek Plate Kits are to be exclusively used with MiTek Red Jack 2.5, Black Jack 3.0, & Red Jack 3.0 columns.

When choosing your plate kit and column kit for your application, both the column capacity and the plate capacity must be considered. The lower value governs. For Steel Beams, use Plate Kit A and column capacity as the top plate capacity is not relevant.

*Plates are shown upside down for illustration purposes. Refer to figure 1 for plate position when installed.

** Plate A is shown in the bottom plate position.

Select your Column and Plate Kit using the load charts by scanning the QR code

