

How to Install the QuickHang™ Installation Kit

FOR RESIDENTIAL USE:

- The QuickHang™ hardware in this kit is designed to work with solid wood and engineered wood joists in residential ceiling applications.

KIT INCLUDES:

- (3) 6' Main beams
- (9) 4' Cross tees
- (9) 2' Cross tees (only included in 2' x 2' installation kits)
- (6) 6' Wall moldings
- (6) QuickHang hooks
- (6) Joist brackets
- (40) Nails (15 for joist brackets; 25 for wall molding)

SAFETY TIPS

- Safety glasses and gloves are recommended to be worn during installation. Metal grid components can be sharp.
- The hardware in this kit is designed to support ceiling and grid components only.
- When working overhead, make sure your work area is clear of obstructions and that your ladder is stable.
- Do not cut QuickHang hooks. If the hook needs to be shortened due to an obstruction, the top portion can be bent by hand or with pliers.

IMPORTANT INFORMATION:

- Store and install panels in areas with a temperature range of 60° to 80°F and not more than 70% relative humidity.
- Remove panels from the cartons 24 hours before installation and allow them to adjust to normal interior conditions of the area where installation will take place.
- Never install ceiling panels below an existing ceiling that contains embedded radiant-heat coils.
- Do not apply loose fill or batt insulation so that it rests directly on the panels.
- Keep hands clean to avoid smudges on the finished ceiling.
- Always cut ceiling panels face up with a sharp utility knife.
- Main beams should be installed perpendicular to the joists.
- Main beams are typically installed on 4' centers. If your room configuration is unusual, you may require additional components.
- The minimum drop is 2.5" to allow for ceiling tile installation and accessibility.
- Installations with light fixtures will likely require additional clearance. Consult the light manufacturer's instructions for details.
- When using QuickHang™ installation kits to install Metallaire™ (or other non-standard) panels, please refer to separate installation instructions in panel package, or online at ceilings.com, for important considerations pertaining to those panels.

TOOLS NEEDED TO INSTALL YOUR CEILING

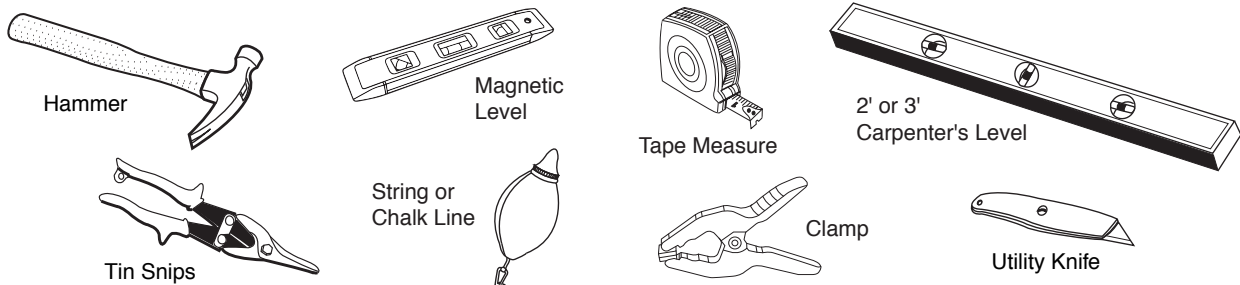

How to Install the QuickHang™ Installation Kit

SAMPLE PANEL LAYOUT

Determine panel layout

For best appearance, border panels should be the same size on the opposite sides of the room and as large as possible. Use your room dimensions and follow the formula in the worksheets below.

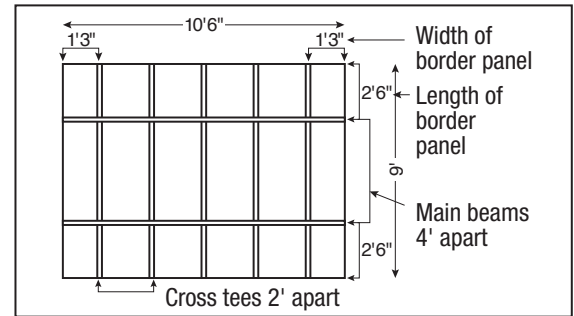

Sample worksheets using 2' x 4' panels in a 9' x 10' 6" room

Determine length of border panels	
9'	Room length
÷ 4'*	Panel length
(2) 4' panels + 1 foot remainder	Tiles across room
1'	Remainder
+ 4'*	Panel length
5'	Tile borders (both sides)
÷ 2	Number of panels
2' 6"	Border panel length

Determine width of border panels	
10' 6"	Room width
÷ 2'	Panel width
(5) 2' panels + 6 inches remainder	Tiles across room
6"	Remainder
+ 2'	Panel width
2' 6"	Tile borders (both sides)
÷ 2	Number of panels
1' 3"	Border panel width

*Use 4-ft for 2-ft x 4-ft panel, 2-ft for 2-ft x 2-ft panel

STEP 1

INSTALL WALL MOLDING

NOTE: Kit hardware allows for ceiling drops from 2.5" to 12" below the bottom of the joists.

- Mark the desired height of your new ceiling on the wall **(A)**.
- Add 3/4" (the height of the Wall Molding) above the desired ceiling height and mark a level line around 3 walls **(B)**.
- Use a string line to mark the 4th wall.
- Nail Wall Molding to the wall studs **(C)**.
- If nailing molding directly to wall is not possible (for example, a solid concrete or stone wall), hang a section of main beam next to the wall as a substitute for regular wall molding **(D)**.

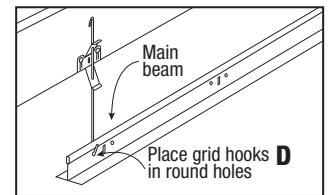
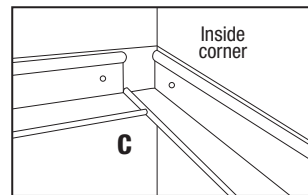
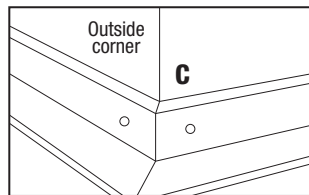
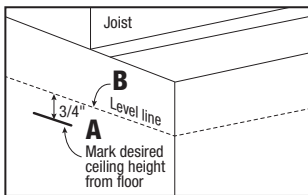

STEP 2

INSTALL QUICKHANG HARDWARE

TIPS: Measure and mark your joists prior to installation. Use a string line or chalk line to align marks perpendicular to joists across the room.

IMPORTANT: The first row of main beams in a 2' x 4' panel installation should be the border panel size from the wall. In a 2' x 2' panel installation, the first main beam can be the border panel size or the border panel + 24" from the wall. Example: See Sample Room Hanger Layout – 2' 6" from the wall for a 2' x 4' panel. Brackets should not be spaced more than 4' apart in any direction.

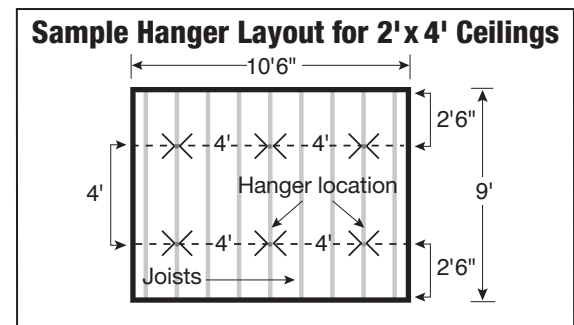

How to Install the QuickHang™ Installation Kit

- Hang your string line or snap your chalk line to position your main beams 4' apart.
- Make a 1" long vertical mark up the side of each joist where a bracket will be located **(A)**.
- Use the center hole in the brackets to line the brackets up with your marks **(B)**.
- Hammer in the 2 tabs for a temporary hold **(C)**.
- Nail the bracket to the joist through the two openings above the hammer tabs with the nails included in the kit **(D)**.
– **OPTIONAL:** You can also secure the bracket to the joist with a single #5 Wood Screw through the center hole (screws not included in kit hardware.)
- With the bracket securely attached to the joist, insert the grid hook using the diamond-shaped holes in the brackets. Thread the small end of the hook, from the back, through the lower hole **(E)**. Push the hook up and rotate to thread through the upper hole, squeezing the spring tabs to allow the wire to go through **(F)**.

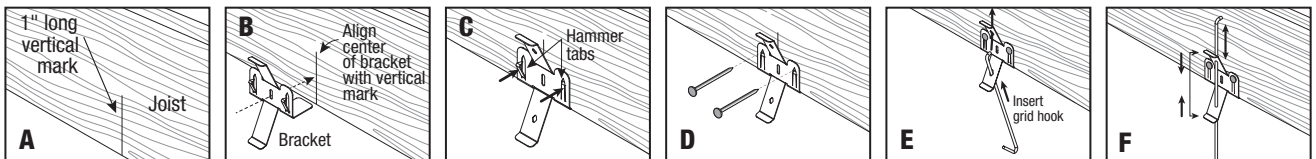

IMPORTANT: Do not cut QuickHang hooks. If the hook needs to be shortened due to an obstruction, the top portion can be bent by hand or with pliers.

- Turn all hooks in the same direction, parallel to the joists.
- Set the hooks at about the same height; the bottom of the hooks should align with the top of the wall molding.
- To adjust the height of the hook, squeeze the upper and lower spring tabs while lifting or lowering the hook.

NOTE: You will do final leveling once all of the grid is installed.

STEP 3

INSTALL AND LEVEL GRID

Prepare to Hang the First Main Beam

- To prepare the first main beam, trim the end of the main beam so that a cross tee slot on the main beam is the border panel distance from the wall **(B)**. (This creates the proper border tile opening.)

TIP: Cut the top of the grid first with tin snips and then bend the grid open and cut the face of the grid **(A)**.

Hang the Main Beam

- Place the cut end of the first main beam on the wall molding and using the round holes in the grid, hang main beams on the hooks perpendicular to joists. Do this same step with the next main beam running parallel 4' away along the wall.

Prepare and Cut First Border Cross Tees

- Stretch a string line from one end of the room to the other below the wall molding and along the edge furthest from the wall of the main beams **(A)**. (illus. A)
- Install your first cross tee in the main beam cross tee slot that is your border panel distance from the wall.
- Hold the end of your border cross tee against the wall **(B)**. (illus. A) Mark and cut the cross tee where it crosses the string line.

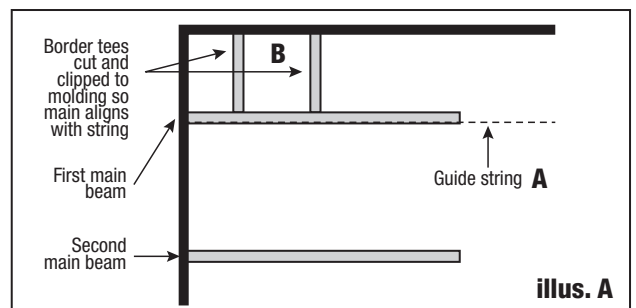
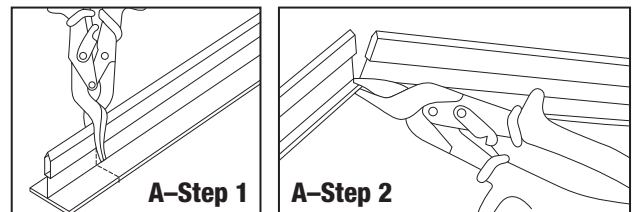
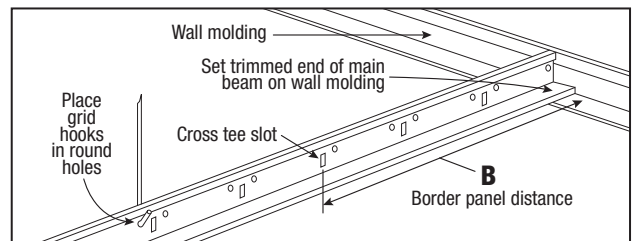

How to Install the QuickHang™ Installation Kit

- Insert the uncut end of the cross tee into the main beam through the rectangular hole and rest the cut end of the tee on the wall molding.
- Cut the second border cross tee to length and insert it.
- Temporarily fasten the cross tees to the wall molding with a clamp or tape so they do not move.

Squaring the Grid

To achieve the best end results, it is important to make sure your grid is square at this point in the installation. This will allow you to adjust if changes are required.

- Install two 4' cross tees between the two main beams in line with the first two border tees **(C)**. **(illus. B)**

NOTE: When connecting two cross tees in the same rectangular hole of a main beam, insert the second tee into the slot by passing on the **right side** of the already installed cross tee.

TIP: Installing cross tees is easier if the tee is inserted into the rectangular slot at a downward angle from above the grid plane. Listen for an audible click to ensure a good connection.

- To check that your grid is square, measure across the diagonals of the 2' x 4' opening. The measurements will be the same if the grid is square. If the measurements are not the same, trim one of the mains further until the diagonals are equal. **(illus. B)**

Installing Remaining Grid & Leveling the System

- Complete the first two rows of main beams by hanging main beams from the hooks and joining their ends together. Listen for an audible click to ensure a good connection. **(illus. C)**

At the far end of each of these first two rows, you'll need to cut both main beams to rest on the wall molding.

TIP: Use the left-over ends of the cut mains to start additional rows of main beams.

- Cut additional border cross tees between the wall and first row of main beams.
- If you have additional rows of main beams to install, stretch a second string from one side of the room to the other aligning it with the first 4' cross tee as shown **(D)** **(illus. B)**.
- This second string will be your guide for cutting the remaining rows of main beams. Just measure from the end wall to the string to determine the distance for the first rectangular cross tee slot you will use.

NOTE: You must line up cross tee slots for the grid to be square!

- Install all remaining main beams and 4' cross tees.
- Measure and cut border cross tees along the last wall.
- Now that your grid is installed, it's time to do final leveling.
- Start by attaching a magnetic level to the bottom of a main beam located in a corner of the room. (Main beam should be along a wall, resting on wall molding.) Holding the main beam, squeeze the spring tabs on the QuickHang bracket to allow the hook to slide up or down. Adjust the main beam to be level and resting on your wall molding. Working from the corner of your room, check and level cross tees and main beams until the system is level.

TIP: For additional guidance, see our video online at ceilings.com/installation.

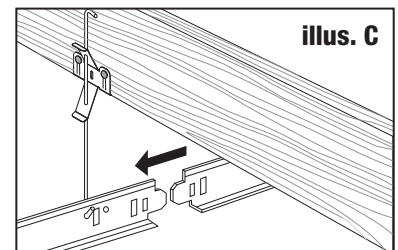
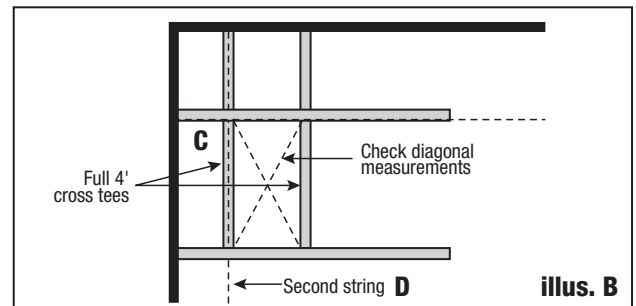
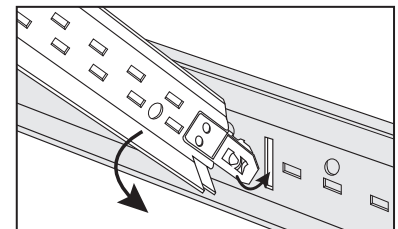
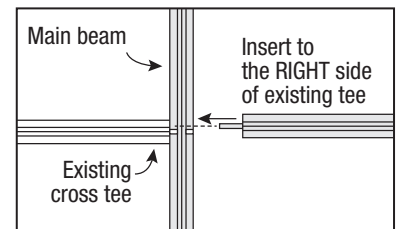
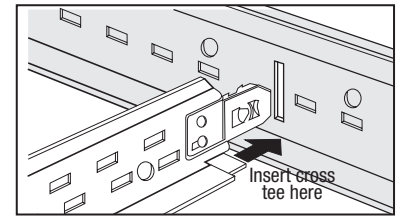

How to Install the QuickHang™ Installation Kit

STEP 4

INSTALL CEILING PANELS

- Lift panel at angle up through the grid; drop into place **(A)**.
- TIP:** If there's an obstruction in the area where you are inserting a ceiling tile, you may need to lift the ceiling tile through an adjacent opening and gently move it across the back of the grid into place.
- Trim border panels using a straight edge; panels should be cut face side up. **(B)**. For tegular tiles, you will need to cut the edge that's resting on the wall molding to allow it to lay flat.

For additional information on installing suspended ceilings, please visit our website at ceilings.com or call Techline at 1-877-ARMSTRONG (276-7876).

Limited Warranty

For warranty information, please visit ceilings.com/warranty.

