

PACKAGE CONTENTS – CONTENU DE L'EMBALLAGE – CONTENIDO DEL PAQUETE

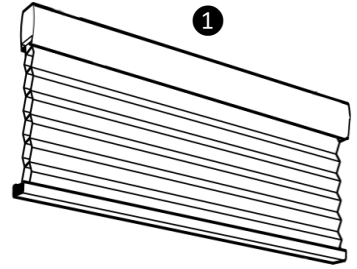
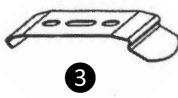
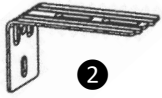

- ① Honeycomb Shade (1)
- ② Wall brackets (2)
- ③ Mounting brackets (2)
- ④ Screws (4)
- ⑤ Wall plugs (4)
- ⑥ Bolt (2) / Nut (2)

- ① Store Alvéolaire (1)
- ② Supports muraux (2)
- ③ Supports de fixation (2)
- ④ Vis (4)
- ⑤ Chevilles (2)
- ⑥ Écrous (2) / Boulons (2)

- ① Persiana Panal (1)
- ② Soportes de pared (2)
- ③ Soportes de montaje (2)
- ④ Tornillos (4)
- ⑤ Taquete (4)
- ⑥ Tuercas (2) / Pernos (2)

TOOLS REQUIRED – OUTILS NECESSAIRE – HERRAMIENTAS NECESARIAS

Not Included – Non Inclus – No Incluidas

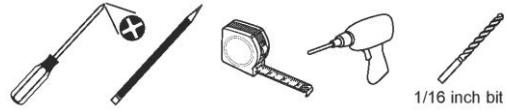

HOW TO USE WALL PLUGS – COMMENT UTILISER LES CHEVILLES – COMO USAR LOS TAQUETES

Tools not Included – Outils non inclus – Herramientas no incluidas

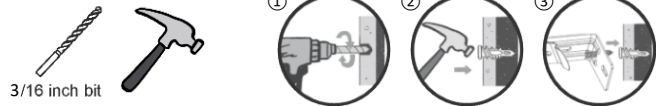

HOW TO OPERATE A CORDLESS SHADE – MODE D'EMPLOI D'UN STORE SANS CORDONS – CÓMO OPERAR SU PERSIANA SIN CORDÓN

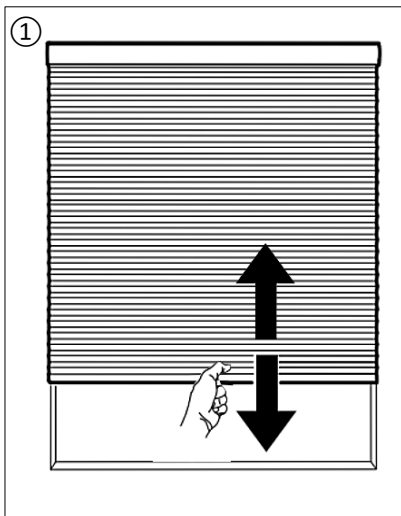

- ① To raise and lower your cordless blind: Hold the bottom rail in the middle (you may use both hands on wider blinds). To raise, simply lift the bottom rail. To lower, gently pull the bottom rail to the height desired (as shown in the graphic).
- ① Pour lever et baisser votre store sans cordon: Tenez la barre inférieure au milieu (vous pouvez utiliser vos deux mains sur des stores plus larges). Pour soulever, il suffit de soulever le rail inférieur. Pour abaisser, tirez doucement le rail inférieur à la hauteur souhaitée (comme indiqué dans le graphique).
- ① Para elevar y bajar la persiana sin cordón: Con una mano sostenga la base de la persiana (use las dos manos para persianas mas grandes). Para subir, simplemente levante la base. Para bajar, tire suavemente la base de la persiana a la altura deseada (como se muestra en la gráfica).

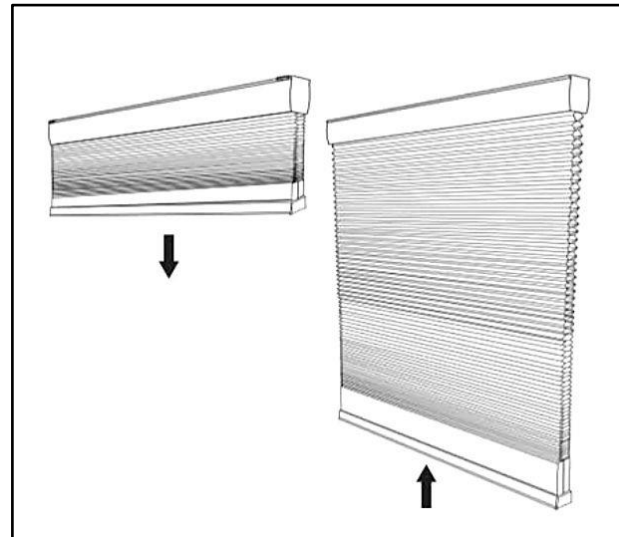

- ② Care instructions: Clean using a damp cloth or vacuum using proper attachments or duster.
- ② Conseils d'entretien: Nettoyer avec un chiffon humide, un aspirateur en utilisant les accessoires appropriés ou un plumeau.
- ② Instrucciones de cuidado: Limpie con un paño húmedo, con una aspiradora usando los accesorios o con un plumero.

- 1.** Choose inside mount or outside mount
Choisissez une fixation intérieure ou extérieure
Elija una fijación interior o exterior

- 2.** Mounting brackets position
Position des supports de fixation
Posición de las abrazaderas de montaje

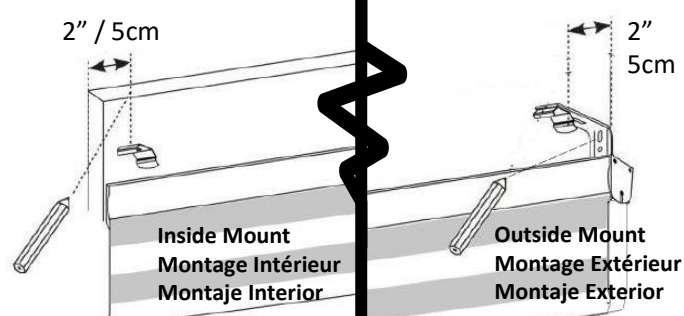
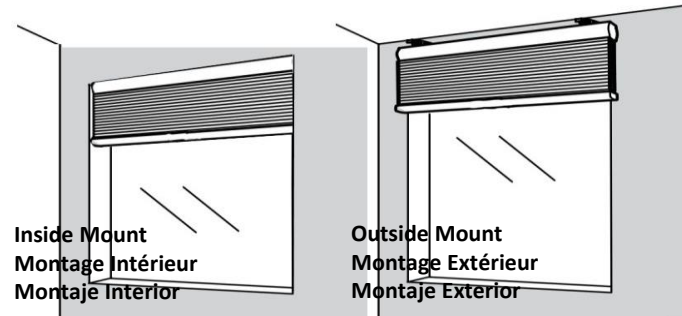

- 3.** Pre-drill holes for easy installation
Faire un pré-perçage pour une installation facile
Pre-perforar agujeros para una instalación fácil

- 4.** Mount the brackets
Installez les supports de fixation
Instale los soportes de montaje

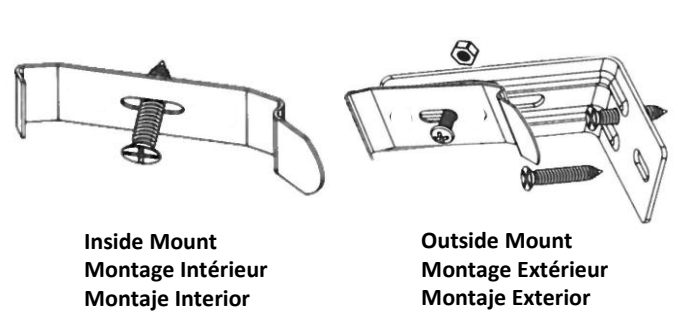
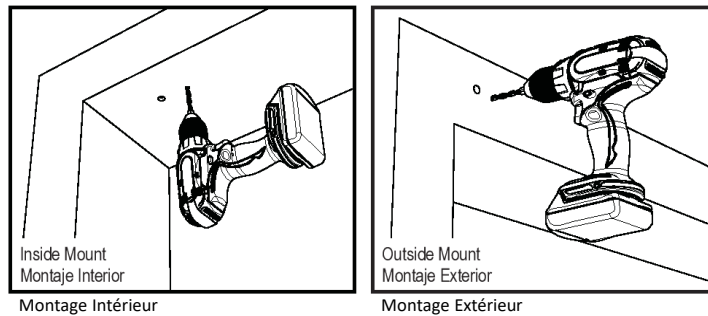

- 5.** Mounting the blind
Installation du store
Montaje de la persiana

- 6.** How to operate a cordless shade
Mode d'emploi d'un store sans cordons
Cómo operar su persiana sin cordón

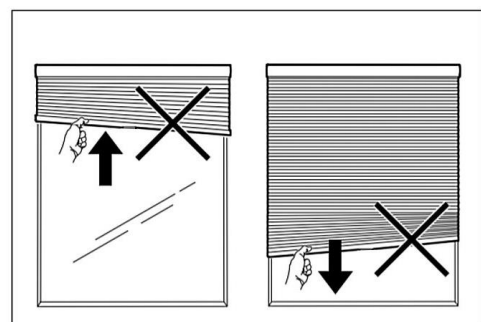
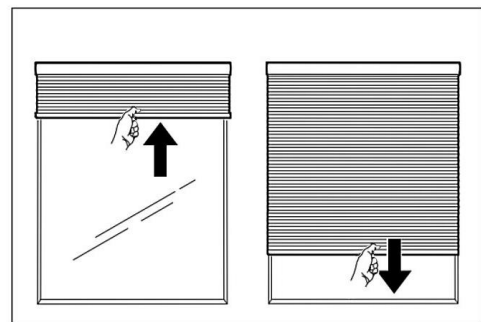
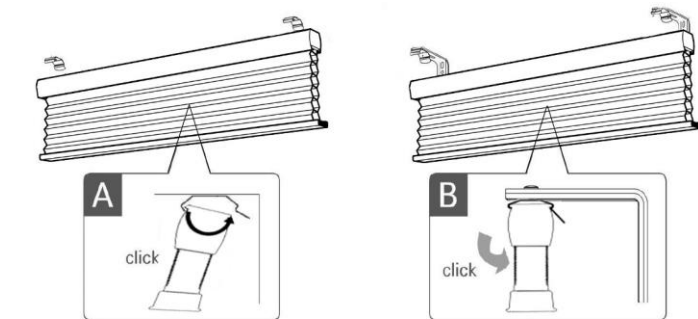

- Position the inner front edge of the head rail into the front of the mounting bracket. Push the back of the rail to snap into the bracket metal clip until you hear a click.
- Positionnez le bord avant intérieur du rail supérieur dans l'avant du support de fixation. Poussez l'arrière du rail pour s'enclencher dans le clip en métal du support jusqu'à ce que vous entendiez un déclic.
- Posicione el extremo posterior de la persiana en el frente de la abrazadera de montaje. Presione la parte trasera de la persiana hasta que ingrese en la abrazadera y escuche un clic.