

# BENCHMARK<sup>TM</sup><sub>MC</sub>

## 30L STAINLESS STEEL WET DRY VACUUM



LIMITED  
**5** YEAR\*  
WARRANTY

120V 60Hz  
5 year limited warranty



Intertek  
5002219  
JN308

Wet/Dry vacuums used without a filter made of HEPA-rated material to extract drywall dust, will void the warranty.

**READ ALL INSTRUCTIONS BEFORE FIRST USE.  
KEEP THIS MANUAL FOR FUTURE REFERENCE.  
KEEP AWAY FROM CHILDREN.**



**WEAR CSA APPROVED  
EYE PROTECTION**



**WEAR EAR  
PROTECTION**



**WEAR A  
FACE MASK**

## PRODUCT SPECIFICATIONS

| 30L STAINLESS STEEL WET DRY VACUUM      |                            |
|---|----------------------------|
| Voltage                                 | 120V~ 60Hz                 |
| Rated Power                             | 8.5A 6.5Peak HP            |
| Tank Capacity                           | 7.9Gal (30L)               |
| Flexi Hose                              | 1 1/4" x 5ft (32mm x 1.5m) |
| Flow rate                               | 60CFM                      |
| Power cord                              | 13.13ft. (4m)              |
| Replacement cartridge filter            | 1277-035                   |
| Replacement collection bag              | 1277-032                   |
| Replacement foam filter sleeve          | 1277-047                   |
| HEPA cartridge filter (sold separately) | 1277-037                   |
| Weight                                  | 16.8LBS. (7.6KG)           |

When using an extension cord with your Wet Dry Vac refer to the following table to determine the required AWG wire size. Before using the vacuum cleaner make sure the power cord and extension cord are in good working condition. Make repairs or replacements before using the vacuum cleaner. Only use extension cords that are rated for outdoor use.

| LENGTH OF EXTENSION CORD |               |               |                 |               |
|--------------------------|---------------|---------------|-----------------|---------------|
| 110V-120V                | 25' (7.5 m)   | 50' (15.25 m) | 100' (30.5 m)   | 150' (45.7 m) |
| Amps                     | AWG Wire Size |               |                 |               |
| 0-6                      | 18            | 16            | 16              | 14            |
| 7-10                     | 18            | 16            | 14              | 12            |
| 11-12                    | 16            | 16            | 14              | 12            |
| 13-16                    | 14            | 12            | Not Recommended |               |

### NEED ASSISTANCE?

Call us on our toll-free customer support line:  
1-866-349-8665 (Monday through Friday 9am – 5pm Eastern Standard Time)

- Technical questions
- Replacement parts
- Parts missing from package

**TABLE OF CONTENTS**

Product Specifications ..... 1  
Table of Contents ..... 2  
General Safety Warnings ..... 3  
Safety Symbols ..... 3  
Specific Safety Instructions for 30L Stainless Steel Wet Dry Vacuum ..... 3-5  
Servicing of a Double-Insulated Wet Dry Vacuum ..... 5-6  
Know your Wet Dry Vacuum ..... 7  
Operation ..... 8-11  
Maintenance ..... 12-13  
Exploded View ..... 14  
Parts List ..... 15-16  
Warranty ..... 17





## GENERAL SAFETY WARNINGS

### IMPORTANT SAFETY INSTRUCTIONS

Read and understand all safety and operational instructions. Failure to follow the safety rules listed below and other basic safety precautions may result in serious personal injury. Keep this manual, sales receipts and applicable warranty forms for future reference.

### SAFETY SYMBOLS

The purpose of safety symbols is to alert you of the potential safety RISKS. Recognize and understand them. Follow the instructions provided.

| SYMBOL   | MEANING   |
|--|---|
|   | Failure to obey a <b>DANGER</b> safety alert <b>WILL</b> result in serious personal injury or death to you or to others. Always obey all messages following this symbol to reduce the risk of serious personal injury or death.           |
|   | Failure to obey a <b>WARNING</b> safety alert <b>MAY</b> result in serious personal injury or death to you or to others. Always obey all messages following this symbol to reduce the risk of potential serious personal injury or death. |
|   | Failure to obey a <b>CAUTION</b> safety alert <b>MAY</b> result in personal injury or property damage to you or to others. Always obey all messages following this symbol to reduce the risk of personal injury or property damage.       |
|  | Failure to obey a <b>NOTICE</b> or a <b>CAUTION</b> (without a safety alert) <b>MAY</b> result in property damage to you or to others. Always obey all messages following this symbol to reduce the risk of property damage.              |

## SPECIFIC SAFETY INSTRUCTIONS FOR 30L STAINLESS STEEL WET DRY VACUUM

### SAVE THIS MANUAL FOR FUTURE REFERENCE

- Read all instructions before using this appliance.
- Read and understand this instruction manual and all labels on the Wet Dry Vacuum before using.
- Safety is a combination of common sense, staying alert and knowing how this Wet Dry Vacuum works. Use this Wet Dry Vacuum only as described in this manual. To reduce the risk of personal injury or damage to the Wet Dry Vacuum, use only recommended accessories.

**WHEN USING THIS WET DRY VACUUM FOLLOW BASIC SAFETY PRECAUTIONS INCLUDING THE FOLLOWING:****To reduce the risk of fire, electric shock or injury:**

- Do not run the Wet Dry Vacuum unattended.
- Do not vacuum, or use this Wet Dry Vacuum near liquids, gases, or explosive vapours like gasoline or similar fuels, lighter fluid, cleaners, oil based paints, natural gas or hydrogen.
- Do not vacuum or use this Wet Dry Vacuum near explosive dusts like coal dust, magnesium dust, grain dust, or gunpowder as sparks inside the motor can ignite flammable vapours or dust.
- Do not vacuum burning or smoking items such as cigarettes, matches, or hot ashes.
- Keep the cord away from heated surfaces.
- Do not expose to rain. Store indoors.
- Do not unplug by pulling on cord. To unplug, grasp the plug, not the cord.
- Do not use if the cord, plug or other parts are damaged.
- If the Wet Dry Vacuum is not working correctly or has missing parts, has been dropped or damaged, left outdoors or dropped in water, return it to an independent service centre.
- Do not pull or carry by the cord. Do not use the cord as a handle, close a door on the cord, or pull the cord around sharp edges or corners.
- Do not run the Wet Dry Vacuum over the cord.
- Do not handle the plug or the Wet Dry Vacuum with wet hands.
- To reduce the risk of health hazards from vapours or dusts, do not vacuum toxic materials.
- Do not use or store near hazardous materials.
- Do not use this Wet Dry Vacuum with a torn filter or without installing the filter except when vacuuming liquids as described in the operation section of this manual.
- Do not use the Wet Dry Vacuum as a toy. Pay particularly close attention when it is being used by or near children.
- To reduce the risk of injury from the Wet Dry Vacuum accidentally starting, unplug the power cord before changing or cleaning the filter.
- Do not leave the Wet Dry Vacuum unattended when it is plugged in. Unplug it from the power outlet when not in use and before servicing. Turn off the Wet Dry Vacuum before unplugging.
- Do not put any objects into the ventilation openings. Do not vacuum with the ventilation openings blocked.
- Keep free of dust, lint, hair or any other items that may reduce the air flow.
- Keep hair, loose clothing, fingers, and all body parts away from openings and moving parts.
- To reduce the risk of falling, use extra care when cleaning on stairs.

## WHEN USING AS BLOWER:

- Direct air discharge only at work area.
- Do not use Wet Dry Vac as a sprayer.
- Do not direct air at bystanders.
- Keep children away when blowing.
- Wear safety goggles.

This Wet Dry Vacuum is double-insulated, eliminating the need for a separate grounding system. Use only identical replacements parts. Read the servicing instructions before servicing the Wet Dry Vacuum.

Use this Wet Dry Vacuum only as described in this manual.

Observe the following warnings that appear on the motor housing of this Wet Dry Vacuum.

### **WARNING**

## SERVICING OF A DOUBLE-INSULATED WET DRY VACUUM

In a double-insulated Wet Dry Vacuum, two systems of insulation are provided instead of grounding. This means that no grounding is provided on a double-insulated appliance, nor should a means for grounding be added. Servicing a double-insulated Wet Dry Vacuum requires extreme care and knowledge of the system and should be done only by qualified service personnel. Replacement parts for a double-insulated Wet Dry Vacuum must be identical to the parts they replace. The double-insulated Wet Dry Vacuum is marked with the words "DOUBLE INSULATED" and the symbol  may also be marked on the appliance.

- For household use only.
- To reduce the risk of electric shock, unplug before cleaning or servicing.
- DO NOT use without filters in place.
- To reduce the risk of electric shock, use indoors only.

### **WARNING**

If the supply cord is damaged, it must be replaced by the manufacturer or its service agent or a similarly qualified person in order to avoid a hazard.

### **WARNING**

Remove the plug from the socket before performing maintenance. Before using the machine make sure that the frequency and voltage shown on the rating plate correspond with the mains voltage. Specifications and details are subject to change without prior notice. The accessories shown in the pictures may vary from model to model.

### **WARNING**

For your own safety, read and understand this instruction manual. Do not operate unattended. Do not use this Wet Dry Vacuum to pick up hot ashes, coals, toxic, flammable or other hazardous materials. Do not use near explosive liquids or vapours.

### **WARNING**

To reduce the risk of electric shock, do not expose to rain. Store indoors.

** CAUTION**

Do not vacuum drywall dust or cold fireplace soot or ash with a standard Wet Dry filter. This dust is very fine and hence will not be captured by the filter and may cause damage. Refer to the operation section for proper filter selection.

** CAUTION**

To reduce the risk of injury from moving parts, unplug before servicing.

**SAVE THIS USER MANUAL**

** WARNING**

MISUSE or failure to follow the safety rules stated in this instruction manual may cause serious personal injury.

## KNOW YOUR WET DRY VACUUM

### ATTENTION

Before starting please read, understand, and apply the safety instructions.

Reminder: DO NOT vacuum hazardous substances.

### FUNCTIONS

1. Handle
2. Power switch
3. Lid latches
4. Vacuum port
5. Dust tank
6. Dolly
7. Casters
8. Flexible hose
9. Extension wand
10. Floor brush
11. Crevice nozzle
12. Foam filter
13. Disposable filter bag
14. Cartridge filter

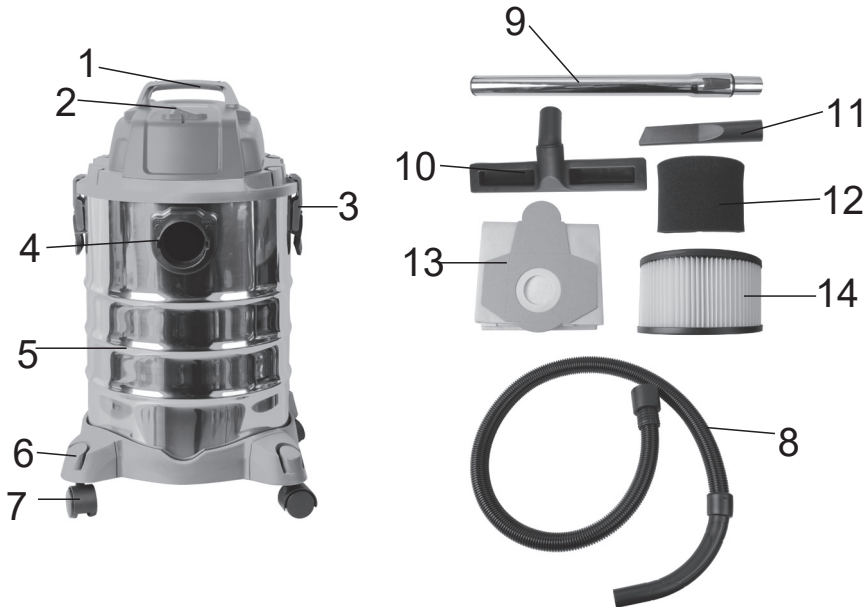

## OPERATION

### ATTENTION

Read the entire important safety information section at the beginning of this manual including all text under subheadings therein before set up or use of this product.

### UNPACKING & SET-UP SUMMARY

1. Pull lid latches in an outward motion, remove power head and some accessories that may have been shipped in the tank.
2. Attach casters following the instructions below:
  - a. Invert dust tank and align casters as shown in diagram to the right, then secure casters with provided screws.
  - b. Return dust tank to an upright position.
3. Before replacing power head, refer to this manual to ensure you have the proper filters installed for the cleaning operation.
4. Replace power head, and apply pressure with thumb to each latch until it snaps tightly in place. Make sure all lid latches are clamped securely.
5. Insert the hose end into inlet of tank.
6. Attach the extension wands to the end of the hose. Apply slight pressure until fitting is tight.
7. Attach one of the cleaning accessories (depending on the cleaning requirements) on the extension wands. Twist slightly to tighten the connection.
8. Plug the cord into the wall outlet. The cleaner is ready for use.
9. Turn the unit "ON" by pushing the switch from position "O" to position "I". The "O" is the "OFF" position and the "I" is the "ON" position.

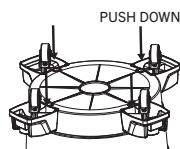

O = OFF I = ON

### WARNING

To reduce the risk of fire or explosion, do not operate this vacuum in areas with flammable gases, vapors or explosive dust in the air. Flammable gases or vapors include but are not limited to: lighter fluid, solvent-type cleaners, oil-based paints, gasoline, alcohol or aerosol sprays. Explosive dusts include but are not limited to: coal, magnesium, aluminum, and grain or gun powder. Do not vacuum explosive dust, flammable or combustible liquids or hot ashes. Do not use this vacuum as a sprayer for any flammable or combustible liquid. To reduce the risk of health hazards from vapors or dusts, do not vacuum toxic materials.

### WARNING

The operation of any utility vacuum can result in foreign objects being blown into the eyes, which can result in severe eye damage. Always wear safety eyewear complying with ANSI Z87.1 (or in Canada, CSA Z94.3) before starting operation.

### CAUTION

To reduce risk of hearing damage, wear ear protectors when using the vacuum for extended hours or when using it in a noisy area.

## DRY PICK-UP

1. The filter must always be in correct position to reduce the risk of leaks and possible damage to the vacuum. Make sure that the filter is completely covering the filter cage. Make sure there are no gaps between the filter and the lid. (See illustration). It is very important to attach the filter to the cage without allowing any possible leaks or tears. Any leaks will allow the picked up debris to be blown out of the blower port and back into the surrounding environment.

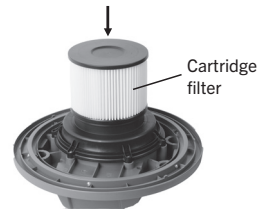

2. When using the vacuum to pick up very fine dust, it will be necessary to empty the dust tank and clean or replace the filter at more frequent intervals to maintain peak vacuum performance. Shake excess dust off filter with a rapid up and down movement.

### NOTICE

A dry filter is necessary to pick up dry material. If you use the vacuum to pick up dust when the filter is wet, the filter will clog quickly and be very difficult to clean. If the filter gets wet, replace it before continuing to do dry pickups.

## INSTALLING DISPOSABLE FILTER BAG

1. Slide the cardboard collar opening firmly onto the vacuum port deflector until it stops against the deflector wall.
2. Position the bag so that it is distributed around the inside of the tank.
3. Replace and secure the power head onto the tank.

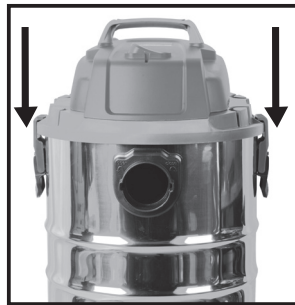

**WET PICK-UP**

1. Install a foam filter over the filter basket.

**NOTE:** WET PICK-UP ACCESSORIES SHOULD BE WASHED PERIODICALLY, ESPECIALLY AFTER PICKING UP WET, STICKY KITCHEN ACCIDENTS. THIS CAN BE ACCOMPLISHED WITH A WARM SOLUTION OF SOAP AND WATER.

2. This Wet Dry vac is equipped with a float mechanism which will rise automatically to cut off the airflow when the liquid in the tank reaches a predetermined level. When this happens, turn off vac, unplug the power cord, and empty the dust tank. You will know that the float has shut the airflow off because the suction ceases and the motor noise becomes higher in pitch due to increased motor speed. The liquid capacity may vary with the rate of pickup.

**IMPORTANT:** To reduce the risk of damage to the vacuum, do not run motor with float in raised position.

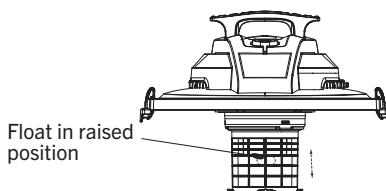
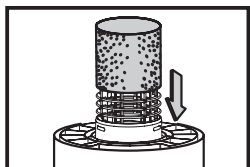

**NOTE:** IF ACCIDENTALLY TIPPED OVER, THE VACUUM COULD LOSE ITS SUCTION ABILITY. IF THIS OCCURS, PLACE VAC IN UPRIGHT POSITION AND TURN SWITCH OFF. THIS WILL ALLOW THE FLOAT TO RETURN TO ITS NORMAL POSITION, AND YOU WILL BE ABLE TO CONTINUE OPERATION.

**EMPTYING THE TANK****⚠ WARNING!**

To reduce the risk of injury from accidental starting, unplug power cord before emptying the dust tank.

1. Remove the power head assembly of the Wet Dry vacuum by pulling outward on the lid clips located on each side of the vacuum. Lift off the power head assembly.
2. Dump the tank contents into the proper waste disposal container.

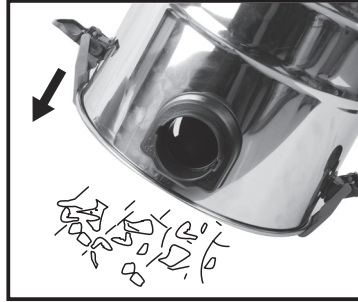
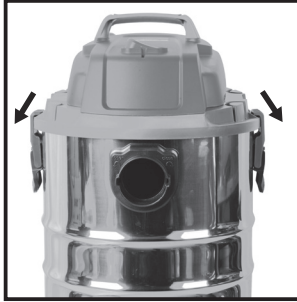

## BLOWER OPERATION

### **WARNING**

Always wear safety eyewear complying with ANSI Z87.1 (or in Canada CSA Z94.3) when using as a blower.

To avoid injury to bystanders, keep them clear of blowing debris.

### **CAUTION**

Wear a dust mask if blowing creates dust which might be inhaled. To reduce the risk of hearing damage, wear ear protectors when using the vac/blower for extended hours or in confined space.

The vacuum contains a blowing feature. Follow the steps below to use the vacuum as a blower.

1. Locate blowing port on the vacuum.
2. Insert one end of the 1 1/4" x 5ft (32mm x 1.5m) hose into the blower port.
3. Turn the vacuum "ON".



## **MAINTENANCE**

### **WARNING**

To reduce the risk of injury from accidental starting, unplug power cord before changing or cleaning filter. The filter should be cleaned often to maintain peak vacuum performance. Do not remove filter cage and float. The float prevents water from entering the impeller and damaging the motor. The cage prevents fingers from touching the moving impeller.

### **NOTICE**

To avoid damage to the impeller and motor, always reinstall the reusable filter before using the vacuum for dry pickups and always reinstall the foam filter before using the vacuum for wet pickups.

After cleaning, check the filter for tears or small holes. Do not use a filter with holes or tears in it. Even a small hole can cause dust to come out of the vacuum. Replace it immediately.

Before installing the filter on the vacuum, clean the area of the lid so that the clamp ring will seal the bag against the lid and stop small particles from bypassing the filter bag. If the filter is clean and not damaged, replace it on the filter cage. If it cannot be reused, place a new filter over the filter cage.

Clean the filter in an open area.

## **CLEANING**

To keep the Wet Dry vacuum looking its best, clean the outside with a cloth dampened with warm water and mild soap.

To clean the tank:

1. Dump out debris.
2. Wash tank thoroughly with warm water and mild soap.
3. Wipe out with dry cloth.

## **STORAGE**

Before storing the vacuum, the dust tank should be emptied and cleaned. The cord should be wrapped and hung on the unit and the accessories should be kept in the accessory holder so they can be readily available. The vacuum should be stored indoors.

## TROUBLESHOOTING

### **WARNING**

Minor problems often can be fixed without calling customer service.

| <b>PROBLEM</b>               | <b>POSSIBLE CAUSE</b>           | <b>CORRECTIVE ACTION</b>   |
|------------------------------|---------------------------------|--|
| Vacuum will not run          | No electricity                  | Make sure electrical outlet has voltage (A qualified electrician may need to be contacted) |
| Loss of suction, wet pick-up | 1. Full tank<br>2. Clogged hose | 1. Drain and clean tank<br>2. Remove hose and clean debris                                 |
| Loss of suction, dry pick-up | 1. Full tank<br>2. Clogged hose | 1. Drain and clean tank<br>2. Remove hose and clean debris                                 |

EXPLODED VIEW

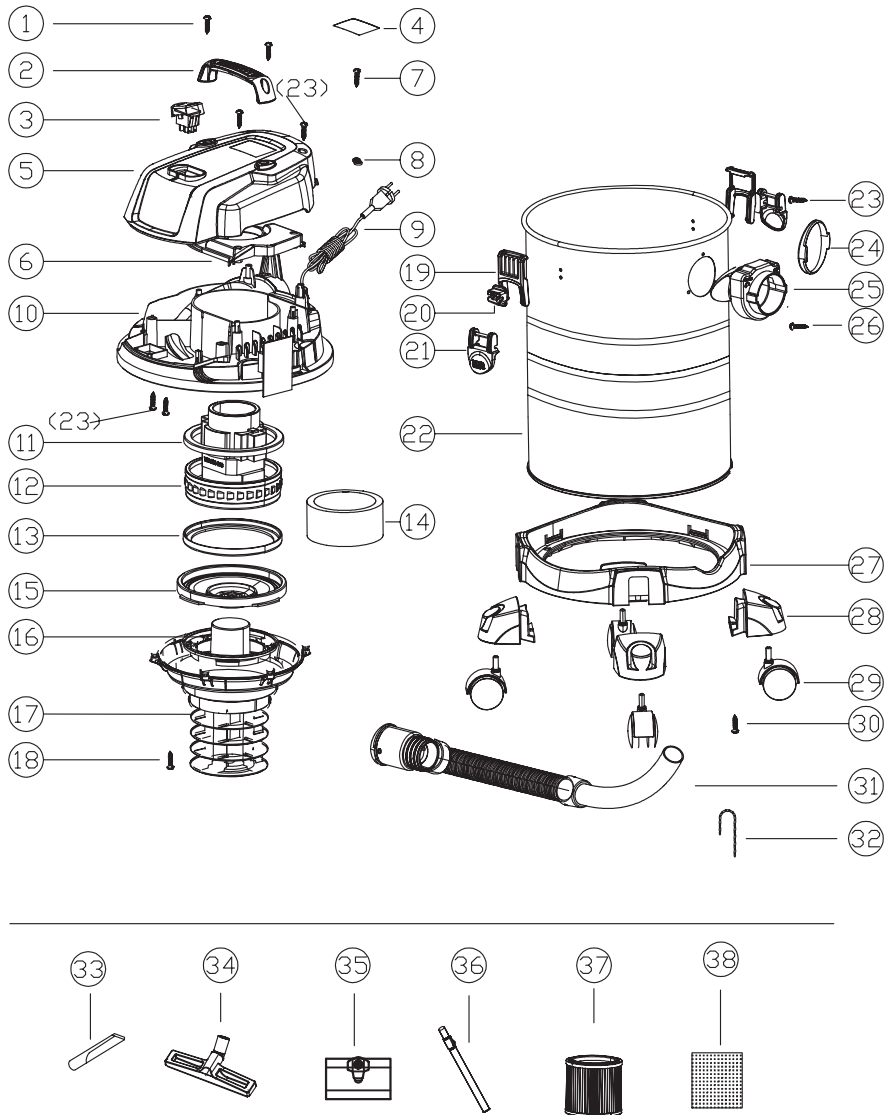

## PARTS LIST

**⚠️ WARNING** When servicing, use only original equipment replacement parts. The use of any other parts may create a safety hazard or cause damage to the Wet Dry vacuum. Any attempt to repair or replace electrical parts on this Wet Dry vacuum may create a safety hazard unless repairs are performed by a qualified technician. For more information, call the Toll-free Helpline, at 1-866-349-8665; Monday - Friday: 9am to 5pm Eastern Standard Time.

Always order by PART NUMBER, not by key number.

| Key # | Part #       | Part Name                      | Quantity |
|-------|--------------|--------------------------------|----------|
| 1     | 1277-025-001 | HANDBAR SCREW 4*16             | 2        |
| 2     | 1277-025-002 | HANDBAR                        | 1        |
| 3     | 1277-025-003 | SWITCH (2P)                    | 1        |
| 4     | 1277-025-004 | LABEL                          | 1        |
| 5     | 1277-025-005 | TOP COVER                      | 1        |
| 6     | 1277-025-006 | MOTOR COVER                    | 1        |
| 7     | 1277-025-007 | TOP COVER SCREW 4*16           | 2        |
| 8     | 1277-025-008 | POWER CORD STRAIN RELIEF       | 1        |
| 9     | 1277-025-009 | POWER CORD                     | 1        |
| 10    | 1277-025-010 | BOTTOM COVER                   | 1        |
| 11    | 1277-025-011 | TOP SEALING RING OF MOTOR      | 1        |
| 12    | 1277-025-012 | MOTOR                          | 1        |
| 13    | 1277-025-013 | BOTTOM SEALING RING OF MOTOR   | 1        |
| 14    | 1277-025-014 | MOTOR NOISE REDUCTION SPONGE   | 1        |
| 15    | 1277-025-015 | BOTTOM FRAME FOR MOTOR         | 1        |
| 16    | 1277-025-016 | SAFETY VALVE FLOAT             | 1        |
| 17    | 1277-025-017 | BOTTOM COVER BASKET            | 1        |
| 18    | 1277-025-018 | BOTTOM COVER BASKET SCREW 5*20 | 10       |
| 19    | 1277-025-019 | CLAMPS                         | 2        |
| 20    | 1277-025-020 | CLAMPS BASE                    | 2        |
| 21    | 1277-025-021 | CLAMPS HANDLE                  | 2        |
| 22    | 1277-025-022 | 30L TANK                       | 1        |
| 23    | 1277-025-023 | CLAMPS SCREW 4*12              | 6        |
| 24    | 1277-025-024 | VACUUM-INLET SETS SEALING RING | 1        |
| 25    | 1277-025-025 | VACUUM-INLET SETS              | 1        |
| 26    | 1277-025-026 | VACUUM-INLET SETS SCREW 4*16   | 3        |
| 27    | 1277-025-027 | BOTTOM BASE                    | 1        |
| 28    | 1277-025-028 | SUPPORT                        | 4        |
| 29    | 1277-025-029 | CASTERS                        | 4        |

| Key # | Part #       | Part Name                | Quantity |
|-------|--------------|--------------------------|----------|
| 30    | 1277-025-030 | CASTER SCREW 4*12        | 4        |
| 31    | 1277-025-031 | FLEX HOSE                | 1        |
| 32    | 1277-025-032 | ANTI-ELECTROSTATIC CHAIN | 1        |
| 33    | 1277-025-033 | ø32 CREVICE TOOL         | 1        |
| 34    | 1277-025-034 | WET&DRY SQUARE BRUSH     | 1        |
| 35    | 1277-025-035 | DUST BAG                 | 1        |
| 36    | 1277-025-036 | METAL TELESCOPIC TUBE    | 1        |
| 37    | 1277-025-037 | FILTER CARTRIDGE         | 1        |
| 38    | 1277-025-038 | FOAM FILTER              | 1        |

## WARRANTY

### 30L STAINLESS STEEL WET DRY VACUUM

If this Benchmark tool fails due to a defect in material or workmanship within five years from the date of purchase, return it to any Home Hardware store with the original bill of sale for exchange. 3-year warranty for the battery and charger. This warranty does not include expendable parts including but not limited to blades, brushes, belts, light bulbs.

This warranty covers defects in material or workmanship only. It does not cover normal wear and tear, failure due to abuse/misuse, or defects caused by careless or accidental mishandling. If this Benchmark product is used for commercial or rental purposes, this warranty does not apply.

***\*Wet/Dry vacuums used without a filter made of HEPA-rated material to extract drywall dust, will void the warranty.***

# 30L STAINLESS STEEL WET DRY VACUUM



5 year limited warranty

**BENCHMARK™**  
MC

**BENCHMARK TOOLS CANADA**

ST. JACOBS, ONTARIO N0B 2N0

© 2022 Home Hardware Stores Limited

**CUSTOMER SERVICE/TECH SUPPORT**

1-866-349-8665

**1277-025**

Made in China



\*This Benchmark™ product carries a five (5) year LIMITED warranty against defects in workmanship and materials. See Owner's Manual for full details.



Intertek  
5002219  
JN308

**READ ALL INSTRUCTIONS BEFORE FIRST USE.  
KEEP THIS MANUAL FOR FUTURE REFERENCE.  
KEEP AWAY FROM CHILDREN.**

Wet/Dry vacuums used without a filter made of HEPA-rated material to extract drywall dust, will void the warranty.



**WEAR CSA APPROVED  
EYE PROTECTION**



**WEAR EAR  
PROTECTION**



**WEAR A  
FACE MASK**