

# BENCHMARK<sup>TM</sup> MC

## 20 L STAINLESS STEEL WET/DRY VACUUM



120V 60Hz 8.5Amp  
5 Year Limited Warranty on tool



Intertek  
5002219  
JN302

**READ ALL INSTRUCTIONS BEFORE FIRST USE.  
KEEP THIS MANUAL FOR FUTURE REFERENCE.  
KEEP AWAY FROM CHILDREN.**

Wet/Dry vacuums used without a filter made of HEPA-rated material to extract very fine dust, such as drywall dust, will void the warranty.



**WEAR CSA APPROVED  
EYE PROTECTION**



**WEAR EAR  
PROTECTION**



**WEAR A  
FACE MASK**

## PRODUCT SPECIFICATIONS

20L STAINLESS STEEL WET/DRY VACUUM	
Voltage	120V~ 60Hz
Rated Power	8.5A 5.5Peak HP
Tank Capacity	5.25Gal (20L)
Flexi Hose	1 1/4" x 5ft (32mm x 1.5m)
Flow Rate	60CFM
Power Cord	13.13ft. (4m)
Optional Cartridge Filter (sold separately)	1277-035
Replacement Collection Bag	1277-030
Replacement foam filter sleeve	1277-047
HEPA cartridge filter (sold separately)	1277-037
Weight	12.32LBS (5.6KGS)

When using an extension cord with your Wet/Dry Vac refer to the following table to determine the required AWG wire size. Before using the cleaner make sure the power cord and extension cord are in good working conditions. Make repairs or replacements before using the vacuum cleaner. Only use extension cords that are rated for outdoor use.

LENGTH OF EXTENSION CORD				
110V-120V	25' (7.5 m)	50' (15.25 m)	100' (30.5 m)	150' (45.7 m)
Amps	AWG Wire Size			
0-6	18	16	16	14
7-10	18	16	14	12
11-12	16	16	14	12
13-16	14	12	Not recommended	

### NEED ASSISTANCE?

Call us on our toll-free customer support line:  
1-866-349-8665 (Monday through Friday 9am – 5pm Eastern Standard Time)

- Technical questions
- Replacement parts
- Parts missing from package

## TABLE OF CONTENTS

Product Specifications .....	1
Table of Contents .....	2
General Safety Warnings .....	3
Important Safety Instructions .....	3
Safety Symbols .....	3
Specific Safety Instructions for 20l Stainless Steel Wet/Dry Vacuum .....	3 - 6
Know Your Wet/Dry Vacuum .....	6
Operation .....	7
Unpacking and Set-Up Summary .....	7
Dry Pick-Up .....	8
Installing Disposable Filter Bag .....	8
Wet Pick-Up .....	9
Emptying the Tank .....	9
Blowing Operation .....	10
Maintenance .....	11
Cleaning .....	11
Storage .....	11
Troubleshooting .....	11
Exploded View .....	12
Parts List .....	13
Warranty .....	14





## GENERAL SAFETY WARNINGS

### IMPORTANT SAFETY INSTRUCTIONS

Read and understand all safety and operational instructions. Failure to follow the safety rules listed below and other basic safety precautions may result in serious personal injury. Keep this manual, sales receipts, and applicable warranty forms for future reference.

### SAFETY SYMBOLS

The purpose of safety symbols is to alert you of the potential safety RISKS. Recognize and understand them. Follow the instructions provided.

SYMBOL	MEANING
	Failure to obey a <b>DANGER</b> safety alert <b>WILL</b> result in serious personal injury or death to you or to others. Always obey all messages following this symbol to reduce the risk of serious personal injury or death.
	Failure to obey a <b>WARNING</b> safety alert <b>MAY</b> result in serious personal injury or death to you or to others. Always obey all messages following this symbol to reduce the risk of potential serious personal injury or death.
	Failure to obey a <b>CAUTION</b> safety alert <b>MAY</b> result in personal injury or property damage to you or to others. Always obey all messages following this symbol to reduce the risk of personal injury or property damage.
	Failure to obey a <b>NOTICE</b> or a <b>CAUTION</b> (without a safety alert) <b>MAY</b> result in property damage to you or to others. Always obey all messages following this symbol to reduce the risk of property damage.

## SPECIFIC SAFETY INSTRUCTIONS FOR 20L STAINLESS STEEL WET/DRY VACUUM

### SAVE THIS MANUAL FOR FUTURE REFERENCE

- Read all instructions before using this appliance.
- Read and understand this instruction manual and all labels on the Wet/Dry Vacuum before using.
- Safety is a combination of common sense, staying alert and knowing how this Wet/Dry Vacuum works. Use this Wet/Dry Vacuum only as described in this manual. To reduce the risk of personal injury or damage to the Wet/Dry Vacuum, use only recommended accessories.

When using this Wet/Dry Vacuum follow basic safety precautions including the following:

**TO REDUCE THE RISK OF FIRE, ELECTRIC SHOCK OR INJURY:**

- Do not run the Wet/Dry Vacuum unattended.
- Do not vacuum, or use this Wet/Dry Vacuum near liquids, gases, or explosive vapours like gasoline or similar fuels, lighter fluid, cleaners, oil based paints, natural gas or hydrogen. Do not vacuum or use this Wet/Dry Vacuum near explosive dusts like coal dust, magnesium dust, grain dust, or gunpowder as sparks inside the motor can ignite flammable vapours or dust.
- Do not vacuum burning or smoking items such as cigarettes, matches, or hot ashes.
- Keep the cord away from heated surfaces.
- Do not expose to rain. Store indoors.
- Do not unplug by pulling on cord. To unplug, grasp the plug, not the cord.
- Do not use if the cord, plug or other parts are damaged.
- If the Wet/Dry Vacuum is not working correctly or has missing parts, has been dropped or damaged, left outdoors or dropped in water, return it to an independent service centre.
- Do not pull or carry by the cord. Do not use the cord as a handle, close a door on the cord, or pull the cord around sharp edges or corners.
- Do not run the Wet/Dry Vacuum over the cord.
- Do not handle the plug or the Wet/Dry Vacuum with wet hands.
- To reduce the risk of health hazards from vapours or dusts, do not vacuum toxic materials.
- Do not use or store near hazardous materials.
- Do not use this Wet/Dry Vacuum with a torn filter or without installing the filter except when vacuuming liquids as described in the operation section of this manual.
- Do not use the Wet/Dry Vacuum as a toy. Pay particularly close attention when it is being used by or near children.
- To reduce the risk of injury from the Wet/Dry Vacuum accidentally starting, unplug the power cord before changing or cleaning the filter.
- Do not leave the Wet/Dry Vacuum unattended when it is plugged in. Unplug it from the power outlet when not in use and before servicing. Turn off the Wet/Dry Vacuum before unplugging.
- Do not put any objects into the ventilation openings. Do not vacuum with the ventilation openings blocked.
- Keep free of dust, lint, hair or any other items that may reduce the air flow.
- Keep hair, loose clothing, fingers, and all body parts away from openings and moving parts.
- To reduce the risk of falling, use extra care when cleaning on stairs.

## WHEN USING AS BLOWER:

- Direct air discharge only at work area.
- Do not use Wet/Dry Vacuum as a sprayer.
- Do not direct air at bystanders.
- Keep children away when blowing.
- Wear safety goggles.

This Wet/Dry Vacuum is double-insulated, eliminating the need for a separate grounding system. Use only identical replacements parts. Read the servicing instructions before servicing the Wet/Dry Vacuum.

Use this Wet/Dry Vacuum only as described in this manual.

Observe the following warnings that appear on the motor housing of this Wet/Dry Vacuum.

### **WARNING: SERVICING OF A DOUBLE-INSULATED WET/DRY VACUUM**

In a double-insulated Wet/Dry Vacuum, two systems of insulation are provided instead of grounding. This means that no grounding is provided on a double-insulated appliance, nor should a means for grounding be added. Servicing a double-insulated Wet/Dry Vacuum requires extreme care and knowledge of the system and should be done only by qualified service personnel. Replacement parts for a double-insulated Wet/Dry Vacuum must be identical to the parts they replace. The double-insulated Wet/Dry Vacuum is marked with the words "DOUBLE INSULATED" and the symbol  may also be marked on the appliance.

- For household use only.
- To reduce the risk of electric shock, unplug before cleaning or servicing.
- DO NOT use without filters in place.
- To reduce the risk of electric shock, use indoors only.

 **WARNING:** If the supply cord is damaged, it must be replaced by the manufacturer or its service agent or a similarly qualified person in order to avoid a hazard.

 **WARNING:** Remove the plug from the socket before performing maintenance. Before using the machine make sure that the frequency and voltage shown on the rating plate correspond with the mains voltage. Specifications and details are subject to change without prior notice. The accessories shown in the pictures may vary from model to model.

 **WARNING:** For your own safety, read and understand this instruction manual. Do not operate unattended. Do not use this Wet/Dry Vacuum to pick up hot ashes, coals, toxic, flammable or other hazardous materials. Do not use near explosive liquids or vapours.

 **WARNING:** To reduce the risk of electric shock, do not expose to rain. Store indoors.

**⚠ CAUTION:** Do not vacuum drywall dust or cold fireplace soot or ash with a standard wet/dry filter. This dust is very fine and hence will not be captured by the filter and may cause damage. Refer to the operation section for proper filter selection.

**⚠ WARNING: SERVICING OF DOUBLE-INSULATED WET/DRY VACUUM.**

**⚠ CAUTION:** To reduce the risk of injury from moving parts, unplug before servicing.

**SAVE THIS USER MANUAL**

**⚠ WARNING: MISUSE** or failure to follow the safety rules stated in this instruction manual may cause serious personal injury.

**KNOW YOUR WET/DRY VACUUM**

**⚠ ATTENTION:** Before starting please read, understand, and apply the safety instructions. Reminder: **DO NOT** vacuum hazardous substances.

**FUNCTIONS**

- |                 |                   |                           |
|-----------------|-------------------|---------------------------|
| 1. Handle       | 6. Dolly          | 11. Crevice Nozzle        |
| 2. Power Switch | 7. Casters        | 12. Foam Filter           |
| 3. Lid Latches  | 8. Flexible Hose  | 13. Disposable Filter Bag |
| 4. Vacuum Port  | 9. Extension Wand |                           |
| 5. Dust Tank    | 10. Floor Brush   |                           |



## OPERATION

**⚠ ATTENTION:** Read the entire important safety information section at the beginning of this manual including all text under subheadings therein before set up or use of this product.

### UNPACKING AND SET-UP SUMMARY

1. Pull lid latches in an outward motion, remove power head and some accessories that may have been shipped in the tank.
2. Attach caster following the instructions as below:
  - a. Invert dust tank and align casters as shown in diagram to the right, then secure casters with provided screws.
  - b. Return dust tank to an upright position.
3. Before replacing power head, refer to this manual to ensure you have the proper filters installed for the cleaning operation.
4. Replace power head, and apply pressure with thumb to each latch until it snaps tightly in place. Make sure all lid latches are clamped securely.
5. Insert the hose end into inlet of tank.
6. Attach the extension wands to the end of the hose. Apply slight pressure until fitting is tight.
7. Attach one of the cleaning accessories (depending on the cleaning requirements) on the extension wands.  
Twist slightly to tighten the connection.
8. Plug the cord into the wall outlet. The cleaner is ready for use.
9. Turn the unit "ON" by pushing the switch from position "O" to position "I". The "O" is the "OFF" position and the "I" is the "ON" position.

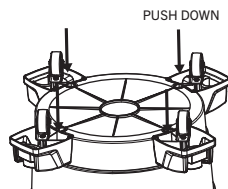

O = OFF I=ON

**⚠ WARNING:** To reduce the risk of fire or explosion, do not operate this vacuum in areas with flammable gases, vapors or explosive dust in the air. Flammable gases or vapors include but are not limited to: lighter fluid, solvent-type cleaners, oil-based paints, gasoline, alcohol or aerosol sprays. Explosive dusts include but are not limited to: coal, magnesium, aluminum, and grain or gun powder. Do not vacuum explosive dust, flammable or combustible liquids or hot ashes. Do not use this vacuum as a sprayer for any flammable or combustible liquid. To reduce the risk of health hazards from vapors or dusts, do not vacuum toxic materials.



**⚠️ WARNING:** The operation of any utility vacuum can result in foreign objects being blown into the eyes, which can result in severe eye damage. Always wear safety eyewear complying with ANSI Z87.1 (or in Canada, CSA Z94.3) before starting operation.

**⚠️ CAUTION:** To reduce risk of hearing damage, wear ear protectors when using the vacuum for extended hours or when using it in a noisy area.

### DRY PICK-UP

1. Install a foam filter over the filter basket.
2. When using the vacuum to pick up very fine dust, such as drywall dust, it will be necessary to replace cartridge filter with a 1277-037 HEPA FILTER (sold separately), empty the dust tank and clean or replace the filter at more frequent intervals to maintain peak vacuum performance. Shake excess dust off cartridge filter with a rapid up and down movement. Wet/Dry vacuums used without a filter made of HEPA-rated material to extract very fine dust such as drywall dust, will void the warranty.

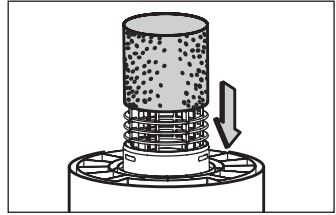

**⚠️ NOTICE:** A dry filter is necessary to pick up dry material. If you use the vacuum to pick up dust when the filter is wet, the filter will clog quickly and be very difficult to clean. If the filter gets wet, replace it before continuing to do dry pickups. Shake excess dust off filter with a rapid up and down movement.

### INSTALLING DISPOSABLE FILTER BAG

1. Slide the cardboard collar opening firmly onto the vacuum port deflector until it stops against the deflector wall.
2. Position the bag so that it is distributed around the inside of the tank.
3. Replace and secure the power head onto the tank.

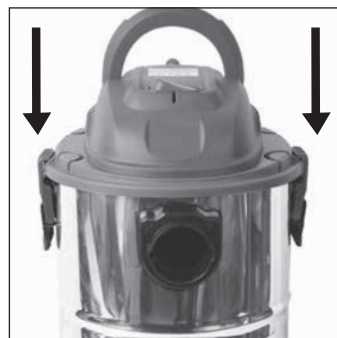

## WET PICK-UP

1. Install a foam filter over the filter basket.

**NOTE: Wet pick-up accessories should be washed periodically, especially after picking up wet, sticky kitchen accidents. This can be accomplished with a warm solution of soap and water.**

2. This wet/dry vacuum is equipped with a float mechanism which will rise automatically to cut off the airflow when the liquid in the tank reaches a predetermined level. When this happens, turn off vacuum, unplug the power cord, and empty the dust tank. You will know that the float has shut the airflow off because the suction ceases and the motor noise becomes higher in pitch due to increased motor speed. The liquid capacity may vary with the rate of pickup.

**IMPORTANT:** To reduce the risk of damage to the vacuum, do not run motor with float in raised position.

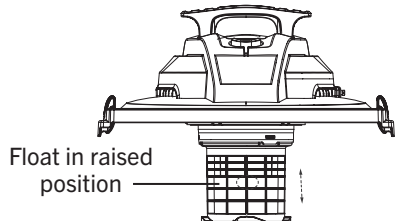
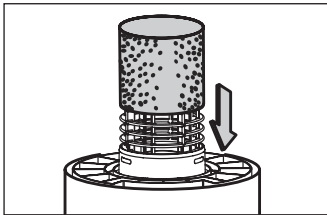

**⚠ NOTICE: If accidentally tipped over, the vacuum could lose its suction ability. If this occurs, place vacuum in upright position and turn switch off. This will allow the float to return to its normal position, and you will be able to continue operation.**

## EMPTYING THE TANK

**⚠ WARNING:** To reduce the risk of injury from accidental starting, unplug power cord before emptying the dust tank.

1. Remove the power head assembly of the wet/dry vacuum by pulling outward on the lid clips located on each side of the vacuum. Lift off the power head assembly.
2. Dump the tank contents into the proper waste disposal container.

**BLOWING OPERATION**

**⚠ WARNING:** Always wear safety eyewear complying with ANSI Z87.1 (or in Canada CSA Z94.3) when using as a blower.

To avoid injury to bystanders, keep them clear of blowing debris.

**⚠ CAUTION:** Wear a dust mask if blowing creates dust which might be inhaled. To reduce the risk of hearing damage, wear ear protectors when using the vacuum/blower for extended hours or in confined space.

The vacuum contains a blowing feature. Follow the steps below to use the vacuum as a blower.

1. Locate blowing port on the vacuum.
2. Insert one end of the 1-1/4" x 4.9' ( 32mm x 1.5m) hose into the blower port.
3. Turn the vacuum "ON".



## MAINTENANCE

**⚠️ WARNING:** To reduce the risk of injury from accidental starting, unplug power cord before changing or cleaning the foam filter. The foam filter should be cleaned often to maintain peak vacuum performance. Do not remove filter cage and float. The float prevents water from entering the impeller and damaging the motor. The cage prevents fingers from touching the moving impeller.

**⚠️ NOTICE:** To avoid damage to the impeller and motor, always reinstall the reusable foam filter before using the vacuum for dry pickups and always reinstall the foam filter before using the vacuum for wet pickups.

After cleaning, check the filter for tears or small holes. Do not use a foam filter with holes or tears in it. Even a small hole can cause dust to come out of the vacuum. Replace it immediately. Before installing the foam filter on the vacuum, clean the area of the lid so that the clamp ring will seal the bag against the lid and stop small particles from bypassing the filter bag. If the foam filter is clean and not damaged, replace it on the filter cage. If it cannot be reused, place a new foam filter over the filter cage.

Clean the filter in an open area.

### CLEANING

To keep the wet/dry vacuum looking its best, clean the outside with a cloth dampened with warm water and mild soap.

To clean the tank:

1. Dump out debris.
2. Wash tank thoroughly with warm water and mild soap.
3. Wipe out with dry cloth.

### STORAGE

Before storing the vacuum, the dust tank should be emptied and cleaned. The cord should be wrapped and hung on the unit and the accessories should be kept in the accessory holder so they can be readily available. The vacuum should be stored indoors.

## TROUBLESHOOTING

**⚠️ WARNING:** Minor problems often can be fixed without calling customer service.

PROBLEM	POSSIBLE CAUSE	CORRECTIVE ACTION
Vacuum will not run	No electricity	Make sure electrical outlet has voltage (A qualified electrician may need to be contacted)
Loss of suction, wet pick-up	1. Full tank 2. Clogged hose	1. Drain and clean tank 2. Remove hose and clean debris
Loss of suction, dry pick-up	1. Full tank 2. Clogged hose	1. Drain and clean tank 2. Remove hose and clean debris

**EXPLODED VIEW**

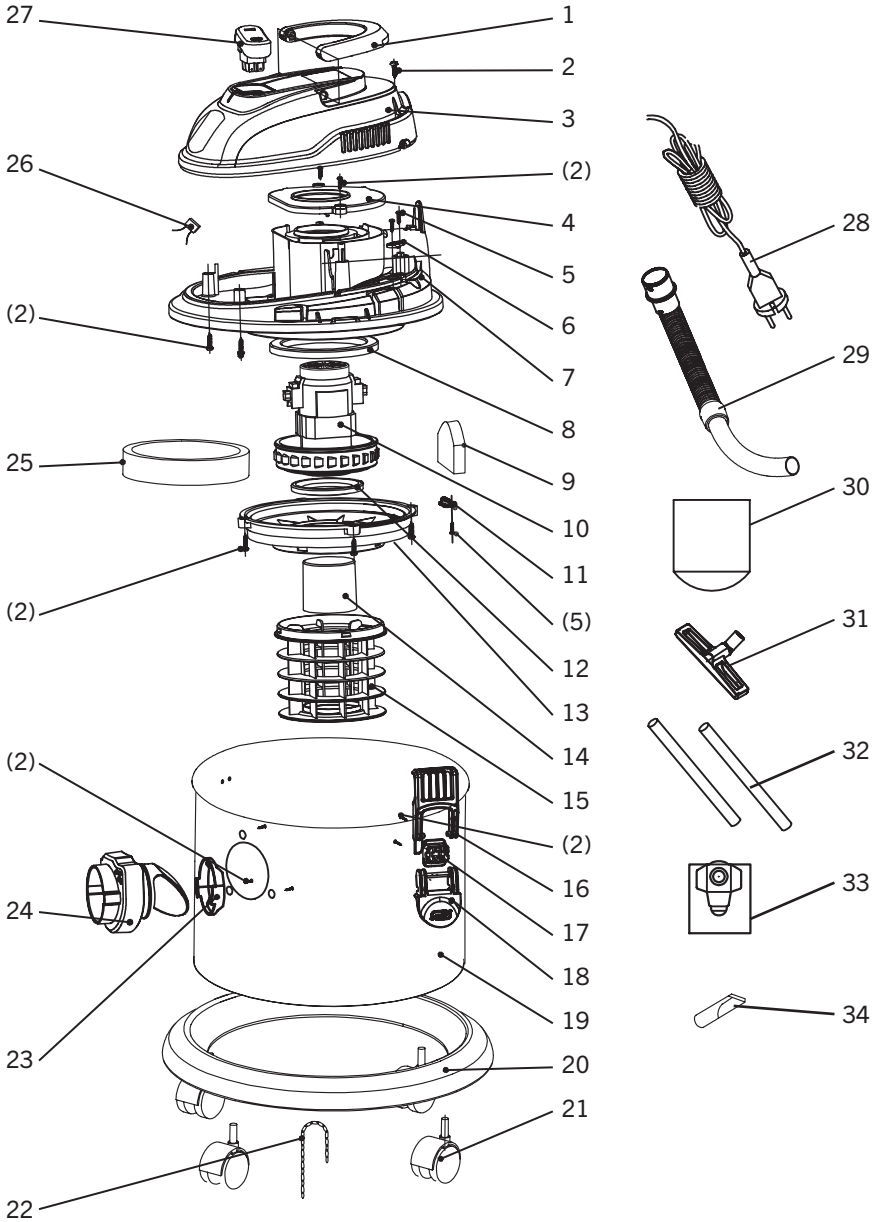

## PARTS LIST

Always order by key number.

KEY #	PART #	PART NAME / QUANTITY	KEY #	PART #	PART NAME / QUANTITY
1	1277-023-001	Handle / 1	18	1277-023-018	Clamps Handle / 2
2	1277-023-002	Handle Screws 4*16 / 15	19	1277-023-019	Tank 20L / 1
3	1277-023-003	Top Cover / 1	20	1277-023-020	Base / 1
4	1277-023-004	Motor Top Cover / 1	21	1277-023-021	Wheels / 4
5	1277-023-005	Handle Screws 4*12 / 7	22	1277-023-022	Electrostatic Chain / 1
6	1277-023-006	Power Cord Strain Relief / 1	23	1277-023-023	Air-Inlet Base Sealing Ring / 1
7	1277-023-007	Bottom Cover / 1	24	1277-023-024	Vacuum Port / 1
8	1277-023-008	Motor Top Sealing Ring / 1	25	1277-023-025	Motor Filter / 1
9	1277-023-009	Outlet Hole Filter / 1	26	1277-023-026	Capacitance / 1
10	1277-023-010	Motor / 1	27	1277-023-027	Switch / 1
11	1277-023-011	Motor Bottom Plug / 1	28	1277-023-028	Power Cord 4m / 1
12	1277-023-012	Motor Bottom Sealing Ring / 1	29	1277-023-029	Ø 32 Hose 1.5m / 1
13	1277-023-013	Bottom Hole Cover / 2	30	1277-023-030	Foam Filter / 1
14	1277-023-014	Safety Valve / 1	31	1277-023-031	Ø 32 Wet&Dry Brush / 1
15	1277-023-015	Bottom Cover Basket / 1	32	1277-023-032	Plastic Tube Extensions / 2
16	1277-023-016	Clamps / 2	33	1277-023-033	Dustbag 20L / 1
17	1277-023-017	Clamps Base / 2	34	1277-023-034	Ø 32 Small Crevice Nozzle / 1

**⚠ WARNING:** When servicing, use only original equipment replacement parts. The use of any other parts may create a safety hazard or cause damage to the wet/dry vacuum. Any attempt to repair or replace electrical parts on this wet/dry vacuum may create a safety hazard unless repairs are performed by a qualified technician. For more information, call the Toll-free Helpline, at 1-866-349-8665; Monday - Friday: 9am to 5pm Eastern Standard Time.

## WARRANTY

### 20L STAINLESS STEEL WET/DRY VACUUM

If this Benchmark tool fails due to a defect in material or workmanship within five years from the date of purchase, return it to any Home Hardware store with the original bill of sale for exchange. 3-year warranty for the battery and charger. This warranty does not include expendable parts including but not limited to blades, brushes, belts, light bulbs.

This warranty covers defects in material or workmanship only. It does not cover normal wear and tear, failure due to abuse/misuse, or defects caused by careless or accidental mishandling. If this Benchmark product is used for commercial or rental purposes, this warranty does not apply.

*\*Wet/Dry vacuums used without a filter made of HEPA-rated material to extract very fine dust, such as drywall dust, will void the warranty.*







# 20 L STAINLESS STEEL WET/DRY VACUUM



5 Year Limited Warranty on tool

**BENCHMARK**<sup>TM</sup><sub>MC</sub>

**BENCHMARK TOOLS CANADA**  
ST. JACOBS, ONTARIO N0B 2N0  
© 2023 Home Hardware Stores Limited

**CUSTOMER SERVICE/TECH SUPPORT**  
1-866-349-8665

**1277-023**

Made in China



\* This Benchmark<sup>TM</sup> product carries a five (5) year LIMITED warranty against defects in workmanship and materials. See Owner's Manual for full details.



**Intertek**  
5002219  
JN302

**READ ALL INSTRUCTIONS BEFORE FIRST USE.  
KEEP THIS MANUAL FOR FUTURE REFERENCE.  
KEEP AWAY FROM CHILDREN.**

Wet/Dry vacuums used without a filter made of HEPA-rated material to extract very fine dust, such as drywall dust, will void the warranty.



**WEAR CSA APPROVED  
EYE PROTECTION**



**WEAR EAR  
PROTECTION**



**WEAR A  
FACE MASK**