

BENCHMARKTM MC

18 L ASH VACUUM



120V 60Hz 7.5Amp
5 Year Limited Warranty on tool



Intertek
5002219
JN019

**READ ALL INSTRUCTIONS BEFORE FIRST USE.
KEEP THIS MANUAL FOR FUTURE REFERENCE.
KEEP AWAY FROM CHILDREN.**

Not suitable for ultra-fine collection such as drywall dust.
Such use will void the warranty.



**WEAR CSA APPROVED
EYE PROTECTION**



**WEAR EAR
PROTECTION**



**WEAR A
FACE MASK**

PRODUCT SPECIFICATIONS

18 L ASH VACUUM	
Voltage	120V~ 60Hz
Rated Power	7.5A 6HP
Tank Capacity	18 L 4.7 Gallon
Hose	Metal wire reinforced hose: 39.37" (1m) 3-1/4 Ft.; Aluminum tube: 9.06" (23cm);
Max Temp of Material	Below 40 C (104 °F) If temp of the vacuuming material exceeds this temp, there is a risk of fire
Power Cord	10ft. (3m)
Replacement Cartridge Filter	1277-300
Weight	7.3lbs, (3.3kg)

NEED ASSISTANCE?

Call us on our toll-free customer support line:
1-866-349-8665 (Monday through Friday 9am – 5pm Eastern Standard Time)

- Technical questions
- Replacement parts
- Parts missing from package

TABLE OF CONTENTS

Product Specifications	1
Table of Contents	2
General Safety Warnings	3
Safety Symbols	3
Specific Ash Vacuum Safety Instructions	3 - 5
Know Your 18 L Ash Vacuum	6
Assembly	7
Electrical Info & Specifications	7
Double Insulation	7
Extension Cords	7
Unpacking Your Vacuum	8
Installing Hose & Aluminum Nozzle For Vacuuming Mode	8
Installing Hose & Aluminum Nozzle For Blower Mode	8
Operation	9
Maintenance	10
Exploded View	11
Parts List	12
Warranty	13





GENERAL SAFETY WARNINGS

IMPORTANT SAFETY INSTRUCTIONS

Read and understand all safety and operational instructions. Failure to follow the safety rules listed below and other basic safety precautions may result in serious personal injury. Keep this manual, sales receipts, and applicable warranty forms for future reference.

SAFETY SYMBOLS

The purpose of safety symbols is to alert you of the potential safety RISKS. Recognize and understand them. Follow the instructions provided.

SYMBOL	MEANING
	Failure to obey a DANGER safety alert WILL result in serious personal injury or death to you or to others. Always obey all messages following this symbol to reduce the risk of serious personal injury or death.
	Failure to obey a WARNING safety alert MAY result in serious personal injury or death to you or to others. Always obey all messages following this symbol to reduce the risk of potential serious personal injury or death.
	Failure to obey a CAUTION safety alert MAY result in personal injury or property damage to you or to others. Always obey all messages following this symbol to reduce the risk of personal injury or property damage.
	Failure to obey a NOTICE or a CAUTION (without a safety alert) MAY result in property damage to you or to others. Always obey all messages following this symbol to reduce the risk of property damage.

SPECIFIC ASH VACUUM SAFETY INSTRUCTIONS

Household Type

READ AND UNDERSTAND ALL INSTRUCTIONS BEFORE USING THIS VACUUM.

Read and understand this operator's manual and all labels on the Ash Vacuum cleaner before operating. Safety is a combination of common sense, staying alert and knowing how your vacuum works. Use this Ash Vacuum only as described in this manual. To reduce the risk of personal injury or damage to your Ash Vacuum, use only manufacturer recommended accessories. For Household Use Only.

 **WARNING:** The temperature of the vacuuming material must be below 40°C (104°F). If temperature of the vacuuming material exceeds 40°C (104°F), there is a risk of fire.

 **CAUTION:** Never use this product for vacuuming liquids. Only use this unit to vacuum dry dust material!

SAVE THIS MANUAL

 **WARNING: For future reference.** When using a vacuum, basic precautions should always be followed including the following:

 **WARNING: To reduce the risk of fire, electric shock, or injury:**

- Do not run vacuum unattended
- Do not use to pick up flammable or combustible liquids, such as gasoline, or use in areas where they may be present.
- Do not vacuum, or use this Ash vacuum near flammable liquids, gases, or explosive vapors like gasoline or other fuels, lighter fluids, cleaners, oil-based paints, natural gas, hydrogen, or explosive dusts like coal dust, magnesium dust, grain dust, or gun powder. Sparks inside the motor can ignite flammable vapors or dust.
- To reduce the risk of health hazards from vapors or dusts, do not vacuum toxic materials.
- Do not use or store near hazardous materials.
- Do not pick up anything that is burning or smoking, such as cigarettes, matches, or hot ashes. Cold ash only.
- Do not expose to rain. Store indoors
- If vacuum is not working as it should, has been dropped, damaged, left outdoors, or dropped into water, return it to a service center.
- Do not unplug by pulling on cord. To unplug, grasp the plug, not the cord.
- Do not use with damaged cord or plug.
- Do not pull or carry by cord, use cord as a handle, close a door on cord, or pull cord around sharp edges or corners.
- Keep cord away from heated surfaces.
- Do not handle plug or vacuum with wet hands
- Do not use without filter in place
- Do not allow to be used as a toy. Close attention is necessary when used by or near children.
- To reduce the risk of injury from accidental starting, unplug power cord before changing or cleaning filter.
- Do not leave vacuum when plugged in. Unplug from outlet when not in use and before servicing.
- Turn off all controls before unplugging.
- Unplug before connecting or disconnecting hose, or any other accessories.
- Do not put any object into openings. Do not use with any opening blocked; keep free of dust, lint, hair, and anything that may reduce air flow.
- Keep hair, loose clothing, fingers, and all parts of body away from openings and moving parts.

- Use extra care when cleaning on stairs
- Use only as described in this manual. Use only manufacturer's recommended attachments.
- This vacuum is provided with double insulation. Use only identical replacement parts.

See DOUBLE INSULATION INSTRUCTIONS.

⚠ CAUTION: To reduce the risk of injury from moving parts - Unplug before servicing.

⚠ WARNING: To reduce the risk of electric shock - Unplug before cleaning or servicing.

DOUBLE INSULATION INSTRUCTIONS

This Ash Vacuum is double insulated, eliminating the need for a separate grounding system. Use only identical replacement parts. Read the instructions for Servicing Double Insulated Ash Vacuum before servicing. Use this Ash Vacuum as described in this manual. Observe the following warnings for your Ash Vacuum.

DOUBLE INSULATED - GROUNDING NOT REQUIRED - WHEN SERVICING USE ONLY IDENTICAL REPLACEMENT PARTS.

⚠ WARNING: To reduce the risk of electric shock -do not expose to rain. Store indoors.

⚠ WARNING: For your own safety, read and understand operator's manual. Do not run unattended. Do not pick up hot ashes, coals, toxic, flammable or other hazardous materials. Do not use around explosive liquids or vapors.

⚠ WARNING: Servicing of double insulated ash vacuum, two systems of insulation are provided instead of grounding. No grounding means is provided on a double insulated appliance, nor should a means for grounding be added. Servicing a Double insulated ash vacuum requires extreme care and knowledge of the System, and should be done only by qualified service personnel. Replacement Parts for a double insulated ash vacuum must be identical to the parts they Replace.

SAVE THIS USER MANUAL

⚠ WARNING: MISUSE or failure to follow the safety rules stated in this instruction manual may cause serious personal injury.

KNOW YOUR 18 L ASH VACUUM

⚠️ WARNING: Before starting please read, understand, and apply the safety instructions. Reminder: DO NOT vacuum hazardous substances.

FUNCTIONS

- | | | |
|-------------------------|------------------|---|
| 1. Tank | 5. Carry Handle | 9. Inlet Port |
| 2. Cover/Motor Assembly | 6. Blower Port | 10. Aluminum nozzle |
| 3. Cover Latch (2) | 7. On/Off Switch | 11. Cartridge filter
(installed inside tank) |
| 4. Power Cord | 8. Hose | |



ASSEMBLY

⚠ ATTENTION: Read the entire important safety information section at the beginning of this manual including all text under subheadings therein before set up or use of this product.

ELECTRICAL INFO & SPECIFICATIONS

POWER SUPPLY- WARNING: Your vacuum must be connected to a 120v, minimum 15-amp. Branch circuit. Failure to connect in this way can result in injury from shock or fire.

DOUBLE INSULATION

Double insulated tools are equipped with a polarized two-prong plug (one blade is wider than the other). This plug will fit in a polarized outlet only one way. If the plug does not fit fully into the outlet, reverse the plug. If it still does not fit, contact a qualified electrician to install a polarized outlet. Do not alter or change the plug in any way. Double insulation eliminates the need for three wire grounded power supply and grounded power cords.

120V OPERATION As received from the factory, your vacuum is ready to run for 120V operation. This vacuum is intended for use on a circuit that has an outlet and a plug which looks like the one illustrated in Fig.1

EXTENSION CORDS

Improper use of extension cords may cause inefficient operation of your tool which can result in overheating. Be sure your extension cord is rated to allow sufficient current flow to the motor. If you are using the tool outdoors, use an extension cord rated for outdoor use (signified by "SJW or SJTW" on the jacket). The extension cord must have a minimum wire size depending on the amperage of the tool and the length of the extension cord. This size is determined by its AWG (American Wire Gauge) rating. The smaller the gauge, the greater the cable's capacity. The amount of cords used does not matter: Total length determines the minimum AWG rating. Every cord must meet the AWG rating. Use the chart in Fig.2 to determine what AWG rating is required for your situation.

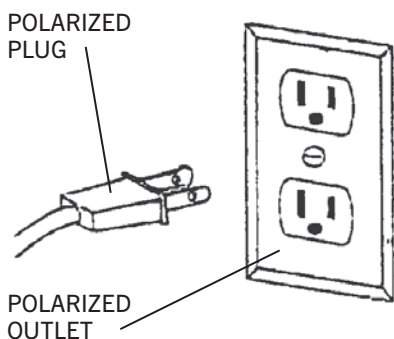

FIG. 1

Tool's Amperage Rating	Cord Size in A.W.G.			
	Cord Length in Feet			
	25	50	100	150
3-6	18	16	16	14
6-8	18	16	14	12
8-10	18	16	14	12
10-12	18	16	14	12
12-16	14	12	-	-

FIG. 2

⚠ ATTENTION: The vacuum accessories are packed inside the vacuum tank.

UNPACKING YOUR VACUUM

Remove the entire contents of the carton, please note that the accessories are packed inside the vacuum tank. To access these accessories, undo the latches (A) Fig.3 on both sides of the tank, remove the tank cover/motor assembly (B), then remove the accessories inside the tank (C).



FIG. 3

⚠ WARNING: Do not connect the power cord to the power source until the following assembly and set-up instructions have been done. **Installing filter**

Before reinstalling the cover/motor assembly on, make sure the included cartridge filter (A) Fig.4 is installed as shown. If the cartridge filter is not installed, it must be installed before use, simply press it up over the motor cage as shown. Reposition and secure the cover/motor assembly to the tank with both cover latches.

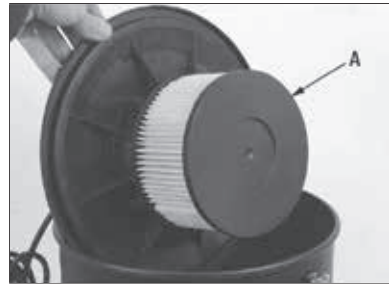

FIG. 4

INSTALLING HOSE & ALUMINUM NOZZLE FOR VACUUMING MODE

1. Attach one end of the hose (A) Fig.5 to the vacuum inlet port (B), secure the hose by inserting and turning it clockwise inside the inlet port.
2. Attach aluminum nozzle (C) Fig.5 to the other end of the hose (D).

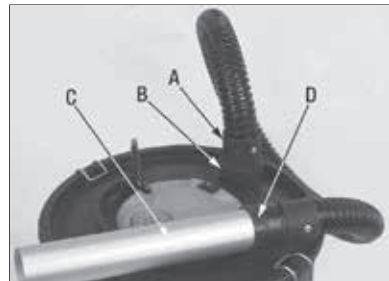

FIG. 5

INSTALLING HOSE & ALUMINUM NOZZLE FOR BLOWER MODE

1. Attach one end of the hose (A) Fig.6 to the blower outlet port (B), secure the hose by turning it clockwise inside the outlet port.
2. If desired, attach aluminum nozzle to the other end of the hose. Nozzle is not required for the Blower Mode.



FIG. 6

OPERATION

1. Before connecting the power cord to power source, make sure the vacuum is properly assembled with cartridge filter, hose and aluminum nozzle installed.

⚠ CAUTION: NEVER use the Ash Vacuum without the cartridge filter or aluminum nozzle installed.

2. Make sure the On/Off switch is in the “O” (OFF) position.
3. Place the Ash Vacuum near the fireplace or stove you are cleaning and **MAKE SURE THE ASH INSIDE IS COOL.**
4. Connect the power cord plug into power source near your work area and push the switch to the “I” (ON) position.
5. Using the aluminum nozzle only, begin vacuuming the ash.
6. As you vacuum, constantly check the nozzle, hose, tank, and motor for excessive temperatures. If you notice an increase in temperature, turn off the vacuum immediately.

Unplug the vacuum and remove the vacuumed material from the tank and cartridge filter. **ALLOW THE VACUUM AND THE MATERIAL TO BE VACUUMED TO COOL BEFORE CONTINUING TO VACUUM.**

IMPORTANT! Check the tank regularly to see if it is full.

7. Move the vacuum switch to the “O” (OFF) position, then unplug power cord from the power source.
8. Allow the vacuum to cool, then remove ash from the tank and clean the cartridge filter as explained in the “Maintenance” section below before storing the vacuum.

MAINTENANCE

⚠️ WARNING: To reduce the risk of injury and electrical shock, unplug the power cord from the power source. Airborn dust will be produced when cleaning, wear dust mask! To maintain peak vacuum performance, the cartridge filter must be cleaned often.

GENERAL MAINTENANCE AND INSPECTION

The inside of the tank, hose and aluminum nozzle should be cleaned after every use, this cleaning should only be done outdoors with the power cord disconnected from the power source. Check the condition of the power cord and make sure it is not damaged.

Cartridge Filter Maintenance

Inspect the cartridge filter for tears or holes; if any are found, replace the cartridge filter before reassembly of the Ash Vacuum.

DRY CLEANING METHOD ONLY. DO NOT hand wash with water or mild detergent. **DO NOT** machine wash/dry the cartridge filter!

To limit airborn dust, place cartridge filter inside a plastic bag. To clean cartridge filter tap it gently against a hard surface. Remove cartridge filter from the plastic bag and inspect it. Dust lodged within the filter pleats may require gentle flexing of the cartridge filter pleats to get deeply set dust out.

Cleaning the tank

1. Dump the cold ash inside the tank into an appropriate disposable container such as a plastic or paper trash bag.
2. To remove ash clinging to the tank interior, lightly wipe off the dust with paper towels or cloth rag.
3. Do not wash the tank with water, cleaning agent, or other liquid.

EXPLODED VIEW

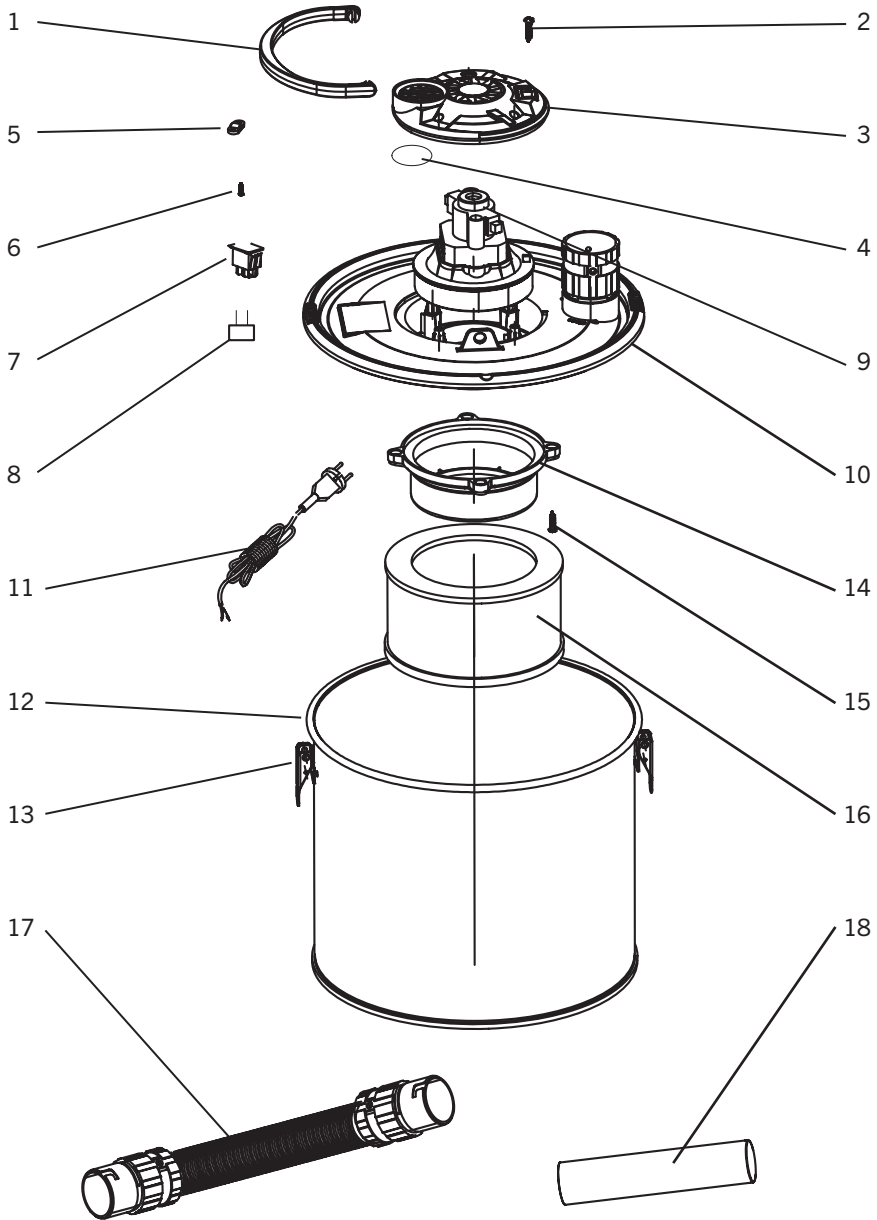

⚠ WARNING: When servicing, use only original equipment replacement parts. The use of any other parts may create a safety hazard or cause damage to the 18 L ash vacuum. Any attempt to repair or replace electrical parts on this 18 L ash vacuum may create a safety hazard unless repairs are performed by a qualified technician. For more information, call the Toll-free Helpline, at 1-866-349-8665; Monday - Friday: 9am to 5pm Eastern Standard Time.

PARTS LIST

Always order by key number.

KEY #	PART #	PART NAME / QUANTITY
1	1277-020-001	Handle / 1
2	1277-020-002	Top Cover Screws 4*16 / 4
3	1277-020-003	Top Cover / 1
4	1277-020-004	Top Cover Noise Proof Sponge / 1
5	1277-020-005	Press Board / 1
6	1277-020-006	Press Board Screws 4*16 / 2
7	1277-020-007	Switch / 1
8	1277-020-008	Capacitance / 1
9	1277-020-009	Motor / 1
10	1277-020-010	Bottom Cover / 1
11	1277-020-011	Cable / 1
12	1277-020-012	Tank / 1
13	1277-020-013	Clamp Set / 2
14	1277-020-014	Motor Cover / 1
15	1277-020-015	Motor Cover Screw 4*16 / 4
16	1277-020-016	Filter / 1
17	1277-020-017	1m Flex Hose / 1
18	1277-020-018	Aluminum Nozzle / 1

WARRANTY

VACUUM CLEANER

If this Benchmark tool fails due to a defect in material or workmanship within five years from the date of purchase, return it to any Home Hardware store with the original bill of sale for exchange. 3-year warranty for the battery and charger. This warranty does not include expendable parts including but not limited to blades, brushes, belts, light bulbs.

This warranty covers defects in material or workmanship only. It does not cover normal wear and tear, failure due to abuse/misuse, or defects caused by careless or accidental mishandling. If this Benchmark product is used for commercial or rental purposes, this warranty does not apply.

18 L ASH VACUUM



5 Year Limited Warranty on tool

BENCHMARKTM_{MC}

BENCHMARK TOOLS CANADA
ST. JACOBS, ONTARIO N0B 2N0
© 2021 Home Hardware Stores Limited

CUSTOMER SERVICE/TECH SUPPORT
1-866-349-8665

1277-020

Made in China



* This BenchmarkTM product carries a five (5) year LIMITED warranty against defects in workmanship and materials. See Owner's Manual for full details.



Intertek

5002219
JN019

**READ ALL INSTRUCTIONS BEFORE FIRST USE.
KEEP THIS MANUAL FOR FUTURE REFERENCE.
KEEP AWAY FROM CHILDREN.**

Not suitable for ultra-fine collection such as drywall dust.
Such use will void the warranty.



**WEAR CSA APPROVED
EYE PROTECTION**



**WEAR EAR
PROTECTION**



**WEAR A
FACE MASK**