

BENCHMARKTM MC

3-1/4" ELECTRIC PLANER



120V 60Hz 7.5Amp

5 year limited warranty on tool



Intertek
5015254
4823E

**READ ALL INSTRUCTIONS BEFORE FIRST USE.
KEEP THIS MANUAL FOR FUTURE REFERENCE.
KEEP AWAY FROM CHILDREN.**



**WEAR CSA APPROVED
EYE PROTECTION**



**WEAR EAR
PROTECTION**



**WEAR A
FACE MASK**

PRODUCT SPECIFICATIONS

ELECTRIC PLANER	
Rated Power	7.5A
Rated Voltage	120V~60 Hz
Planing Width	3-1/4" (82mm)
Planing Depth	1/8" (3mm) in 1/96" increments
Max Rabbetting depth	1" (24mm)
No-load speed	14,500 RPM
Tool Weight	7.9lbs (3.6kg)

NEED ASSISTANCE?

Call us on our toll- free customer support line:

1-866-349-8665 (Monday through Friday 9am – 5pm Eastern Standard Time)

- Technical questions
- Replacement parts
- Parts missing from package

TABLE OF CONTENTS

Product Specifications 1

Table of Contents 2

General Safety Warnings 3

General Power Tool Safety Warnings..... 5

Work Area Safety 5

Electrical Safety..... 5

Personal Safety 5

Specific Planer Safety Warnings 6

Safety Symbols 8

Know Your Electric Planer 9

Assembly 9

Operation 12

Maintenance 14

Exploded View 15

Parts List 16

Warranty 18







GENERAL SAFETY WARNINGS









IMPORTANT SAFETY INSTRUCTIONS

Read and understand all safety and operational instructions. Failure to follow the safety rules listed below and other basic safety precautions may result in serious personal injury. Keep this manual, sales receipts and applicable warranty forms for future reference.

SAFETY SYMBOLS

The purpose of safety symbols is to alert you of the potential safety RISKS. Recognize and understand them. Follow the instructions provided.

SYMBOL	MEANING
	Failure to obey a DANGER safety alert WILL result in serious personal injury or death to you or to others. Always obey all messages following this symbol to reduce the risk of serious personal injury or death.
	Failure to obey a WARNING safety alert MAY result in serious personal injury or death to you or to others. Always obey all messages following this symbol to reduce the risk of potential serious personal injury or death.
	Failure to obey a CAUTION safety alert MAY result in personal injury or property damage to you or to others. Always obey all messages following this symbol to reduce the risk of personal injury or property damage.
	Failure to obey a NOTICE or a CAUTION (without a safety alert) MAY result in property damage to you or to others. Always obey all messages following this symbol to reduce the risk of property damage.
	ALWAYS WEAR EYE PROTECTION THAT CONFORMS WITH CSA Z94.3 or ANSI SAFETY STANDARD Z87.1 FLYING DEBRIS can cause permanent eye damage. Prescription eyeglasses ARE NOT a replacement for proper eye protection. The usage of a safety standard compliant face shield placed over proper safety glasses or goggles can reduce the risk of facial injury. Non-compliant eyewear can cause serious injury if broken during the operation of a power tool.
	Use hearing protection, particularly during extended periods of operation of the tool, or if the operation is noisy.
	WEAR A DUST MASK THAT IS DESIGNED TO BE USED WHEN OPERATING A POWER TOOL IN A DUSTY ENVIRONMENT. Refer to Page 7 of the manual for California Prop 65 warnings relating to hazardous dust particles/

SYMBOL	MEANING
<p> WARNING</p> <p></p> <p></p> <p></p>	<p>Always wear non-slip gloves that fit properly to protect your hands and to help you grip the tool.</p> <p>Always wear sturdy clothing with long sleeves and long pants. Never operate the tool while wearing shorts, short sleeve shirt or while shirtless.</p> <p>Always wear non-slip safety boots to prevent foot injuries and slipping that could cause loss of control of the tool.</p>
<p> WARNING</p> <p></p>	<p>To avoid electrical hazards, fire hazards or damage to the tool, use proper circuit protection.</p> <p>This tool is wired at the factory for 120 V AC operations. It must be connected to a 120 V AC, 15 A circuit that is protected by a time-delayed fuse or circuit breaker. To avoid shock or fire, replace power cord immediately if it is worn, cut or damaged in any way.</p>
<p> WARNING</p> <p></p>	<p>WARNING: Ventilation openings in batteries and chargers must always be open to allow cooling air to circulate freely. Air vents that are blocked, restricted or covered may result in the battery or charger overheating. Overheating may lead to damage to the tool or cause a fire, resulting in possible serious injury.</p>

GENERAL POWER TOOL SAFETY WARNINGS

Read all safety warnings and all instructions. Failure to follow the warnings and instructions may result in electric shock, fire and/or serious injury.

Save all warnings and instructions for future reference. The term “power tool” in the warnings refers to your mains operated (corded) power tool or battery-operated (cordless) power tool.

WORK AREA SAFETY

- Keep work area clean and well lit. Cluttered or dark areas invite accidents.
- Do not operate power tools in explosive atmospheres, such as in the presence of flammable liquids, gases or dust. Power tools create sparks which may ignite the dust or fumes.
- Keep children and bystanders away while operating a power tool. Distractions can cause you to lose control.

ELECTRICAL SAFETY

- Power tool plugs must match the outlet. Never modify the plug in any way. Do not use any adapter plugs with earthed (grounded) power tools. Unmodified plugs and matching outlets will reduce risk of electric shock.
- Avoid body contact with earthed or grounded surfaces, such as pipes, radiators, ranges and refrigerator. There is an increased risk of electric shock if your body is earthed or grounded.
- Do not expose power tools to rain or wet conditions. Water entering a power tool will increase the risk of electric shock.
- Do not abuse the cord. Never use the cord for carrying, pulling or unplugging the power tool. Keep cord away from heat, oil, sharp edges and moving parts. Damaged or entangled cords increase the risk of electric shock.
- When operating a power tool outdoors, use an extension cord suitable for outdoor use. Use of a cord suitable for outdoor use reduces the risk of electric shock.
- If operating a power tool in a damp location is unavoidable, use a residual current device (RCD) protected supply. Use of an RCD reduces the risk of electric shock.

PERSONAL SAFETY

- Stay alert, watch what you are doing and use common sense when operating a power tool. Do not use a power tool while you are tired or under the influence of drugs, alcohol or medication. A moment of inattention while operating power tools may result in serious personal injury.
- Use personal protective equipment. Always wear eye protection. Protective equipment such as dust mask, non-skid safety shoes, hard hat, or hearing protection used for appropriate conditions will reduce personal injuries.
- Prevent unintentional starting. Ensure the switch is in the off-position before connecting to power source and/or battery pack, picking up or carrying the tool. Carrying power tools with your finger on the switch or energising power tools that have the switch on invites accidents.

- Remove any adjusting key or wrench before turning the power tool on. A wrench or a key left attached to a rotating part of the power tool may result in personal injury.
- Do not overreach. Keep proper footing and balance at all times. This enables better control of the power tool in unexpected situations.
- Dress properly. Do not wear loose clothing or jewellery. Keep your hair, clothing and gloves away from moving parts. Loose clothes, jewellery or long hair can be caught in moving parts.
- If devices are provided for the connection of dust extraction and collection facilities, ensure these are connected and properly used. Use of dust collection can reduce dust-related hazards.

POWER TOOL USE AND CARE

- Do not force the power tool. Use the correct power tool for your application. The correct power tool will do the job better and safer at the rate for which it was designed
- Do not use the power tool if the switch does not turn it on and off. Any power tool that cannot be controlled with the switch is dangerous and must be repaired.
- Disconnect the plug from the power source and/or the battery pack from the power tool before making any adjustments, changing accessories, or storing power tools. Such preventive safety measures reduce the risk of starting the power tool accidentally.
- Store idle power tools out of the reach of children and do not allow persons unfamiliar with the power tool or these instructions to operate the power tool. Power tools are dangerous in the hands of untrained users.
- Maintain power tools. Check for misalignment or binding of moving parts, breakage of parts and any other condition that may affect the power tool's operation. If damaged, have the power tool repaired before use. Many accidents are caused by poorly maintained power tools.
- Keep cutting tools sharp and clean. Properly maintained cutting tools with sharp cutting edges are less likely to bind and are easier to control.
- Use the power tool, accessories and tool bits etc. in accordance with these instructions, taking into account the working conditions and the work to be performed. Use of the power tool for operations different from those intended could result in a hazardous situation.

SERVICE

- Have your power tool serviced by a qualified repair person using only identical replacement parts. This will ensure that the safety of the power tool is maintained.

PLANER SAFETY RULES

- Wait for the cutter to stop before setting the tool down. An exposed rotating cutter may engage the surface leading to possible loss of control and serious injury.
- Hold the power tool by insulated gripping surfaces only, because the cutter may contact its own cord. Cutting a "live" wire may make exposed metal parts of the power tool "live" and could give the operator an electric shock.

- Use clamps or another practical way to secure and support the workpiece to a stable platform. Holding the work by your hand or against the body leaves it unstable and may lead to loss of control.
- Use suitable detectors to determine if utility lines are hidden in the work area or call the local utility company for assistance. Contact with electric lines can lead to fire and electric shock. Damaging a gas line can lead to explosion. Penetrating a water line causes property damage or may cause an electric shock.
- Do not reach into the chip ejector with your hands. They could be injured by rotating parts.
- Apply the machine to the workpiece only when switched on. Otherwise there is danger of kickback when the cutting tool jams in the workpiece.
- When working, always hold the planer in such a manner that the planer base plate faces flat on the workpiece. Otherwise the planer can become wedged and lead to injuries.
- Never plane over metal objects, nails or screws. The planer blade and the blade shaft can become damaged and lead to increased vibrations.
- Always start the planer before blade is in contact with the workpiece and allow the blade to come to full speed before contacting the workpiece. The tool can vibrate or chatter if the blade speed is too slow at beginning of the cut and can possibly kick back.
- Check the workpiece for nails. If there are nails, either remove or set them well below intended finished surface. If the planer blades strike objects like nails it may cause the tool to kick back and serious personal injury may result.
- Unplug the planer before changing accessories. Before plugging the tool in, check that the trigger lock is “OFF”. Accidental start-ups may occur if planer is plugged in while changing an accessory.
- Always hold the tool firmly with both hands for maximum control.
- Never pull the plane backward over the workpiece. Loss of control may occur.
- Always wear ear and eye protection and a breathing mask.

SAVE THIS USER MANUAL











WARNING

MISUSE or failure to follow the safety rules stated in this instruction manual may cause serious personal injury.

MINIMUM GAUGE (AWG) EXTENSION CORD (120 V use only)					
Amperage rate		Total length			
More than	Not more than	25' (7.5 m)	50' (15 m)	100' (30 m)	150' (45m)
0	6	18	16	16	14
6	10	18	16	14	12
10	12	16	16	14	12
12	16	14	12	Not Applicable	

SAFETY SYMBOLS

The rating plate on your tool may show symbols. These represent important information about the product or instructions on its use.

	WARNING: Please read all of the safety and operating instructions carefully before using this tool. Please pay particular attention to all sections of this User Guide that carry warning symbols and notices. Some of the following symbols may be used on this tool.
	Observe caution and safety notes.
	To reduce the risk of injury, user must read and understand User Guide before using this tool.
	Wear ear protection.
	Wear protective helmet and eye protection.
	Switch off and remove plug from power source before cleaning or maintenance.
	Do not use in the rain or leave outdoors while it is raining.
	Keep bystanders away.
	Don't touch the inlet and outlet when the vacuum cover is opened or the tube is removed.
	Double insulation.
	Remove plug from the power source immediately if the power cord is damaged or cut.



This symbol designates that this tool is listed with Canadian and U.S. requirements by ETL Testing Laboratories, Inc.
Conforms to UL Std. 62841-1:2015 and 62841-2-14:2016
Certified to the CAN/CSA Std. C22.2 No. 62841-1:2015 and 62841-2-14:2016

KNOW YOUR ELECTRIC PLANER

⚠ ATTENTION

Always be sure that the tool is switched off and unplugged before making any adjustments to the tool.

1. Depth adjustment knob (insulated)
2. Planing depth scale
3. Planer base plate
4. Lock off safety switch
5. On/Off switch
6. Dust bag/chip extraction port
7. Rabbeting depth stop

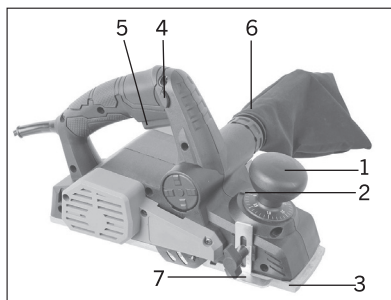

ASSEMBLY

STARTING/STOPPING TOOL & LOCK-OFF BUTTON

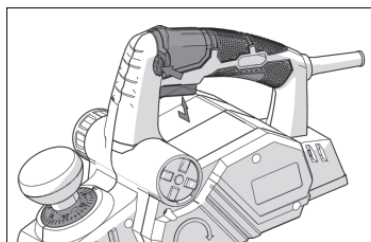
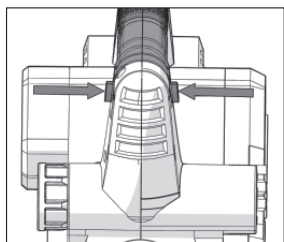

1. Connect the power cord of your planer to a standard household power outlet.
2. To turn the planer ON, hold the tool with both hands, push in the lock-off button first from either left or right side, and then press the on/off trigger switch.
3. To turn the planer OFF, release the trigger switch.

ADJUSTING THE RATCHETING DEPTH KNOB - ADJUSTING DEPTH OF CUT

The proper cutting depth should be determined according to the hardness, gumminess or moisture content of the material being cut, as well as the feed rate, and is largely a matter of experience. Rotate the depth adjustment knob clockwise for a deeper cut and counter-clockwise for a shallower cut.

The numbers on the ring under the depth adjustment knob indicate the depth of cut. If it is necessary to accurately determine the depth of cut, plane a scrap piece of wood, measure the difference in thickness and adjust the setting.

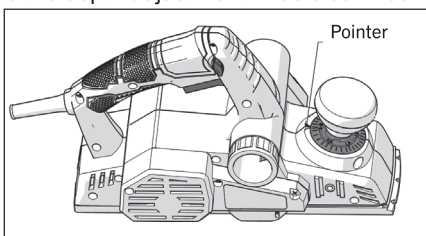

⚠ATTENTION

- Do not press the On/Off button forcefully without pressing the lock off button, which may cause the On/Off button to break.

SUPPORTING FOOT

1. Front base plate
2. Blade drum
3. Back base plate
4. Supporting foot

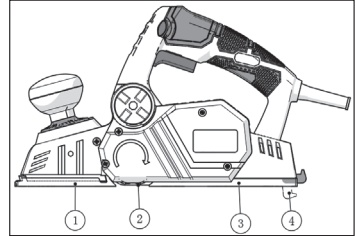

1. After the cutting operation is completed, the support foot can lift the rear side of the planer to prevent damage to the blade.
2. When pushing the planer, the support foot will rotate to the position flush with the work surface. As shown above.

INSTALLING OR REMOVING PLANER BLADE

⚠ATTENTION

1. Before installing or removing the planer blade, please turn off the tool power switch and unplug the power.
2. Tighten the blade bolts carefully when attaching the blades to the tool. A loose bolt can be dangerous. Always check to see they are tightened securely.
3. Handle the blades very carefully. Use gloves or rags to protect your fingers or hands when removing or installing the blades.
4. Use only the Benchmark wrench provided to remove or install the blades. Failure to do so may result in overtightening or insufficient tightening of the installation bolts. This could cause an injury.
5. Use only blades designated for use with this model, because other blades will cause vibration, decrease performance and may not clamp securely in the blade holder.

1. Hex key
2. Hex bolt
3. Socket wrench
4. Hex socket screw
5. Blade baffle
6. Small wooden stick
7. Blade holder
8. Blade

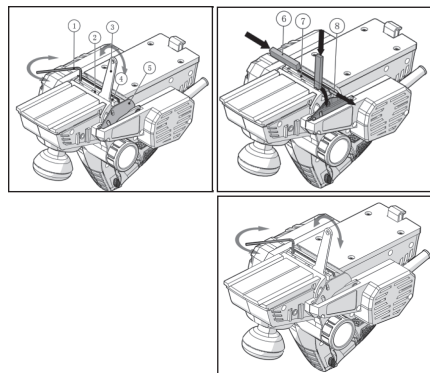

1. To remove the blade on the blade shaft, first turn the planer upside down on the workbench or a flat surface with the blade facing the operator, ensure the tool is unplugged, then turn the blade shaft by hand to expose the screw, and then remove the screw. First use the socket wrench to turn the three hex bolts counterclockwise, and use the hex key to turn the two hex socket screws counterclockwise. Then push the blade from the side with a wooden stick, to remove the blade from the blade shaft.
2. To install the blades, first clean out all chips or foreign matter adhering to the drum or blades. Use blades of the same dimensions and weight, or drum oscillation/vibration will result, causing poor planing action and, eventually, tool breakdown.
3. Carbide inserts have two cutting edges that can be inverted for use on the other side. When both cutting edges are blunt, the blade must be replaced.
4. Please pay attention, to install the blade in the groove of the cutter shaft, use a hex key to pre-tension the three bolts. Then install the blade with a small wooden stick to ensure that the edge of the blade is aligned with the backplane. Check this alignment carefully to ensure uniform cutting. Finally, use the socket wrench to evenly and evenly tighten all mounting bolts clockwise.
5. Check the three hex flange head bolts for final tightness.
6. Repeat procedures 1 - 5 for other blade.

PLANER BLADE ADJUSTMENT

⚠ ATTENTION When installing the blade on the tool, carefully tighten the blade hex bolt. If the hex bolt is loose, it can be dangerous and can cause damage to the tool or injury to people. So please check to see if they are all tightened.

1. Your planing surface will end up rough and uneven, unless the blade is set properly and securely. The blade must be mounted so that the cutting edge is absolutely level, that is, parallel to the surface of the rear base.

Below are some examples of proper and improper settings:

A Front base (Movable shoe) B Rear base (Stationary shoe)

Correct setting 

Although this side view cannot show it, the edges of the blades run perfectly parallel to the rear base surface.

Nicks in surface 

Cause: One or both blades fails to have edge parallel to rear base line.

Gouging at start 

Cause: One or both blade edges fails to protrude enough in relation to rear base line.

Gouging at end 

Cause: One or both blade edges protrudes too far in relation to rear base line.

DUST BAG AND VAC ADAPTER ASSEMBLY AND USE

1. Dust/chip extraction port
2. Dust bag
3. Dust bag zipper
4. Exhaust dust tube
5. Vacuum adapter

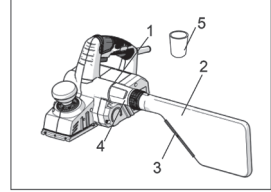

Before using the tool with either the dust bag or a shop vac, you must first install the exhaust dust tube on either side of the tool as follows: To Install the exhaust dust tube (4): Align the raised embossed end on the exhaust dust tube with the groove in the dust/chip extraction port (1), and slide the exhaust dust tube into the port. Then rotate the exhaust dust tube to lock it in place. When planing smaller jobs, attach the dust bag to the dust/chip extraction port, if using a shop vac, install the exhaust dust tube onto the tool as noted above, attach vac adapter to the exhaust dust tube and then attach your shop vac hose to the adapter. Ensure you wear a suitable dust mask, as there may be some residual airborne dust particles in the area. To detach the bag, turn clock-wise and pull it out from the port. Empty the dust bag: Empty the dust bag by unzipping the bag (3) and then gently tap the bag to remove the dust.

For a more thorough cleaning of the dust bag, slip the bag off of the frame and turn bag inside out. Use a soft brush to brush the dust off of the lining.

OPERATION**PLANING**

1. Unplug the planer and adjust the edge guide and cutting depth as appropriate.
2. Clamp the workpiece securely on a workbench.
3. Connect the power cord of your planer to a standard household power outlet.
4. While standing comfortably, hold the planer firmly with both hands (1) & (2).

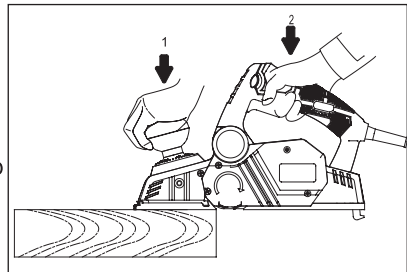

5. Place the front base of the planer against the workpiece surface without the blades making any contact with the workpiece.
6. Switch on the tool and guide the tool with even feed over the surface to be planed.
7. Move the tool gently forward, applying pressure on the front of the tool at the beginning of the planing pass and pressure at the rear of the tool at the end of the planing pass.
8. Push the planer beyond the edge of the workpiece without tilting it downwards.

The rate of planing and the depth of cut determine the quality of the cut. For rough cutting, you can increase the depth of cut. To achieve a smooth cut, you will need to reduce the depth of cut and advance the planer slowly across the workpiece. The proper feed rate will depend on the type of material being cut and the depth of the cut. When planing hard materials (e.g., hardwood), as well as when utilizing

the maximum planer width, set only low planing depths and reduce the planer feed as required. Practice first on a scrap piece of material to gauge the correct feed rate and the cut dimensions.

NOTE: Planing is easier if you incline the workpiece slightly away from you so that you plane “downhill”.

- Moving the planer too quickly may cause a poor quality of cut and can damage the blades or the motor. Moving the planer too slowly may burn or mar the workpiece.

WARNING!

- Hold the tool with both hands while starting the tool, since torque from the motor can cause the tool to twist.

CAUTION!

- Always use two hands when holding the planer.
- Wherever possible, clamp the workpiece to a workbench or clamping table.

EDGE GUIDE

1. To attach the edge guide, remove the edge-guide attachment knob and slide the edge guide into the planer.
2. Replace the edge-guide attachment knob and firmly tighten it.
3. Loosen the locking nut and slide the edge guide to the desired position. Securely tighten the locking nut.

RABBETTING DEPTH STOP

The rabbetting depth stop allows the user to set any rabbetting depth to a maximum of (1") 24mm. For best results, it is important that the blade be properly aligned with the front base. The width of the rabbet is controlled by the edge guide and the final depth is achieved by repeating the planing procedure until the rabbetting depth stop contacts the workpiece.

RABBETTING

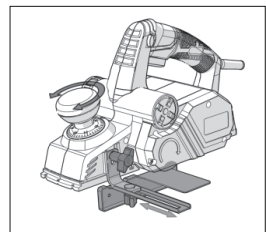
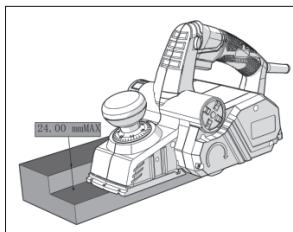
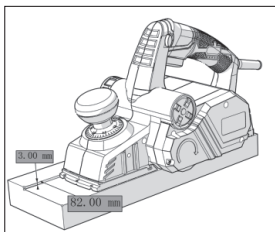

1. To make a stepped cut as shown in the figure, use the edge guide.
2. Draw a cutting line on the workpiece. Insert the edge guide into the hole in the front of the tool. Align the blade edge with the cutting line.
3. Adjust the edge guide until it comes in contact with the side of the workpiece, then secure it by tightening the screw.

- When planing, move the tool with the edge guide flush with the side of the workpiece. Otherwise uneven planing may result.

CHAMFERING

The "V" groove in the front base allows quick and easy chamfering of workpiece edges as shown in image.

- Place the "V" groove on the front base over the edge to be chamfered. Be sure the blades are not touching the workpiece.
- Position the "V" groove absolutely flat on the edge to be bevelled.
- Grasp the tool firmly with both hands, turn the tool on and push the planer forward with steady pressure on the front base.

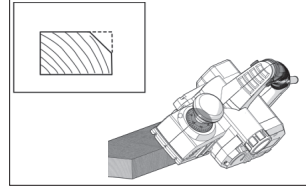

INSTALLING NEW DRIVE BELT

- Large driven pulley
- Motor pulley
- Drive belt cover
- Screws

The drive belt is a normal maintenance part and should be inspected periodically for wear. If the drive belt shows signs of drying out, cracking or tearing, it should be replaced. If the drive belt will not track properly or comes off the pulleys, it should be replaced.

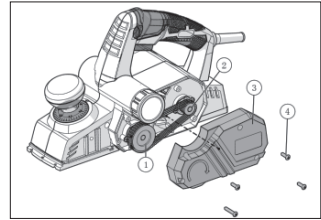

- Disconnect the plug from the power source.
- Loosen the three screws with a cross-head screwdriver and remove the drive belt cover - see image above.
- Cut and remove the worn drive belt. Before installing the new drive belt, clean both pulleys thoroughly.
- Place the new drive belt onto the driven pulley then rotate it clockwise while pushing the belt onto the drive pulley.
- Reinstall the drive belt cover and securely tighten screws.

MAINTENANCE

- Before performing any maintenance on this tool ensure the planer is unplugged.
- For safe and proper operation, always keep the planer and planer ventilation slots clean and free from debris.

EXPLODED VIEW

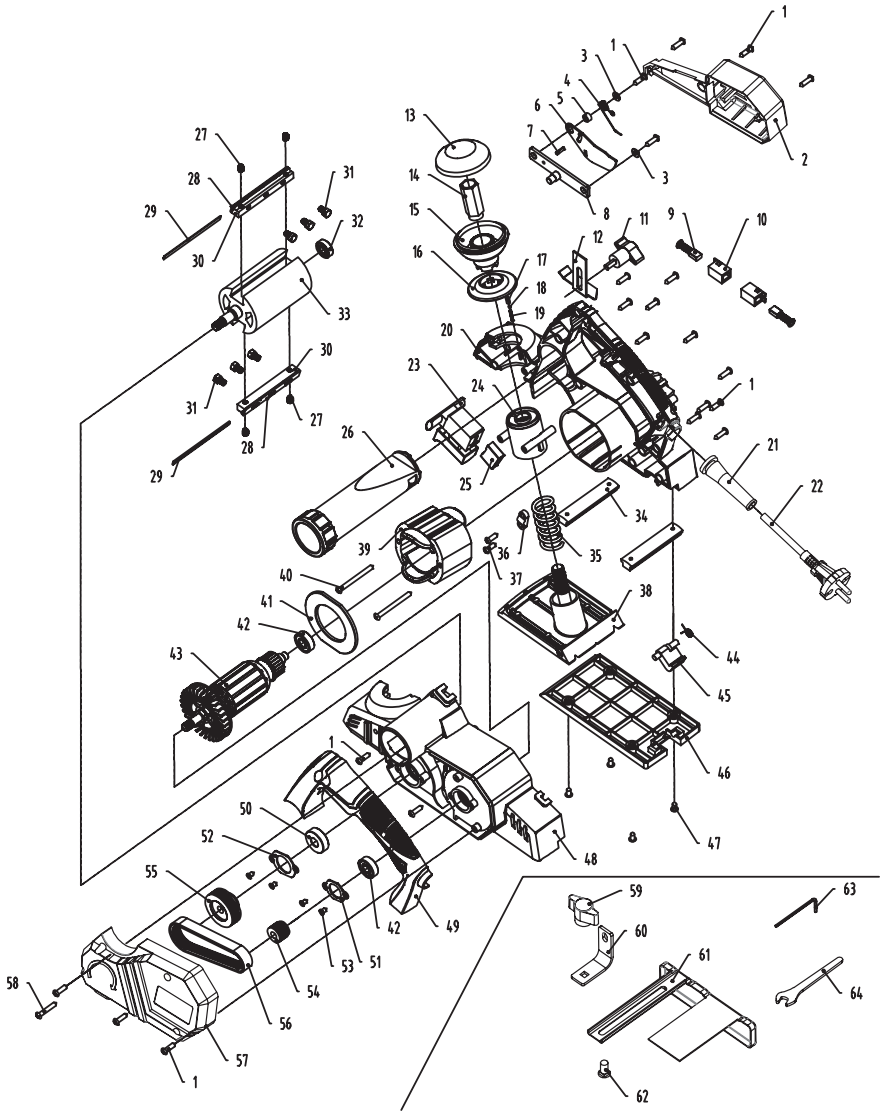

PARTS LIST

⚠ WARNING: When servicing, use only original equipment replacement parts. The use of any other parts may create a safety hazard or cause damage to the electric planer.

Any attempt to repair or replace electrical parts on this planer may create a safety hazard unless repairs are performed by a qualified technician.

For more information, call the Toll-free Helpline, at 1-866-349-8665;
Monday - Friday: 9am to 5pm Eastern Standard Time.

Always order by key number.

Key#	Part #	Part Name	Qty
1	1260-201-001	SCREW ST4X16	21
2	1260-201-002	REAR COVER	1
3	1260-201-003	WASHER Φ 4X Φ 9X1	1
4	1260-201-004	SPRING	1
5	1260-201-005	AXLE SLEEVE	1
6	1260-201-006	SAFETY SCREEN	1
7	1260-201-007	SPRING PIN 4X10	1
8	1260-201-008	SHAFT ASSEMBLY	1
9	1260-201-009	CARBON BRUSH	2
10	1260-201-010	HOLDER OF CARBON BRUSH	2
11	1260-201-011	BUTTERFLY NUT	2
12	1260-201-012	DEPTH OF PARALLEL GUIDE	1
13	1260-201-013	KNOB CAP	1
14	1260-201-014	ADJUSTMENT KNOB	1
15	1260-201-015	RETAINER	1
16	1260-201-016	SCALE	1
17	1260-201-017	BULLET	1
18	1260-201-018	STEEL BALL Φ 2.5	2
19	1260-201-019	SPRING	1
20	1260-201-020	HOUSING - RIGHT	1
21	1260-201-021	CORD GUARD	1
22	1260-201-022	CORD WITH PLUG	1
23	1260-201-023	SWITCH	1
24	1260-201-024	GUIDE SLEEVE	1
25	1260-201-025	CAPACITANCE	1
26	1260-201-026	EXHAUST DUST TUBE	1
27	1260-201-027	SCREW M5X8	4
28	1260-201-028	PATAND	2

Key#	Part #	Part Name	Qty
29	1260-201-029	BLADE	2
30	1260-201-030	HOLDER OF BLADE	2
31	1260-201-031	SCREW M5X8	6
32	1260-201-032	BALL BEARING 607	1
33	1260-201-033	BLADE SUPPORT ROLLER	1
34	1260-201-034	COMPRESSION PLATE	2
35	1260-201-035	COMPRESSION SPRING	1
36	1260-201-036	CABLE CLAMP	1
37	1260-201-037	SCREW ST4X14	2
38	1260-201-038	FRONT BASE	1
39	1260-201-039	STATOR	1
40	1260-201-040	SCREW ST4X55	2
41	1260-201-041	BAFFLE FAN	1
42	1260-201-042	BALL BEARING 608	2
43	1260-201-043	ARMATURE	1
44	1260-201-044	TORSION SPRING	1
45	1260-201-045	FOOT	1
46	1260-201-046	REAR BASE	1
47	1260-201-047	SCREW ST4X10	4
48	1260-201-048	HOUSING-LEFT	1
49	1260-201-049	HANDLE COVER	1
50	1260-201-050	BALL BEARING 6000	1
51	1260-201-051	BEARING COVER 608	1
52	1260-201-052	BEARING COVER 6000	1
53	1260-201-053	SCREW ST4X12	4
54	1260-201-054	MOTOR PULLEY	1
55	1260-201-055	DRIVEN PULLEY	1
56	1260-201-056	BELT	1
57	1260-201-057	BELT COVER	1
58	1260-201-058	SCREW ST4X25	1
59	1260-201-059	BUTTERFLY NUT	1
60	1260-201-060	HOLDER OF PARALLEL GUIDE	1
61	1260-201-061	PARALLEL GUIDE	1
62	1260-201-062	M6X10 SQUARE NECK BOLT	1
63	1260-201-063	INTERNAL HEXAGONAL WRENCH	1
64	1260-201-064	GUIDE SLEEVE	1

WARRANTY

BENCHMARK ELECTRIC PLANER

If this Benchmark tool fails due to a defect in material or workmanship within five years from the date of purchase, return it to any Home Hardware store with the original bill of sale for exchange. 3-year warranty for the battery and charger. This warranty does not include expendable parts including but not limited to blades, brushes, belts, light bulbs.

This warranty covers defects in material or workmanship only. It does not cover normal wear and tear, failure due to abuse/misuse, or defects caused by careless or accidental mishandling. If this Benchmark product is used for commercial or rental purposes, this warranty does not apply.

3-1/4" ELECTRIC PLANER



5 year limited warranty on tool

BENCHMARK™
MC

BENCHMARK TOOLS CANADA
ST. JACOBS, ONTARIO N0B 2N0
© 2021 Home Hardware Stores Limited

CUSTOMER SERVICE/TECH SUPPORT
1-866-349-8665

1260-201

Made in China



* This Benchmark™ product carries a five (5) year LIMITED warranty against defects in workmanship and materials. The charger and batteries carry a three (3) year LIMITED warranty. See Owner's Manual for full details.



Intertek

5015254
4823E

**READ ALL INSTRUCTIONS BEFORE FIRST USE.
KEEP THIS MANUAL FOR FUTURE REFERENCE.
KEEP AWAY FROM CHILDREN.**



**WEAR CSA APPROVED
EYE PROTECTION**



**WEAR EAR
PROTECTION**



**WEAR A
FACE MASK**