

# SETTING UP YOUR RECEIVER WITH TAILGATER



[www.dish.com/tailgater](http://www.dish.com/tailgater)

First-time connection of your Tailgater should be performed at your residence or a location where you have good phone reception. When your Tailgater system is set up, call DISH Network at 1-800-333-DISH (3474) to activate your receiver and begin viewing your satellite programming.

Power on the system and perform the setup procedure at least once every two months if your Tailgater is not used for extended periods of time.

## 1. Before You Leave Home

Make sure your Tailgater antenna is packed securely for transport. Don't forget the following items:

- A portable power generator or an AC/DC power inverter
- Power extension cord
- Power strip for your receiver and TV
- Tailgater compatible DISH Network HD Receiver (ViP 211k)
- Audio and video cable(s)
- Supplied coaxial cable

## 2. Setup Your Tailgater

Your Tailgater requires an unobstructed view of the southern sky for the best signal reception. Be sure to place the Tailgater in a location free from obstructions such as people, trees, buildings, or vehicles. This will allow for the strongest signal and will help prevent any interruption to your programming. Follow the steps below to begin using your Tailgater.



## 3. Install Batteries in Your Remote

Remove the remote battery cover and verify fresh batteries (included) are installed. Replace the battery cover.

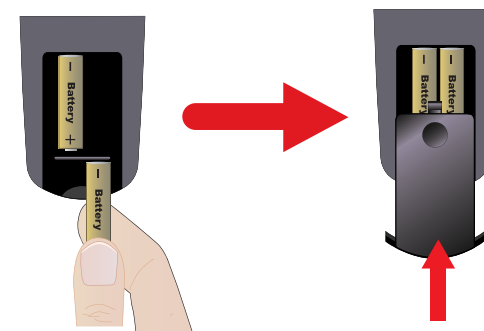

## 4. Connect Your Cables to Your TV

Connect your receiver to the TV using the best connection type supported by your television. You only need to select one of the connections below for audio and video.

HDMI Cable

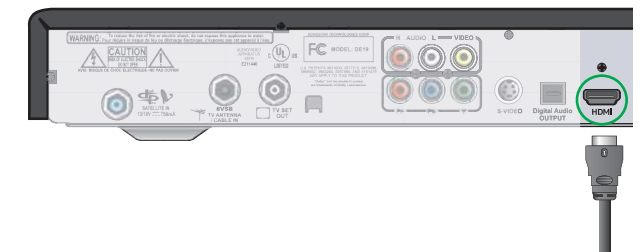

OR

Component Cables

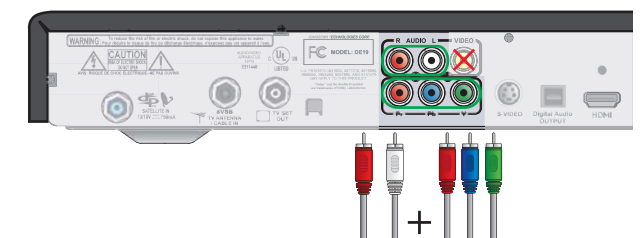

The standard definition audio and video ports can also be used to view your programming. See your receiver User's Guide for more information.

## 5. Connect Your Tailgater

a. Connect one end of the coaxial cable (included) to the coaxial port on the Tailgater.

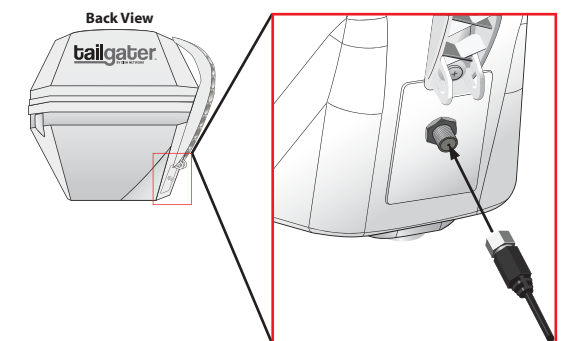

b. Connect the other end of the coaxial cable to the "Satellite In" coaxial port on the back of the DISH Network HD Solo Receiver.

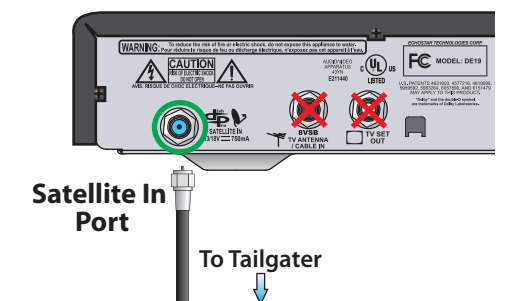

# SETTING UP YOUR RECEIVER WITH TAILGATER



## 6. Power Up System

a. Plug in your receiver to a 110V power source.

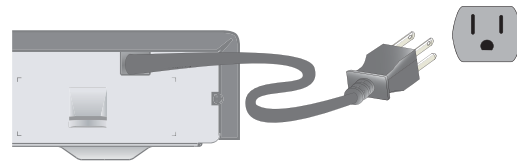

b. The green power light on your receiver should be lit or begin cycling on and off. Wait for the green light to turn solid.

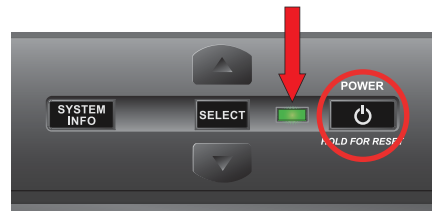

*If the green power light does not turn solid within two minutes, power on your receiver using the front panel POWER button.*

c. Turn on your TV. The "Portable Antenna Setup" screen displays. This may take up to two minutes.



Your TV should be set to display input from the cable(s) you selected in step 4. Consult your TV user's manual to select the correct input.

*If the "Portable Antenna Setup" screen does not display, press MENU, 6, 1, 1 on your remote. Verify the Check Switch button is highlighted then press SELECT on your remote.*

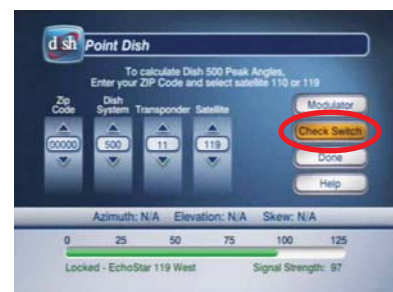

## 7. Scan for Receiver Signal

Your Tailgater requires an unobstructed view of the southern sky for the best signal reception. Verify the Tailgater is in a location free from obstructions such as people, trees, buildings, vehicles, etc. This will allow for the strongest signal and will help prevent any interruption to the scan.

a. Use your remote to select the state you are currently located in from the "Portable Antenna Setup" screen. Verify the **Scan** button is highlighted, then press SELECT on your remote.

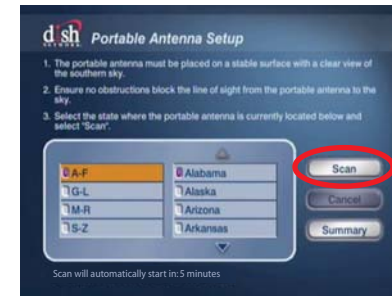

*The scan may take several minutes to complete.*

The "Attention" message displays.



b. When the scan is complete, the "Acquiring Signal" message displays. This process may take up to 5 minutes to complete.

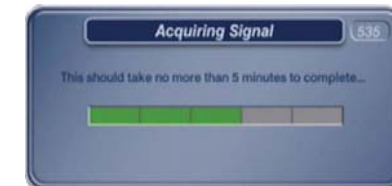

*If the signal acquisition was unsuccessful, verify there is nothing blocking the Tailgater's view of the southern sky and the coaxial cable is connected. Then, unplug the receiver power cord for 10 seconds and plug it back in. It may take up to 5 minutes for the receiver to power back on.*

c. After the receiver has acquired the signal, the electronic program guide downloads to your receiver.

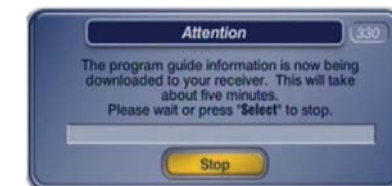

*The download may take up to 5 minutes to complete. (Potentially longer if an external hard drive is connected.)*

d. Your setup and activation were successful when television programming becomes available.



Check a few different channels to verify that all of your television programming is available. If necessary, call DISH Network at 1-800-333-DISH (3474) to activate your receiver.

## FAQs

### Can I run my Tailgater antenna, DISH receiver, and TV from my vehicle?

Yes, you can use an inverter to power your system from your vehicle's DC power supply (12V power outlet). If you plan to watch TV for more than a few hours, be sure to start and run your vehicle for a few minutes every hour. A portable power generator or alternative accessory battery may also be a better option for operating your system.

### Will my Tailgater work during inclement weather?

Though rare, heavy rain, snow, or dense cloud cover can reduce the satellite signal, which may interrupt your programming. Your programming will return as conditions improve.

### Can I add DVR functionality (record and pause live TV) to my receiver?

Your receiver has a port on the back where you can attach a USB external hard drive, adding DVR functionality for a one-time service fee of \$40. For more information or to see if your receiver is applicable, go to [www.dishnetwork.com/supportsection/dvrconversion](http://www.dishnetwork.com/supportsection/dvrconversion).

### Where can I go for additional assistance with my Tailgater?

If any trouble develops that is not addressed by the Troubleshooting tips in your User's Guide, you should go to [www.dish.com/support](http://www.dish.com/support) or contact DISH Network at 1-800-333-DISH (3474).

### How do I keep my Tailgater from being stolen?

To prevent theft, your Tailgater has a security bracket located at the bottom of the carry handle. Secure your Tailgater to a fixed object using a padlock and security cable (not included).

### Is my Tailgater compatible with a different model receiver?

Please visit [www.dish.com/tailgater](http://www.dish.com/tailgater) for a complete list of compatible receiver models available from DISH Network and more information about the Tailgater.

## Troubleshooting

For more troubleshooting symptoms, please refer to your Tailgater User's Guide or visit [www.dish.com/tailgater](http://www.dish.com/tailgater).

Symptom/Message	Possible Cause	Troubleshooting
Complete Signal Loss - 015	Obstructions to the antenna's view of the southern sky, such as tree branches, severe rain, etc.	1) Make sure nothing is blocking your portable antenna's view of the southern sky, such as tree branches, severe rain, or other obstructions.
Partial Signal Loss - 002	Cabling not connected properly between the DISH receiver and the portable antenna.	2) Check that the coax between your DISH receiver and the portable antenna is connected properly. 3) Unplug the power cord of your receiver for 10 seconds and plug it back in. It may take up to 5 minutes for the receiver to power back on.
All Satellites Not Found - 150	Obstructions to the antenna's view of the southern sky, such as tree branches, severe rain, etc. Your physical location may be outside the footprint of the desired orbital slot.	1) Make sure nothing is blocking your portable antenna's view of the southern sky, such as tree branches, severe rain, or other obstructions. 2) Unplug the power cord of your receiver for 10 seconds and plug it back in. It may take up to 5 minutes for the receiver to power back on.
My remote is not working	Your remote is not currently paired with your receiver.	1) Check to make sure the batteries are properly inserted in your remote. 2) Set up your remote control: • Press the "SYSTEM INFO" button on the front panel of your receiver. The "System Info" screen displays. • Press and release the SAT button on your remote control. • Press and release the RECORD button. You may see the remote address change on the screen. • Press and release the SELECT button on your remote to continue.